

BIG WHITE®

SLV CATALOGO ILLUMINAZIONE 2024













RIMANI AGGIORNATO

Inquadra il codice QR e seleziona il paese per conoscere i nostri prezzi aggiornati.
Ci trovi su **slv.com**







FAMIGLIE IN EVIDENZA

NUMINOS®	82
NEW TRIA®	122
MEDO®	148
LALU®	176
ONE®	186

PER INTERNI

 Incassi	202
 Lampade a plafone	248
 Sospensioni	278
 Lampade da parete	320
 Lampade da parete e a plafone	390
 Lampade da tavolo e da terra	434
 Binario a 48V	454
 Tesata a bassa tensione	480
 Binario monofase ad alta tensione	492
 Binario trifase ad alta tensione	524
 Soluzioni di profili e LED Strip	564

PER ESTERNI

 Lampade mobili e lampade da terra	594
 Faretti	686
 Lampade da parete	704
 Lampade a plafone	786
 Lampade da parete e a plafone	802
 Incassi	818
 Incassi a terra	828

ACCESSORI

 Sorgenti luminose	858
 Accessori	866

NAVIGAZIONE

Editoriale e riferimenti	4
Indice per applicazione	14
Indice delle famiglie	46
Indice numerico	882
Indice alfabetico	892

NUOVA NAVIGAZIONE

PANORAMICA CATEGORIE

Tutto a colpo d'occhio. Trova gli apparecchi giusti in base alle categorie.



PANORAMICA FAMIGLIE

Scopri tutti gli apparecchi della stessa famiglia per un progetto di illuminazione completo.

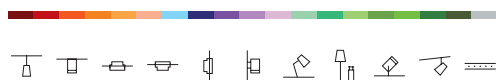

CATEGORIE PRODOTTI

Sapersi orientare. Le nuove icone e colori ti consentono di navigare rapidamente e facilmente nelle rispettive categorie di prodotti.



CONSIGLI

Facile e veloce. Scoprite gli accessori e le sorgenti luminose abbinabili ai prodotti selezionati.

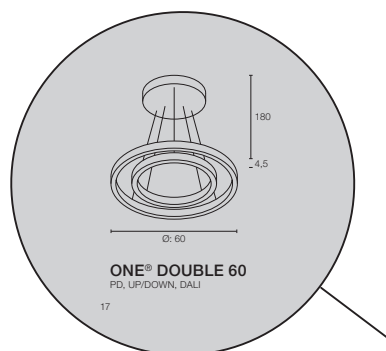

ATTENZIONE

Tutte le misure sono espresse in **cm**.

GUIDA CHIARA

Nella nuova sezione dei consigli, tutte le informazioni rilevanti sull'illuminazione e sui prodotti SLV sono spiegate in modo chiaro e conciso.

Dalle guide alla progettazione alle illustrazioni del sistema fino alle conoscenze sull'illuminazione, apprenderai tutto in questo BIG WHITE®. Mentre lo sfogli, cerca le pagine gialle contenenti i nostri consigli.

CONFIGURA IL TUO PROFILO LED

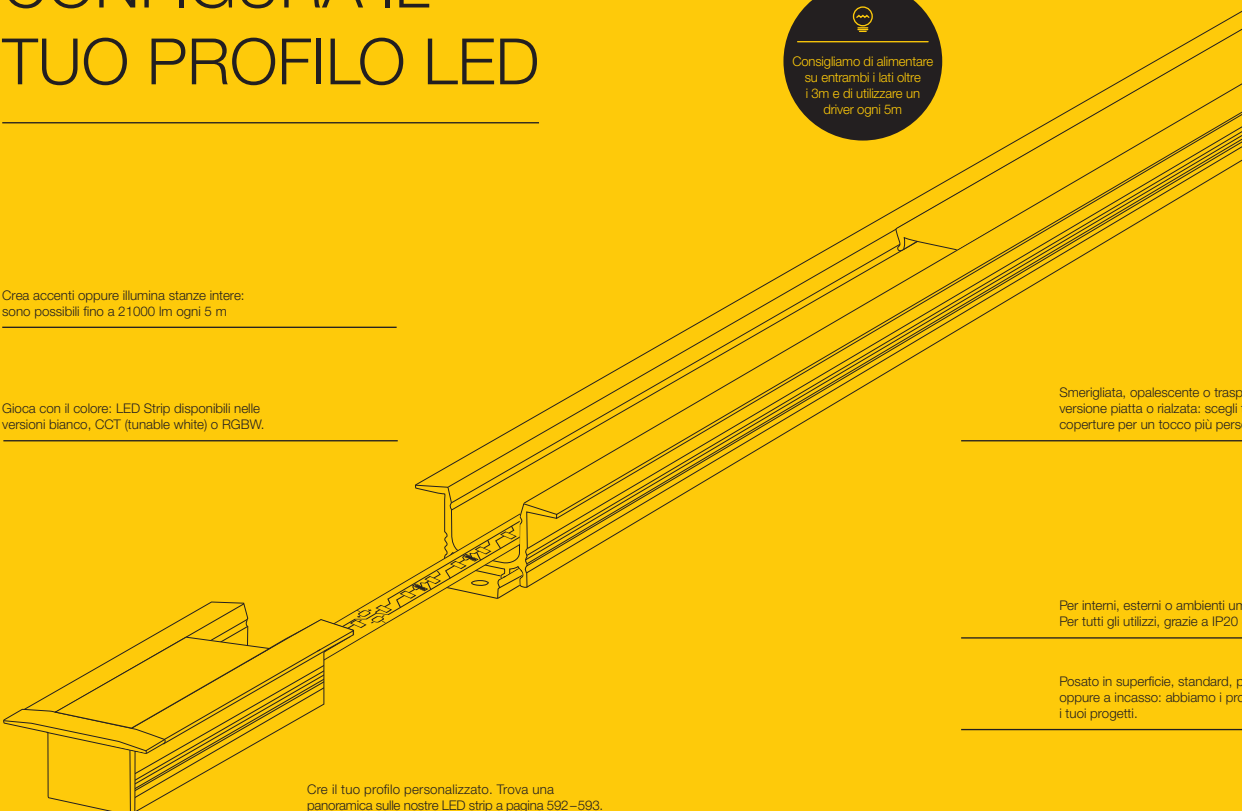

Consigliamo di alimentare su entrambi i lati oltre i 3m e di utilizzare un driver ogni 5m

Crea accenti oppure illumina stanze intere: sono possibili fino a 21000 lm ogni 5 m

Gioca con il colore: LED Strip disponibili nelle versioni bianco, CCT (tunable white) o RGBW.

Smerigliata, opalescente o trasparente. Versione piatta o rialzata: scegli tra coperture per un tocco più personalizzato.

Per interni, esterni o ambienti umidi. Per tutti gli utilizzi, grazie a IP20 e oltre.

Posato in superficie, standard, piatto oppure a incasso: abbiamo i profili per tutti i tuoi progetti.

Crea il tuo profilo personalizzato. Trova una panoramica sulle nostre LED strip a pagina 592-593. I driver adatti sono disponibili nella sezione dedicata agli accessori alle pagine 866-881.

Grazie alla tecnologia a 24V potrai realizzare lunghi tratti con minori punti di accensione.

580



TUTTI I PRODOTTI DIRETTAMENTE ONLINE

Su slv.com troverai l'intera gamma SLV con tutti i dati dei prodotti, le descrizioni, le disponibilità e molto altro. Utili file per la progettazione, dati 3D, configuratori e strumenti di calcolo come FastCalc by DIAL ti assisteranno nei tuoi progetti illuminotecnici.

VILLA WALDFEUCHT

UNA CASA PIENA DI PRODOTTI SLV

Una pagina Instagram che racconta l'avventura della costruzione della casa di una giovane coppia.

Il motivo per cui i due hanno scelto gli apparecchi di SLV e quali ostacoli hanno dovuto superare vengono riportati quotidianamente sul loro canale.



UN'ATTENTA PROGETTAZIONE ILLUMINOTECNICA

Per i due clienti, nella progettazione dell'illuminazione era importante creare uno stile uniforme in tutta la casa. Inoltre, l'illuminazione doveva potersi adattare a utilizzi successivi diversi, ovvero garantire la massima flessibilità.

Negli apparecchi dovevano essere previste sorgenti luminose smart. Susanna e Marc desideravano, tra l'altro, una combinazione di illuminazione diretta e indiretta che mettesse in luce anche le opere d'arte. Per tutti questi motivi hanno scelto i binari SLV. Quasi nessun altro tipo di illuminazione offre maggiore flessibilità: tutti gli apparecchi possono essere posizionati, aggiunti o orientati in modo diverso.

Anche in termini di efficienza energetica i binari sono incredibili: con l'illuminazione indiretta e il controllo intelligente è possibile risparmiare energia.



Susanna e Marc Mevißen condividono con i loro follower tutti i progressi a partire dalla cerimonia di prima posa nel 2020, fino al completamento avvenuto quest'anno.

Va comunque sottolineato che i due, a parte la costruzione grezza, hanno realizzato tutto da soli. Nonostante gli interventi della casa siano stati effettuati alla fine della loro giornata lavorativa, hanno prestato particolare attenzione all'edilizia sostenibile, all'efficienza energetica e al design raffinato. Il risultato: dopo soli 22 mesi la casa era già pronta per essere abitata.

*„ABBIAMO SCELTO SLV FIN DALL'INIZIO
E QUESTO CI HA SEMPLIFICATO MOLTO
LA PROGETTAZIONE ILLUMINOTECNICA.“*

Marc Mevißen, architetto

SERVIZIO E QUALITÀ SLV

C'è un motivo per cui Susanna e Marc hanno scelto gli apparecchi SLV: Marc Mevißen aveva già conosciuto SLV durante i suoi studi di architettura, quando si occupava degli allestimenti con luci e ombre nello showroom.

Nel progettare l'illuminazione della casa dei loro sogni, i due influencer sono rimasti particolarmente colpiti dal design e dall'interessante rapporto qualità-prezzo dei binari. A questo si sono aggiunti il buon supporto e il servizio rapido di SLV.





LA LUCE COME OPERA D'ARTE

La sala da pranzo della casa di Susanna e Marc è un ampio vano alto 5,65 m. Sopra il tavolo da pranzo, i due hanno voluto creare una sorta di scultura con gli apparecchi di illuminazione. Come struttura di base, i binari sono stati integrati in maniera invisibile nel controsoffitto acustico per rimanere flessibili il più possibile. Il team SLV ha collaborato sul posto con i proprietari dell'immobile per trovare ispirazione. „La PANTILO ci è piaciuta molto in termini di design e colore per riempire esteticamente lo spazio aereo senza abbagliare“, racconta Susanna Mevißen. „Amiamo questo riflesso nelle lampade che perfeziona il nostro ambiente.“

La sospensione PANTILO colpisce per l'estetica inconsueta: il diffusore in vetro cromato è può essere combinato in un'legante composizione personalizzata. I sette apparecchi PANTILO sopra il grande tavolo da pranzo si adattano perfettamente all'alto soffitto in legno, alle pareti chiare, al pavimento grigio e agli infissi neri della casa di Susanna e Marc.

*„GLI APPARECCHI NON SONO SOLO FUNZIONALI,
MA POSSONO ANCHE DARE A UN AMBIENTE
L'IDENTITÀ DI OPERA D'ARTE.“*

Susanna Mevißen

LUCE INDIRECTA PER UN PIACEVOLE AMBIENTE ABITATIVO

La casa è dotata di illuminazione SLV non solo sui soffitti: anche nel pavimento sono integrati degli spot i cui i colori possono essere regolati a piacimento. I due committenti si affidano all'illuminazione indiretta e al controllo intelligente per tutta la casa: a seconda dell'intensità luminosa della stanza, alcuni apparecchi indiretti la sera illuminano automaticamente gli ambienti rievocando l'atmosfera desiderata. In questo modo, non è necessario accendere direttamente alcuna luce, con conseguente risparmio di energia.



EDILIZIA E ILLUMINAZIONE ECOLOGICHE

Grazie all'isolamento ben studiato, al tetto piano con impianto fotovoltaico e a materiali selezionati come calcestruzzo, legno, vetro e pietra naturale, la casa dei due influencer Susanna e Marc soddisfa la norma KfW40+ ed è un edificio passivo ad alta efficienza energetica. Con l'impianto fotovoltaico producono molta più energia di quanta ne consumino. La casa dispone anche di un accumulatore di energia e una stazione di ricarica per utilizzare l'elettricità in modo ancora più efficace.

Tale approccio è in linea anche con la nostra strategia per la sostenibilità: anche noi cerchiamo infatti di fare affidamento sull'uso di materie prime secondarie nella produzione di soluzioni illuminotecniche e di ridurre costantemente i rifiuti di imballaggio e le emissioni del trasporto.

PROGETTO FORTE. PARTNER FORTI

Committenti: Susanna e Marc Mevißen

Ubicazione: Waldfeucht, Renania Settentrionale-Vestfalia
E-mail: mevissen.haus@gmail.com

Progettazione illuminotecnica: i committenti in collaborazione con il personale SLV

L'illuminazione della villa di Waldfeucht non è la sola collaborazione che i nostri esperti hanno sostenuto attivamente.

I nostri partner sono presenti in tutta Europa, con progetti di tutte le dimensioni. Vuoi vederne altri? Scansionami!



NOZIONI SLV SULL'ILLUMINAZIONE

LUMEN

Il flusso luminoso (espresso in lumen) descrive la quantità di luce emessa da una sorgente luminosa in tutte le direzioni. È considerata la luminosità totale percepita dall'occhio umano. L'efficienza di un apparecchio è spesso indicata in lumen per watt. Più alto è il flusso luminoso emesso (in lumen) per potenza assorbita (in watt), più efficiente è una sorgente luminosa.

CRI

L'indice di resa cromatica CRI (Color Rendering Index) è l'effetto di una sorgente luminosa sull'impressione cromatica che un individuo ha di un oggetto rispetto a una sorgente di luce naturale (ad esempio, la luce del sole). Secondo la norma EN 12464-1, gli ambienti interni in cui si trascorre molto tempo o si lavora dovrebbero avere un indice di resa cromatica (CRI) >80.

TEMPERATURA DEL COLORE

La temperatura del colore di una sorgente luminosa è espressa in gradi Kelvin (K). Maggiore è la temperatura del colore, più la luce risulta fredda e con effetto attivante (ad esempio: luce diurna = 5500K). Più basso è il numero di Kelvin, più calda e rilassante è la luce. La temperatura del colore di 2700K della vecchia lampadina a filamento è percepita ancora oggi come la luce perfetta per la casa. La temperatura del colore di un apparecchio può essere regolata tramite la funzione aggiuntiva dell'interruttore CCT.

DIM-TO-WARM (DTW)

Con la funzione dim-to-warm è possibile regolare la temperatura del colore e l'intensità luminosa degli apparecchi. In questo modo, la luce passa da luminosa e fredda a morbida e calda quando viene attenuata.

TUNEABLE WHITE (TW)

La funzione Tuneable White consente di regolare a piacimento la temperatura del colore degli apparecchi a LED. Questo permette di adattare la luce ai diversi momenti della giornata e all'ambiente.

RGB RGB+W

Un apparecchio RGB può coprire l'intero spettro cromatico dei colori rosso, verde e blu, mentre il valore del bianco passa in secondo piano. Con l'aggiunta di RGB+W, il valore del bianco è ulteriormente ottimizzato e di alta qualità.

CLASSE DI ISOLAMENTO

Le classi di isolamento indicano le misure di sicurezza di un dispositivo per prevenire le scariche elettriche. Esistono tre classi di isolamento (Classe I: isolamento principale con collegamento della massa; Classe II: doppio isolamento senza collegamento della massa; Classe III: isolamento ridotto per sistemi a bassissima tensione di sicurezza SELV) ciascuna rappresentata dai simboli sottostanti.



APERTURA DEL FASCIO LUMINOSO

L'apertura del fascio luminoso indica l'emissione luminosa in considerazione della struttura dell'apparecchio, della sorgente luminosa e della distanza da un oggetto. Quanto più piccola è l'apertura del fascio luminoso, tanto più stretto e concentrato è il raggio della luce.

IK

La classe di protezione IK è una classificazione dei materiali e delle superfici che determina la loro resistenza agli effetti meccanici come impatti, urti o pressioni.

IP

La sigla IP è l'acronimo di Ingress Protection (protezione contro le intrusioni). Il codice IP standardizzato indica con la prima cifra indica il grado di protezione contro la penetrazione di corpi solidi estranei, mentre la seconda descrive la tenuta ai liquidi.

UGR

UGR (Unified Glare Rating) valuta l'abbagliamento causato dagli apparecchi per evitare l'affaticamento dell'occhio. Più basso è il valore UGR, più piacevole è la luce per l'occhio. Pertanto, per i luoghi di lavoro si raccomanda un $UGR < 19$.

SMART LIGHTING

Smart Lighting è l'espressione utilizzata per descrivere la gestione e il controllo intelligente dell'illuminazione. Tramite DALI, ZIGBEE, Casambi e BLUETOOTH, gli apparecchi dotati di queste tecnologie possono essere gestiti tramite App e altri sistemi di comando.

LALU®
1007519+1007522

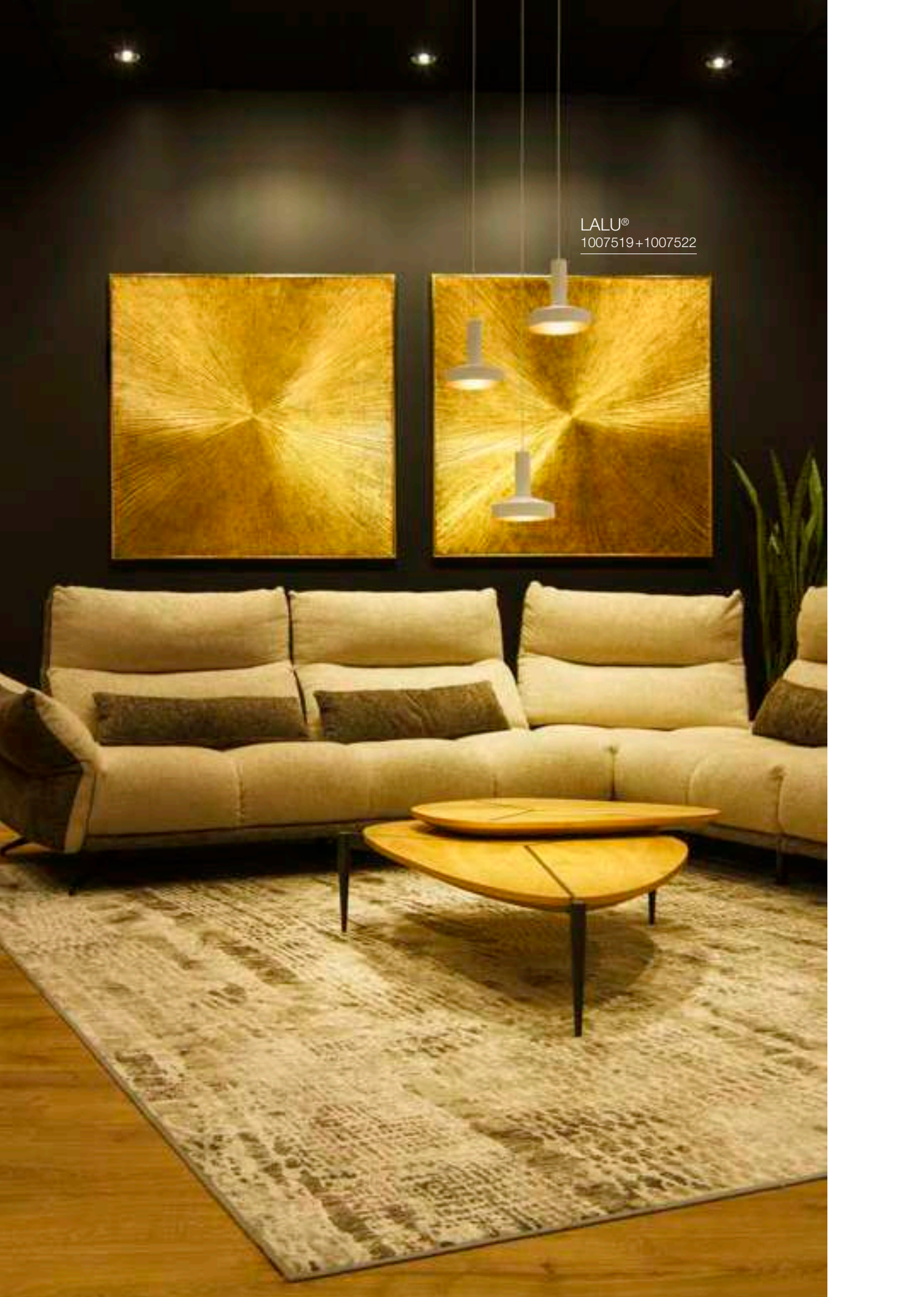

LALU®
1007520+1007532





NUMINOS®
alle pagine
82-93

LED



NEW TRIA®
alle pagine
122-147

LED



MEDO®
alle pagine
168-171

LED



NEW

LED

UNIVERSAL
DOWNLIGHT | 205



NEW

LED

UNIVERSAL
DOWNLIGHT | 207



NEW

LED

UNIVERSAL
DOWNLIGHT | 208



NEW

LED

UNIVERSAL
DOWNLIGHT | 209



NEW

LED

KADUX | 213



NEW

LED

KADUX | 213



NEW

LED

KADUX | 213



SCKET

KADUX | 214



SCKET

KADUX | 214



SCKET

KADUX | 214



SCKET

KADUX | 215



SCKET

KADUX | 215



LED

MILANDOS 4 | 217



LED

MILANDOS 6 | 217



LED

MILANDOS 8 | 217



LED

HORN MINI | 218



SCKET

HORN | 219



SCKET

HORN | 219



SCKET

HORN | 219



SCKET

HORN | 220



SCKET

HORN | 220



SCKET

HORN | 220



SCKET

HORN-T | 221



LED

HORN MAGNA | 221



LED

SENSE 12 | 223



LED

SENSE 18 | 223



LED

SENSE 24 | 223



LED

SENSE 12 | 225



LED

SENSE 18 | 225



LED

SENSE 24 | 225



LED

VERLUX | 227



LED

VERLUX | 227



LED

DL 126 | 227



SCKET

PIKA | 228



SCKET

PIKA | 228



LED

OCULUS | 229



LED
OCCULDAS 14 | 230



LED
OCCULDAS 23 | 230



LED
CONTONE® | 231



LED
CONTONE® | 231



LED
H-LIGHT | 232



LED
KARPO 30 | 232



SCKET
PLASTRA | 233



SCKET
PLASTRA | 233



LED
DEKLED | 234



SCKET
VARU | 234



SCKET
DOLIX OUT | 235



SCKET
DOLIX OUT | 235



LED
KAMUELA ECO | 236



LED
KAMUELA ECO | 237



LED
KINI | 237



LED
AKALO D83 | 237



LED
FRAME BASIC SET | 238



LED
FRAME BASIC | 238



LED
FRAME BASIC | 238



LED
FRAME CURVE | 239



LED
FRAME CURVE | 239



LED
QUAD FRAME 9 | 240



LED
NOTAPO S | 241



LED
NOTAPO L | 241



LED
DOWNUNDER PUR 80 | 242



LED
DOWNUNDER PUR 150 | 242



LED
MOBALA | 243



LED
WORO | 243



LED
LED PANEL | 243



LED
PATTA-I | 244



LED
PATTA-I | 244



LED
PATTA-I | 245



LED
PATTA-I | 245



LED
PATTA-F | 246



LED
PATTA-F | 247

INCASSI DA PARETE PER ESTERNI



ILLUMINAZIONE DA INCASSO A TERRA PER ESTERNI

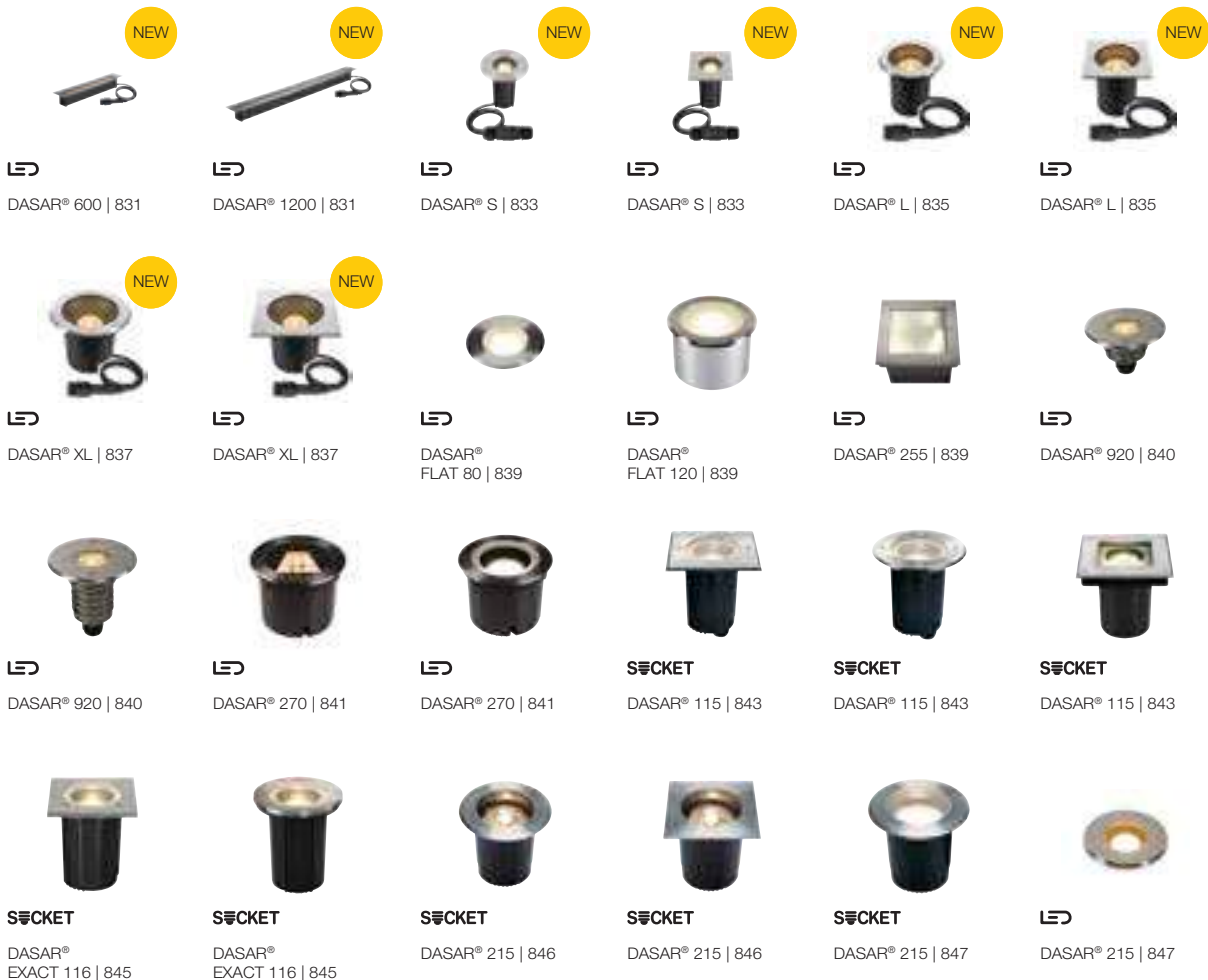



LED
TRAIL-LITE® 60 | 848



LED
POWER
TRAIL-LITE® | 849



LED
POWER
TRAIL-LITE® | 849



LED
GIMBLE OUT | 849



LED
SMALL PLOT | 851



LED
SMALL PLOT | 851



SMALL PLOT | 851



SMALL PLOT | 851



LED
BIG PLOT | 853



LED
BIG PLOT | 853



BIG PLOT | 853



BIG PLOT | 853



LED
ROCCI | 854



LED
ROCCI | 854



LED
ROCCI 200 | 855



LED
ROCCI 200 | 855



SCKET
SOLASTO | 857



SCKET
SOLASTO | 857

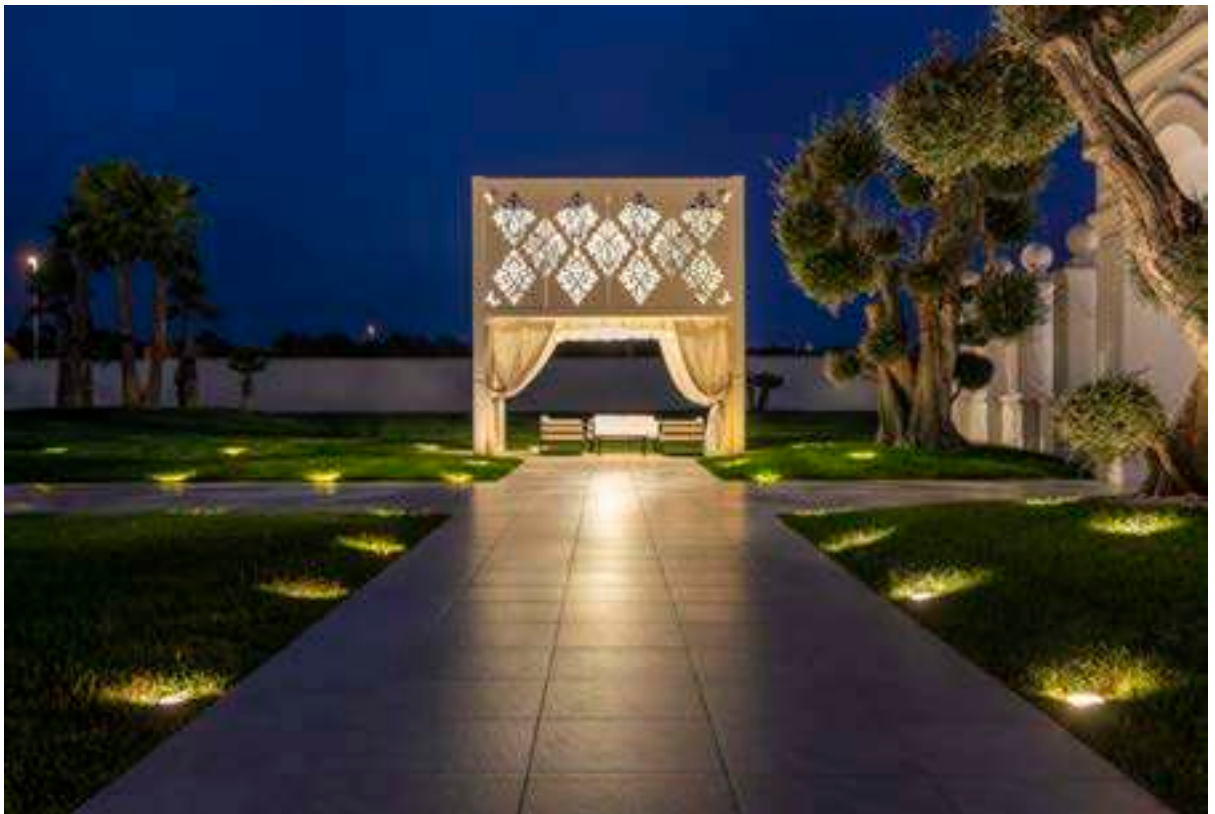



NUMINOS®
alle pagine
102-105

LED



MEDO®
alle pagine
164-165

LED



SCKET
VARYT | 251



LED
Q-LINE® | 253



LED
Q-LINE® | 253



SCKET
TRILEDO | 255



SCKET
TRILEDO | 255



SCKET
TRILEDO | 255



LED
TRILEDO | 257



LED
TRILEDO | 257



LED
TRILEDO | 257



LED
OCULUS | 258



SCKET
ENOLA B | 259



LED
ENOLA C | 259



SCKET
ASTINA | 261



SCKET
NAGY 75 | 261



LED
ANELA | 261



LED
OCCULDAS 13 | 262



LED
OCCULDAS 23 | 262



SCKET
ALTRA DICE | 263



SCKET
ALTRA DICE | 263



SCKET
KARDAMOD | 265



SCKET
KARDAMOD | 265



SCKET
FENDA | 266



LED
FENDA | 267



LED
FENDA | 267



LED
FENDA | 267



SCKET
TENORA | 268



SCKET
SOPRANA | 269



SCKET
PLASTRA | 270



LED
PLASTRA | 271



SCKET
PLASTRA 105 | 271



SCKET
PLASTRA 104 | 271



LED
FERA 25 | 272



LED
FERA 25 | 272



LED
MARONA | 273



LED
PANEL 60 | 274



LED
PANEL | 275



LED
PANEL 60 | 275



LED
PANEL | 275



LAMPADE A PLAFONE PER ESTERNI

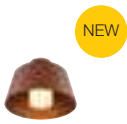

SCKET
PHOTONI | 789



LED
S-CUBE | 791



LED
ESKINA FRAME | 791



LED
ENOLA
OCULUS | 792



LED
ENOLA
ROUND S | 793



LED
ENOLA
ROUND M | 793



LED
ENOLA
ROUND L | 793



LED
ENOLA
SQUARE S | 795



LED
ENOLA
SQUARE M | 795



LED
ENOLA
SQUARE L | 795



LED
BIG THEO | 797



SCKET
BIG THEO | 797



LED
OVALISK | 797



SCKET
PHOTONIA | 799



SCKET
MOLAT | 799



SCKET
SITRA | 801



SCKET
ROX | 801



SCKET
ROX | 801





SCKET
PANTILO
ROPE 19 | 279



SCKET
PANTILO
ROPE 20 | 279



SCKET
PANTILO
ROPE 27 | 279



SCKET
PANTILO OVAL | 281



SCKET
PANTILO 20 | 281



SCKET
PANTILO 28 | 281



SCKET
PANTILO
CONVEX 29 | 283



SCKET
PANTILO
CONVEX 40 | 283



SCKET
ASTO TUBE | 285



SCKET
ASTO TUBE | 285



SCKET
ASTO TUBE | 285



SCKET
ASTO TUBE | 285



LED
WORKLIGHT
PRO 120 | 287



LED
WORKLIGHT
PRO 150 | 287



LED
WORKLIGHT | 288



LED
I-PENDANT PRO | 289



LED
PANEL 60 | 289



LED
NOYA | 290



LED
GLENOS® | 291



LED
GLENOS® | 291



LED
Q-LINE® | 293



LED
Q-LINE® | 293



LED
Q-LINE® | 293



LED
OCULUS | 294



SCKET
FITU | 295



SCKET
FENDA | 296



FENDA | 296



FENDA | 296



FENDA | 297



FENDA | 297



FENDA | 297



LED
HELIA
AMBIENT 35 | 300



LED
HELIA
AMBIENT 35 | 300



LED
HELIA 30 | 301



LED
HELIA 30 | 301



LED
HELIA 40 | 303



LED
HELIA 40 | 303



SCKET
ASTINA | 305



SCKET
ENOLA B | 305



SCKET
ENOLA | 305



LED
ANELA | 306



SCKET
LISENNE | 306



SCKET
TONGA® | 307



SCKET
QUADRASS | 307



SCKET
PARA CONE GL | 309



SCKET
PARA CONE 20 | 309



SCKET
PARA CONE 30 | 309



SCKET
PHELIA 10 | 310



SCKET
PHELIA 20 | 311



SCKET
PHELIA 25 | 311



SCKET
PHELIA 30 | 311



SCKET
FORCHINI 50 | 312



SCKET
FORCHINI 70 | 312



SCKET
FORCHINI M 40 | 313



SCKET
FORCHINI M 50 | 313



SCKET
LIGHT EYE® 90 | 314



SCKET
LIGHT EYE® 150 | 314



SCKET
SUN / BIG SUN | 315



SCKET
ROTOBALL 25 | 317



SCKET
ROTOBALL 40 | 317



SCKET
ROTOBALL 50 | 317



SCKET
PARA DOME | 318



PARA DOME | 318



PARA DOME | 318



SCKET
PARA 380 | 319

LAMPADE DA PARETE PER INTERNI



NEW

LED
LYGANT | 325



NEW

LED
LYGANT | 325

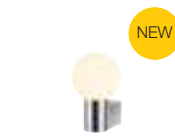

NEW

SCKET
VARYT | 327



LED
SEDO 7 | 329



LED
SEDO 14 | 329



LED
SEDO 21 | 329



LED
TRUKKO | 330



LED
TRUKKO | 330



NEW

LED
TRUKKO | 331



NEW

LED
TRUKKO 80 | 331



LED
TRUKKO 60 | 332



LED
TRUKKO 90 | 332



LED
MARYLIN 40 | 333



LED
WL 149 | 334



SCKET
WL 149 | 334



SCKET
WL 106 | 335



SCKET
WL 106 | 335



SCKET
MIBO UP/DOWN | 337



LED
MAGANDA | 337



LED
DORISA 30 | 339



LED
DORISA 50 | 339



LED
GLENOS® 60 | 339



LED
L-LINE 60 | 341



LED
L-LINE 120 | 341



LED
Q-LINE® | 341



NEW

SCKET
PANTILO ROPE | 345



NEW

SCKET
ASTO TUBE | 347



NEW

SCKET
ASTO TUBE | 347



LED
MANA BASE | 349



LED
MANA BASE | 349



LED
MANA 40 | 319



LED
MANA 60 | 349



LED
MANA | 351



LED
MANA | 351



LED
MANA | 351



LED
MANA | 353



LED
MANA | 353



LED
MANA | 353



LED
MANA | 353



NEW

LED
OCULUS | 355



LED
OCULUS
UP/DOWN | 355



SCKET
PLASTRA | 356



SCKET
PLASTRA | 356



SCKET
PLASTRA | 357



SCKET
PLASTRA | 357



SCKET
PLASTRA | 359



LED
PLASTRA | 359



LED
PLASTRA | 359



SCKET
PLASTRA | 360



SCKET
PLASTRA 101 | 361



SCKET
PLASTRA | 361



SCKET
PLASTRA 104 | 361



LED
LOGS IN | 362



LED
LOGS IN | 362



LED
LOGS IN L | 363



LED
LOGS IN L | 363



LED
QUAD FRAME 14 | 364



LED
QUAD FRAME 19 | 364



LED
SHELL 15 | 365



LED
SHELL 30 | 365



LED
ASSO 300 | 366



LED
ASSO 300 | 367



SCKET
OSSA 180 | 367



SCKET
OSSA 300 | 367



LED
CARISO | 368



LED
CARISO | 368



LED
CHROMBO | 369



LED
DIRETO 60 | 370



LED
DIRETO 90 | 370



LED
ARLINA 60 | 371



LED
ARLINA 130 | 371



SCKET
ANDREAS | 373



SCKET
DENA 30 | 373



SCKET
BASKET | 373



SCKET
QUADRASS | 375



LED
QUADRASS
SPOT | 375



SCKET
LISENNE | 375



SCKET
FITU | 376



SCKET
FITU CUBE | 376



SCKET
THEO UP/DOWN | 377



SCKET
SOLID CUBE | 377



ENOLA B | 379



ENOLA B | 379



**ASTINA
UP/DOWN** | 379

LAMPADE DA PARETE PER INTERNI



SCKET

FENDA | 380



FENDA | 380



LED

KENKUA SPOT | 381



LED

COUPA FLEX | 381



LED

KARPO MAGN | 382



LED

KARPO GOOSE | 382



LED

KARPO 30 | 383



LED

KARPO | 383



LED

SOMNILA SPOT | 384



LED

SOMNILA SPOT | 385



LED

SOMNILA FLEX | 385



LED

SOMNILA FLEX | 385



SCKET

DIO FLEX PLATE | 387



LED

DIO FLEX PLATE | 387



LED

DIO FLEX PLATE | 387



SCKET

PHELIA | 388



LED

MERADO FLOOD | 388



SCKET

DISPLAY ADL 50 | 389



LAMPADE DA PARETE PER ESTERNI



SCKET
PHOTONI | 709

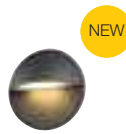

LED
LID II | 711

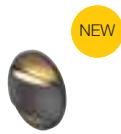

LED
LID II | 711

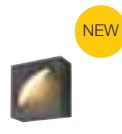

LED
LID I | 713



LED
LID I | 713



LED
I-RING | 714



LED
OVAL 14 | 715



LED
OVAL 18 | 715



LED
CONCRETO M | 717



LED
CONCRETO L | 717



LED
VANO WING | 719



LED
VANO WING | 719



LED
MANA BASE | 720



RUSTY® MANA | 720

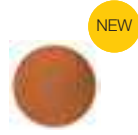

RUSTY® MANA | 720



LED
MANA OUT | 721



LED
MANA OUT | 721



LED
ENOLA OCULUS | 723



LED
ENOLA OCULUS | 723



LED
ENOLA OCULUS S | 725



LED
ENOLA OCULUS M | 725



LED
ENOLA ROUND L | 725



LED
ENOLA ROUND S UP/DOWN | 727



LED
ENOLA ROUND M UP/DOWN | 727



LED
ENOLA ROUND L UP/DOWN | 727



LED
ENOLA SQUARE S | 729



LED
ENOLA SQUARE M | 729



LED
ENOLA SQUARE L | 729



LED
ENOLA SQUARE S UP/DOWN | 730



LED
ENOLA SQUARE M UP/DOWN | 730



LED
ENOLA SQUARE L UP/DOWN | 730



SCKET
THEO UP/DOWN | 735



LED
BIG THEO BEAM UP/FLOOD DOWN | 735



SCKET
BIG THEO UP/DOWN | 735



LED
BIG THEO FLOOD UP/DOWN | 736



SCKET
THEO | 736



SCKET
BIG THEO | 737



LED
BIG THEO | 737



LED
SITRA S | 739



LED
SITRA S | 739



LED
SITRA M | 741



LED
SITRA L | 741

NEW



SCKET
SITRA CUBE | 741



SCKET
GRAFIT | 742



SCKET
GRAFIT | 742



SCKET
GRAFIT | 743



SCKET
GRAFIT | 743



LED
QUADRULO | 744



SCKET
QUADRULO
SENSOR | 745



SCKET
QUADRULO | 745



SCKET
MERIDIAN | 746



SCKET
MERIDIAN BOX | 746



SCKET
MERIDIAN BOX
SENSOR | 747



SCKET
MERIDIAN BOX | 747



LED
ESKINA FRAME | 749



LED
ESKINA FRAME | 749



LED
ESKINA FRAME | 749



LED
BOOKAT | 751



LED
BIG QUAD | 752



LED
QUAD | 752



LED
QUAD
UP/DOWN 15 | 753



LED
BIG QUAD
UP/DOWN | 755



LED
BIG QUAD | 755



LED
RUSTY®
UP/DOWN | 756



LED
RUSTY®
UP/DOWN | 756



LED
OVALISK
SENSOR | 757



LED
OVALISK | 757



LED
PEMA® | 758



LED
PEMA® | 759



LED
PEMA® | 759



SCKET
PEMA® | 759



LED
FLATT SENSOR | 760



LED
FLATT | 760



SCKET
ASTINA | 761



SCKET
ASTINA STEEL | 761



LED
ANGOLUX
SENSOR | 762



LED
ANGOLUX | 762



LED
VILUA S | 763



LED
VILUA L | 763



LED
VILUA | 763



SCKET
MYRA
UP/DOWN | 764



LED
SITRA
UP/DOWN | 765



SCKET
SITRA
UP/DOWN | 765



SCKET
ROX | 767



SCKET
ROX UP/DOWN | 767



LED
DELWA | 767



LED
SLOTS | 768



SCKET
WALLYX | 768



LED
DOWNUNDER
OUT | 769



LED
DOWNUNDER
OUT | 769



LED
ABRIDOR
SENSOR | 770



LED
ABRIDOR | 770



LED
ORDI SENSOR | 771



LED
ORDI | 771



SCKET
BOX-L | 773



LED
BOX-L | 773



SCKET
BOX UP/DOWN | 773



LED
LOGS | 775



LED
OUT-BEAM UP /
FLOOD DOWN | 775



LED
L-LINE OUT | 775



SCKET
PHOTONIA | 777



SCKET
MOLAT | 777



SCKET
GLOO PURE | 777



SCKET
F-POL | 778



SCKET
SQUARE | 779



SCKET
KERAS ELT | 779



SCKET
SITRA | 779



LED
RASCALI | 780



LED
IPERI | 780



SCKET
QUADRASYL | 781



SCKET
SQUARE TURN | 781



LED
TODAY PRO | 783



LED
ESKINA D | 783



SCKET
MYRA DISPLAY | 783



LED
LED SPOT | 785



SCKET
NAUTILUS | 785



SCKET
MYRA | 785



NUMINOS®
alle pagine
98-101

LED



MEDO®
alle pagine
148-163

LED



ONE®
alle pagine
192-193

LED



SCKET
PANTILO
ROPE 19 | 393



SCKET
PANTILO
ROPE 27 | 393



LED
CYFT | 395



SCKET
ASTO TUBE | 395



SCKET
ASTO TUBE | 397



SCKET
ASTO TUBE | 397



SCKET
ASTO TUBE | 399



SCKET
ASTO TUBE | 397



LED
OCULUS | 399



LED
KARPO 30 | 399



LED
NOBLO® | 401



LED
NOBLO® | 401



LED
NOBLO® | 401



LED
KALU | 403



LED
KALU | 403



LED
KALU | 403



LED
KALU | 403



SCKET
KALU | 405



SCKET
KALU | 405



SCKET
KALU | 405



SCKET
KALU | 405



SCKET
ENOLA B | 407



SCKET
ENOLA B | 407



SCKET
ENOLA B | 407



SCKET
ALTRA DICE | 408



SCKET
SPOT 79 | 409



SCKET
INDA | 409



SCKET
PURI | 411



SCKET
PURI | 411



SCKET
PURI | 411



SCKET
PURI | 411



SCKET
AVO | 413



SCKET
AVO | 413



SCKET
AVO | 413



SCKET
AVO | 413



SCKET
AVO | 415



SCKET
ASTO | 415



SCKET
ASTO | 415



SCKET
ASTO | 415



LED
SENSER
12, 18, 24 | 417



LED
SENSER
12, 18, 24 | 419



LED
SIMA | 420



LED
SIMA | 421



LED
LIPSY®
30, 40, 50 | 423



LED
LIPSY®
30, 40, 50 | 425-426



SCKET
MELAN | 427



SCKET
GLASSA | 427



LED
BATTEN 60 | 429



LED
BATTEN 120 | 429



LED
LONG GRILL | 430



LED
SIGHT 60 | 431



LED
SIGHT 115 | 431



LED
BENA 120 | 433



LED
BENA 150 | 433

LAMPADE DA PARETE E A PLAFONE PER ESTERNI



LED
R-CUBE | 805



LED
S-CUBE | 805



SCKET
S-TUBE | 805



LED
ESKINA SPOT/
SENSOR | 807



SCKET
SITRA 360 | 808



SCKET
THEO BRACKET | 808



LED
HELIA | 809



LED
HELIA | 809



SCKET
MYRA | 811



LED
OUT-BEAM
FRAME | 811



LED
QUADRULO | 811



LED
AINOS | 812-813



LED
AINOS | 813



LED
RUBA | 814



SCKET
BULAN | 815



SCKET
BULAN GRID | 815



LED
TERANG 200 | 817



LED
IMPERVA | 817

VINOLINA TWO
1007696





LAMPADE DA TAVOLO E DA TERRA PER INTERNI



NEW

ONE®
alle pagine
196-197



NEW

LED

VINOLINA ONE | 437



NEW

LED

VINOLINA | 437



NEW

VINOLINA TWO | 439



NEW

TAHA | 441



NEW

SCKET

TINY SUN | 443



NEW

SCKET

LITTLE SUN | 443



NEW

SCKET

VARYT | 443



NEW

LED

WORKLIGHT PRO | 444



NEW

LED

WORKLIGHT PRO | 444



LED

WORKLIGHT | 445



LED

WORKLIGHT | 445



SCKET

FENDA | 447



SCKET

FENDA | 447



SCKET

FENDA | 447



SCKET

FENDA | 448



SCKET

FENDA BOW BASIS | 448



FENDA | 448



FENDA | 449



FENDA | 449



FENDA | 449



LED

KARPO | 452



LED

KARPO | 452



SCKET

PHELIA | 453



LED

TONILA | 453



LED

MAGANDA | 453



NEW

LED
VINOLINA ONE | 597



NEW

LED
VINOLINA | 597



NEW

LED
VINOLINA TWO | 599



LED
TONILA | 601



NEW

LED
TAHA | 601



NEW

SCKET
S-TUBE 32/75 | 603



NEW

SCKET
PHOTONI 45/75 | 605



NEW

LED
S-CUBE 35/75 | 607



NEW

LED
R-CUBE 35/70 | 609



NEW

LED
LID I 75 | 611

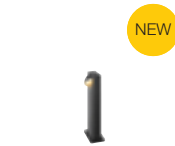

NEW

LED
LID I 45 | 611



NEW

LED
I-RING | 613



NEW

LED
M-POL S | 614



NEW

LED
M-POL S | 615



LED
M-POL S | 616



LED
M-POL S | 617



LED
M-POL S | 618



LED
M-POL M | 619



LED
M-POL M | 620



LED
M-POL M | 621



M-POL 30/60/90 | 623



SCKET
CONCRETO | 627



SCKET
CONCRETO | 627



LED
ESKINA
FRAME 45/75 | 629



LED
ESKINA
FRAME 75 | 629



LED
ESKINA FRAME
125/175 | 630



LED
ESKINA 30/80 | 631



LED
LOGS 40/70 | 633



SCKET
GRAFIT 30/60/90 | 635



SCKET
GRAFIT 30/60/90 | 637



LED
QUADRULO | 639



LED
RUSTY®
SLOT 50/80 | 640



SCKET
RUSTY®
SLOT 50/80 | 641



SCKET
RUSTY®
PATHLIGHT | 642



LED
RUSTY® 40/70 | 643



SCKET
RUSTY® 40/70 | 643



SCKET
RUSTY®
CONE 24 | 645



SCKET
RUSTY®
CONE 40/70 | 645



SCKET
RUSTY® 40/70 | 646



SCKET
ARROCK
GRANITE 40/70 | 647



SCKET
ARROCK
ARC | 648



LED
ARROCK
STONE 50/75 | 649



SCKET
ARROCK SLOT | 649



LED
L-LINE OUT 30 | 650



LED
L-LINE OUT 60 | 651



LED
L-LINE OUT 50/80 | 651



SCKET
THEO PATHLIGHT | 652



LED
OVALISK 75/100 | 653



SCKET
GLOO PURE 27/44/70 | 655



SCKET
ROTOBALL 25/40/50 | 657



SCKET
PHOTONIA | 659



SCKET
PHOTONIA | 659



SCKET
OTOS GLAS | 659



SCKET
CUBIX | 660



SCKET
CONE | 660



SCKET
MOLAT | 661



SCKET
MOLAT | 661



SCKET
LISENNE 40/70 | 662



SCKET
ADEGAN MANILA | 663



SCKET
ADEGAN | 663



SCKET
ALPA MUSHROOM 45/75 | 665



SCKET
ALPA CONE 100 | 665



LED
APONI 90/120 | 666



LED
TRUST 30/60 | 667



SCKET
BIG NAILS 50/80 | 668



SCKET
ROX ACRYL 30/60/90 | 669

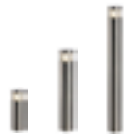

SCKET
VAP SLIM 30/60/90 | 671



SCKET
C-POL | 672



SCKET
F-POL | 672



SCKET
SQUARE POLE 30/60/90 | 673



LED
SLOTS 45/65 | 675



LED
H-POL 30/60 | 676



LED
H-POL TWIN 30/60 | 677



LED
SLOTBOX 40/70 | 678



LED
FLATT 65/100 | 679



LED
ABRIDOR 60/100 | 681



LED
IPERI 50 | 681



SCKET
QUADRASYL 75 | 682



LED
QUAD POLE | 683



LED
BOOKAT | 683



LED
RASCALI 45/65 | 684



SCKET
MYRA SPOT | 685



SCKET
SITRA 360 | 685

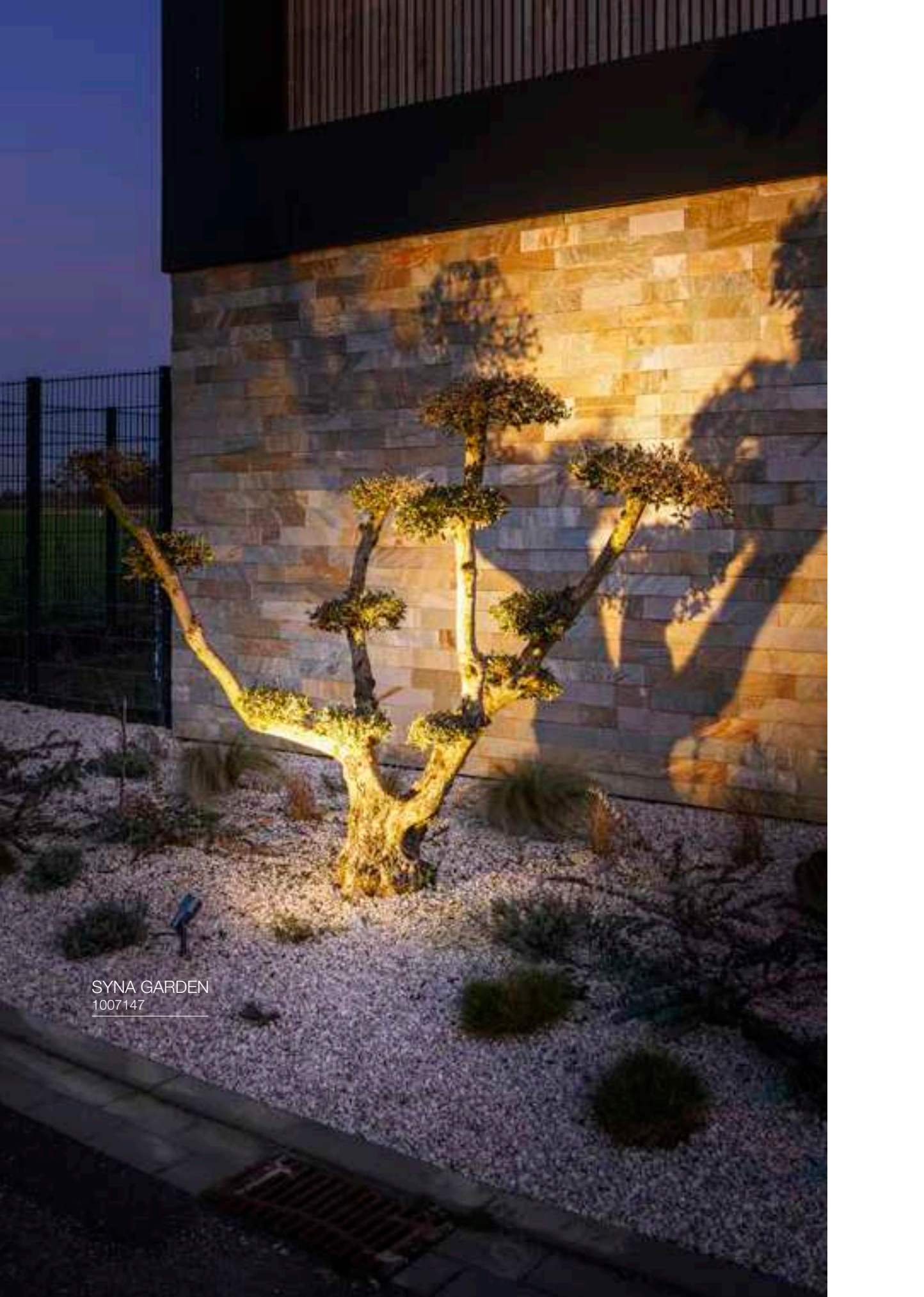

SYNA GARDEN
1007147



FARETTI PER ESTERNI



LED
SYNA PLANT | 689



LED
SYNA GARDEN | 689



LED
SYNA | 689



LED
FLOODI S | 691



LED
FLOODI M | 691



LED
FLOODI L | 691



LED
GALEN 60 | 692



LED
GALEN 120 | 692



LED
FLAC BEAM® | 693



S-CCKET
SAMRINA | 693



S-CCKET
NAUTILUS 10 | 694



S-CCKET
BIG NAUTILUS | 694



S-CCKET
NAUTILUS 10 | 695



LED
NAUTILUS 10 | 696



S-CCKET
NAUTILUS | 697



S-CCKET
NAUTILUS 10
SPOT | 697



LED
NAUTILUS 10
SPOT LED | 697



LED
DASAR®
PROJECTOR | 698



LED
DASAR® 920 | 698



LED
HELIA SPOT S | 699



LED
HELIA SPOT L | 699



S-CCKET
THEO BRACKET | 701



LED
LED SPIKE | 701



S-CCKET
SITRA 360 SPIKE | 703



S-CCKET
SITRA 360 SPIKE | 703

IN-LINE 44
1006621

NUMINOS® XS
1006762

NUMINOS® XS
1006654

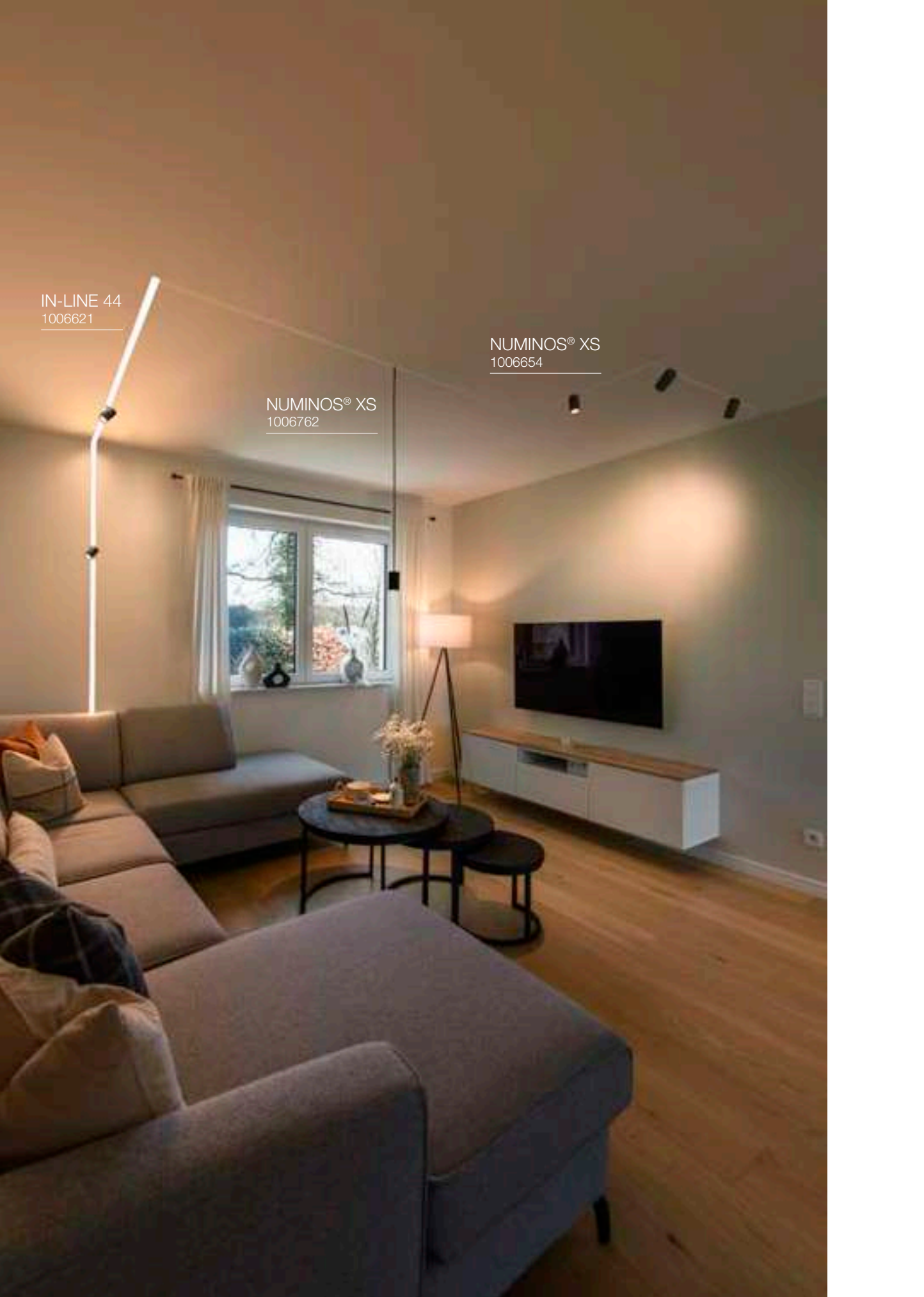



SISTEMI A 48V PER INTERNI



SISTEMI A BASSA TENSIONE PER INTERNI

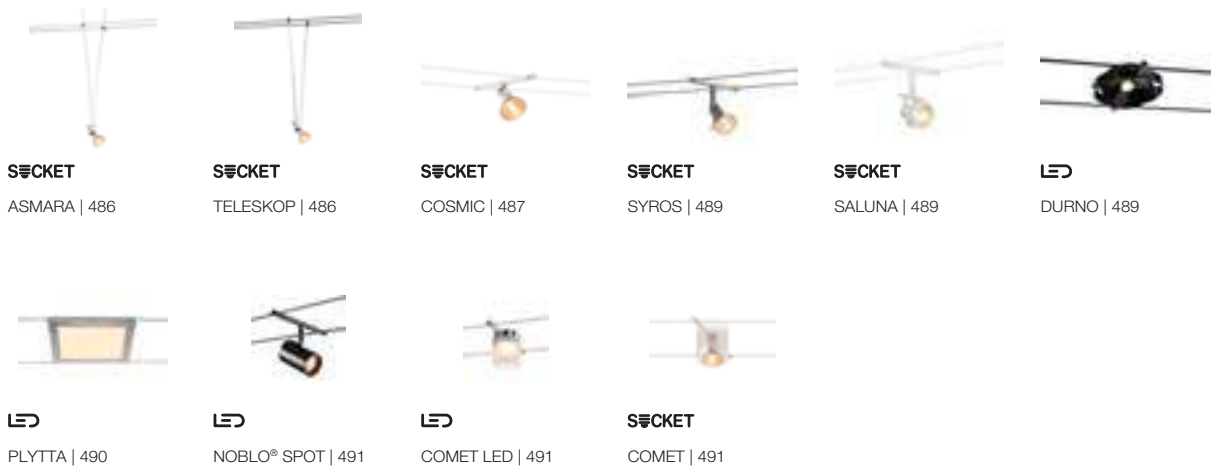

NOBLO® SPOT
1007352

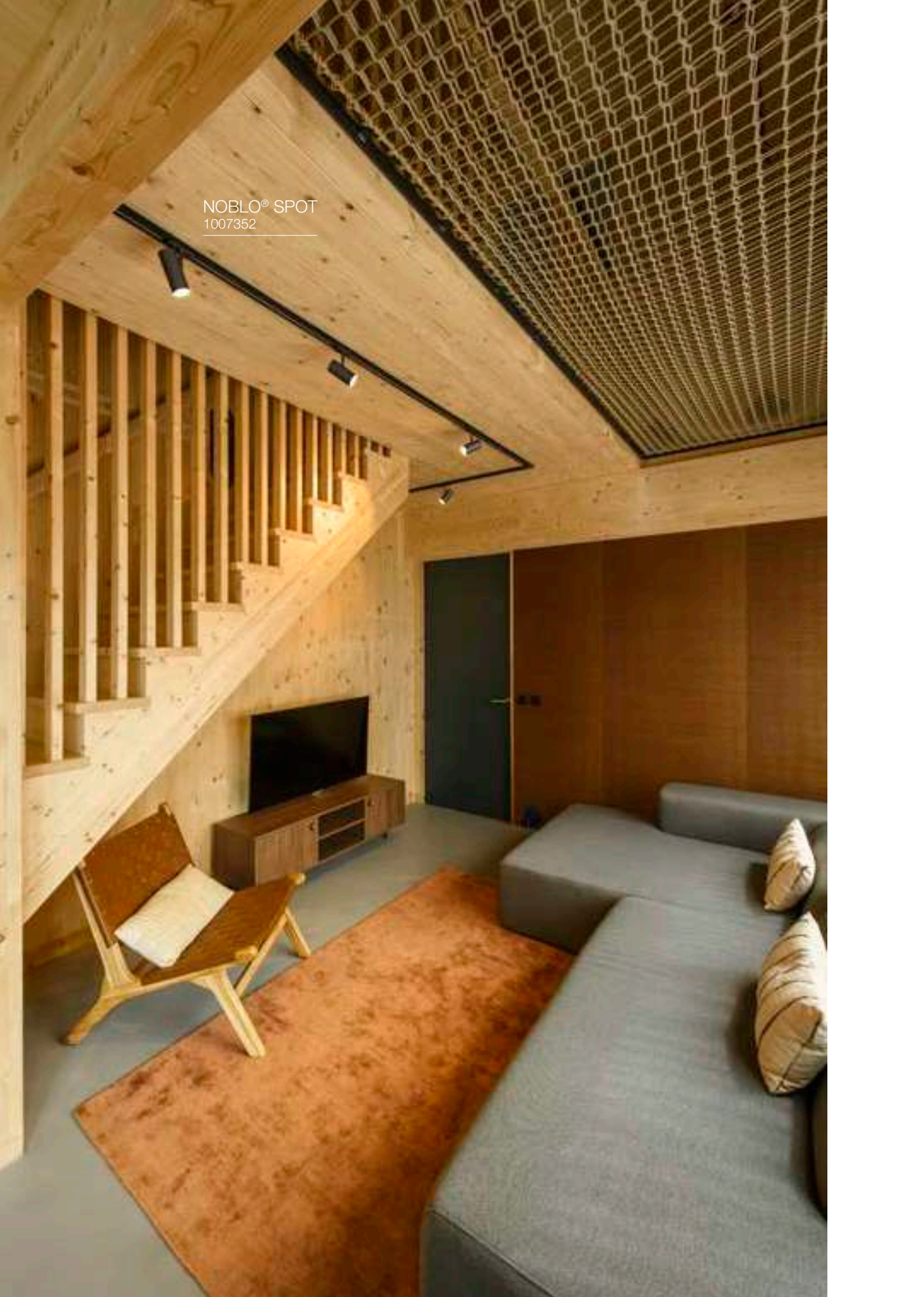



SISTEMI MONOFASE PER INTERNI



NEW

LED
NOBLO® SPOT | 501



NEW

LED
NOBLO® SPOT | 501



NEW

LED
NOBLO® SPOT | 503



NEW

LED
NOBLO® SPOT | 503



NEW

SCKET
ASTO TUBE | 505



NEW

SCKET
PANTILO
ROPE 19 | 505



LED
HELIA 50 TRACK | 507



LED
PANEL TRACK | 507



LED
PANEL TRACK | 507



SCKET
PARA CONE GL | 508



SCKET
PARA CONE GL | 508



SCKET
PARA CONE 14 | 509



SCKET
PARA CONE 14 | 509



SCKET
TONGA® | 511



SCKET
LIGHT EYE® 90 | 511



SCKET
LIGHT EYE® 150 | 511



SCKET
FORCHINI M 40
TRACK | 512



SCKET
PURI TRACK | 513



SCKET
PURI TRACK | 513



SCKET
PURI TRACK | 515



SCKET
AVO TRACK | 515



LED
ENOLA C TRACK | 516



LED
ENOLA C TRACK | 517



SCKET
ENOLA B TRACK | 517



SCKET
ENOLA B | 517



SCKET
BIMA | 519



SCKET
BIMA | 519



LED
KALU TRACK | 520



SCKET
KALU TRACK | 520



SCKET
EURO SPOT
TRACK | 521



SCKET
ALTRA DICE
TRACK | 521

TS V
1007655





SISTEMI TRIFASE PER INTERNI



TS V | 543



TS V | 543



NOBLO® SPOT | 545



NOBLO® SPOT | 545



NOBLO® SPOT | 547



NOBLO® SPOT | 547



SCKET
PANTILO
ROPE 19 | 549



SIGHT TRACK | 550



SIGHT TRACK | 550



SIGHT MOVE | 551



SIGHT MOVE | 551



PARA CONE GL | 552



PARA CONE GL | 552



PARA CONE 14 | 553



PARA CONE 14 | 553



**FORCHINI M 40
TRACK** | 554



EURO CUBE | 555



**EURO SPOT
TRACK** | 555



**EURO SPOT
TRACK** | 555



**ALTRA DICE
TRACK** | 556



PURI TRACK | 557



**PURI TRACK
GLASS** | 557



**KALU TRACK
LED** | 558



KALU TRACK | 558



BIMA | 559



BIMA | 559



HELIA 50 TRACK | 561



ENOLA C TRACK | 561



AVO TRACK | 561

GRAZIA PRO
FLEXSTRIP
1007352

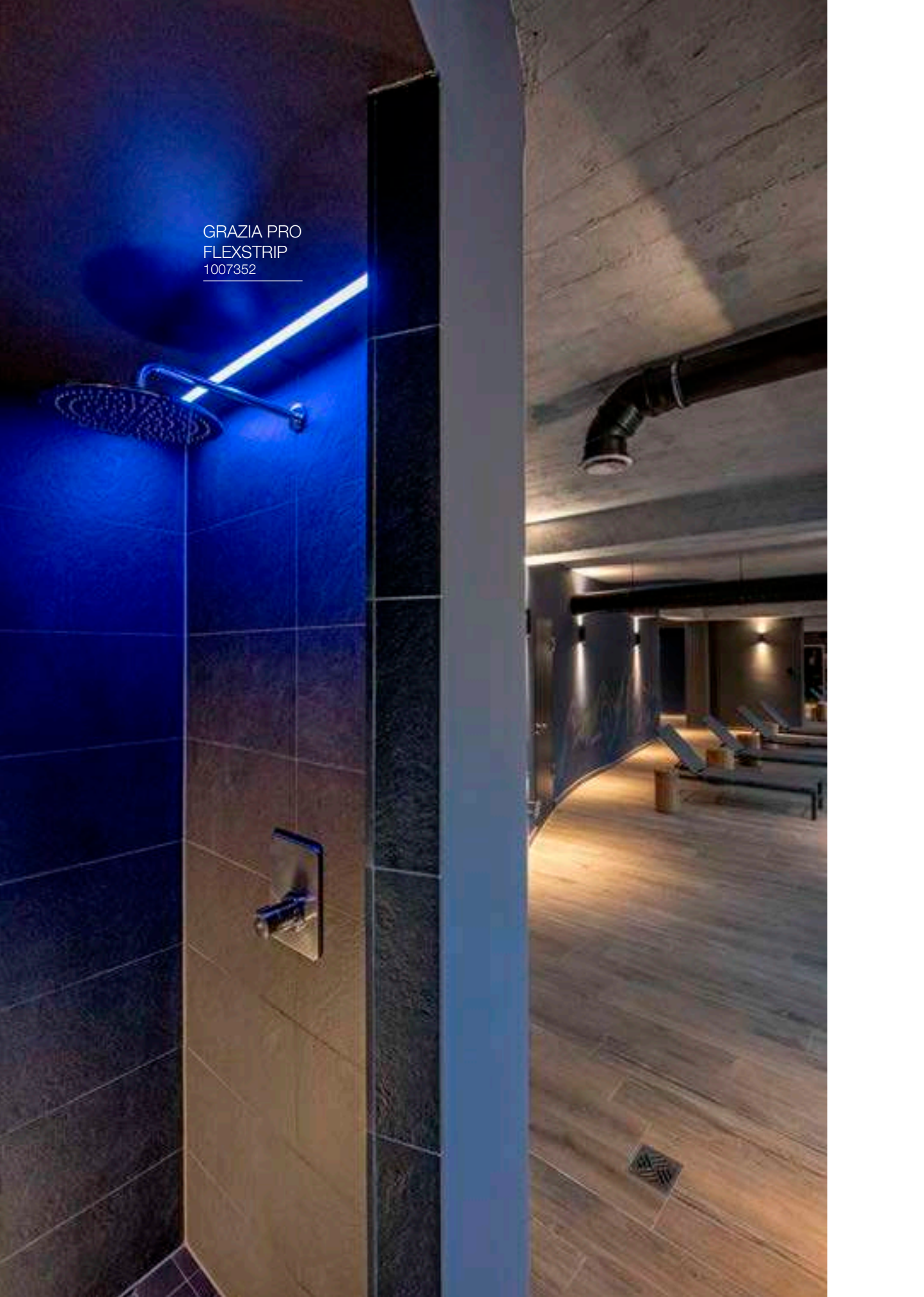

PROFILI



GRAZIA 10
PROFILO DA
SUPERFICIE | 567

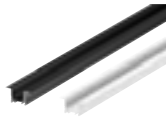

GRAZIA 10
PROFILO DA
INCASSO | 567

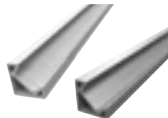

GRAZIA 10 EDGE | 570

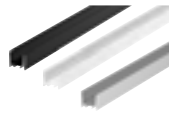

GRAZIA 20
PROFILO DA
SUPERFICIE | 573



GRAZIA 20
PROFILO DA
INCASSO | 573

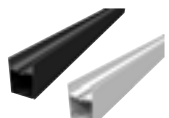

GRAZIA 60
PROFILO DA
SUPERFICIE | 577

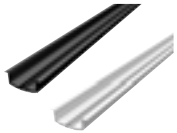

GRAZIA 60
PROFILO DA
INCASSO | 577



GRAZIA 10
ACCESSORI | 569



GRAZIA 10 EDGE
ACCESSORI | 571



GRAZIA 20
ACCESSORI |
574-575



GRAZIA 60
ACCESSORI |
578-579

LED STRIP



GRAZIA
FLEXSTRIP LED | 582



GRAZIA PRO
FLEXSTRIP LED | 583



GRAZIA PRO MAX
FLEXSTRIP | 585



GRAZIA PRO
FLEXSTRIP
TUNABLE WHITE | 587



GRAZIA PRO
FLEXSTRIP
RGBW | 589



GRAZIA IP
FLEXSTRIP | 591



GRAZIA
FLEXSTRIP LED
ACCESSORI | 582



GRAZIA PRO
FLEXSTRIP LED
ACCESSORI | 583



GRAZIA PRO MAX
FLEXSTRIP
ACCESSORI | 585



GRAZIA PRO
FLEXSTRIP
TUNABLE WHITE
ACCESSORI | 587



GRAZIA PRO
FLEXSTRIP RGBW
ACCESSORI | 589

TAHA
1007380



MEDO® PRO 90
1007309



ABRIDOR



LED
ABRIDOR 60/100 | 681



LED
ABRIDOR
SENSOR | 770



LED
ABRIDOR | 770

ADEGAN



SCKET
ADEGAN
MANILA | 663



SCKET
ADEGAN | 663

AINOS



LED
AINOS | 812-813



LED
AINOS | 813



LED
AINOS | 813

ALPA



SCKET
ALPA MUSHROOM
45/75 | 665



SCKET
ALPA CONE 100 | 665

ALTRA DICE



SCKET

ALTRA DICE | 263



SCKET

ALTRA DICE | 263



SCKET

ALTRA DICE | 408



SCKET

ALTRA DICE
TRACK | 521



SCKET

ALTRA DICE
TRACK | 556

ANELA



LED

ANELA | 261



LED

ANELA | 306

ARROCK



SCKET

ARROCK
GRANITE 40/70 | 647



SCKET

ARROCK ARC | 648



LED

ARROCK
STONE 50/75 | 649



SCKET

ARROCK SLOT | 649

ASTINA



SCKET

ASTINA | 261



SCKET

ASTINA | 305



ASTINA
UP/DOWN | 379



SCKET

ASTINA | 761



SCKET

ASTINA STEEL | 761

ASTO



SCKET

ASTO TUBE | 285



SCKET

ASTO TUBE | 285



SCKET

ASTO TUBE | 285



SCKET

ASTO TUBE | 285



NEW

SCKET

ASTO TUBE | 347



NEW

SCKET

ASTO TUBE | 347



NEW

SCKET

ASTO TUBE | 395



NEW

SCKET

ASTO TUBE | 397



NEW

SCKET

ASTO TUBE | 397

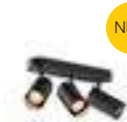

NEW

SCKET

ASTO TUBE | 399



NEW

SCKET

ASTO TUBE | 397



SCKET

ASTO | 415



SCKET

ASTO | 415



SCKET

ASTO | 415



NEW

SCKET

ASTO TUBE | 505

AVO



SCKET

AVO | 413



SCKET

AVO | 413



SCKET

AVO | 413



SCKET

AVO | 413



SCKET

AVO | 415



SCKET

AVO TRACK | 515/561

BIMA



SCKET

BIMA | 519



SCKET

BIMA | 519



SCKET

BIMA | 559



SCKET

BIMA | 559



BOOKAT



LED

BOOKAT | 751



LED

BOOKAT | 683

BOX



SOCKET

BOX-L | 773



LED

BOX-L | 773



SOCKET

BOX UP/DOWN | 773

BRICK



LED

BRICK MESH | 825



LED

BRICK | 825



LED

BRICK | 825



SOCKET

BRICK
DOWNUNDER | 827



LED

BRICK
DOWNUNDER | 827

BULAN



SOCKET

BULAN | 815



SOCKET

BULAN GRID | 815

CARISO



LED
CARISO | 368



LED
CARISO | 368

CONCRETO



SCKET
CONCRETO | 627



SCKET
CONCRETO | 627



NEW

LED
CONCRETO M | 717



NEW

LED
CONCRETO L | 717



NEW

SCKET
CONCRETO | 821



NEW

LED
CONCRETO | 821

CONTONE®



LED
CONTONE® | 231



LED
CONTONE® | 231

CUBE



NEW

LED
S-CUBE 35/75 | 607



NEW

LED
R-CUBE 35/70 | 609



NEW

LED
S-CUBE | 791



NEW

LED
R-CUBE | 805



NEW

LED
S-CUBE | 805



DASAR®



LED
DASAR® 600 | 831



LED
DASAR® 1200 | 831



LED
DASAR® S | 833



LED
DASAR® S | 833



LED
DASAR® L | 835



LED
DASAR® L | 835



LED
DASAR® XL | 837



LED
DASAR® XL | 837



LED
DASAR® FLAT 80 | 839



LED
DASAR® FLAT 120 | 839



LED
DASAR® 255 | 839



LED
DASAR® 920 | 840



LED
DASAR® 920 | 840



LED
DASAR® 270 | 841



LED
DASAR® 270 | 841



SCKET
DASAR® 115 | 843



SCKET
DASAR® 115 | 843



SCKET
DASAR® 115 | 843



SCKET
DASAR® EXACT 116 | 845



SCKET
DASAR® EXACT 116 | 845



SCKET
DASAR® 215 | 846



SCKET
DASAR® 215 | 846



SCKET
DASAR® 215 | 847



LED
DASAR® 215 | 847



LED
DASAR® PROJECTOR | 698



LED
DASAR® 920 | 698

DIO FLEX



SCKET
DIO FLEX PLATE | 387



LED
DIO FLEX PLATE | 387



LED
DIO FLEX PLATE | 387

DOLIX



SCKET

DOLIX OUT | 235



SCKET

DOLIX OUT | 235

DOWNUNDER OUT



LED

DOWNUNDER
OUT | 769



LED

DOWNUNDER
OUT | 769



LED

DOWNUNDER
OUT S | 823



LED

DOWNUNDER
OUT M | 823



LED

DOWNUNDER
OUT L | 823

ENOLA



SCKET

ENOLA B | 259



LED

ENOLA C | 259



SCKET

ENOLA B | 305



SCKET

ENOLA | 305



ENOLA B | 379



ENOLA B | 379



SCKET

ENOLA B | 407



SCKET

ENOLA B | 407



SCKET

ENOLA B | 407



LED

ENOLA C TRACK | 516



LED

ENOLA C TRACK | 517



SCKET

ENOLA B TRACK | 517



SCKET

ENOLA B | 517



LED

ENOLA C TRACK | 561



NEW

LED

ENOLA
OCULUS | 723



NEW

LED

ENOLA
OCULUS | 723



LED

ENOLA
OCULUS S | 725



LED

ENOLA
OCULUS M | 725



LED
ENOLA
ROUND L | 725



LED
ENOLA ROUND S
UP/DOWN | 727



LED
ENOLA ROUND M
UP/DOWN | 727



LED
ENOLA ROUND L
UP/DOWN | 727



LED
ENOLA
SQUARE S | 729



LED
ENOLA
SQUARE M | 729



LED
ENOLA
SQUARE L | 729



LED
ENOLA SQUARE S
UP/DOWN | 730



LED
ENOLA SQUARE M
UP/DOWN | 730



LED
ENOLA SQUARE L
UP/DOWN | 730



LED
ENOLA
OCULUS | 792



LED
ENOLA
ROUND S | 793



LED
ENOLA
ROUND M | 793



LED
ENOLA
ROUND L | 793



LED
ENOLA
SQUARE S | 795



LED
ENOLA
SQUARE M | 795



LED
ENOLA S
QUARE L | 795

ESKINA



LED
ESKINA
FRAME 45/75 | 629



LED
ESKINA
FRAME 75 | 629



LED
ESKINA FRAME
125/175 | 630



LED
ESKINA 30/80 | 631



LED
ESKINA FRAME | 749



LED
ESKINA FRAME | 749



LED
ESKINA FRAME | 749



LED
ESKINA D | 783



LED
ESKINA FRAME | 791



LED
ESKINA SPOT
SENSOR | 807



LED
ESKINA SPOT | 807

EURO SPOT



SCKET

EURO SPOT
TRACK | 521



SCKET

EURO SPOT
TRACK | 555



SCKET

EURO SPOT
TRACK | 555

FENDA



SCKET

FENDA | 266



SCKET

FENDA | 296



SCKET

FENDA | 447



SCKET

FENDA | 447



SCKET

FENDA | 447



SCKET

FENDA | 448



SCKET

FENDA BOW
BASIS | 448



SCKET

FENDA | 380



FENDA | 380



FENDA | 296



FENDA | 296, 448



FENDA | 267, 297, 449



FENDA | 267, 297, 449



FENDA | 267, 297, 449

FITU



SCKET

FITU | 295



SCKET

FITU | 376



SCKET

FITU CUBE | 376



FLATT



LED

FLATT 65/100 | 679



LED

FLATT SENSOR | 760



LED

FLATT | 760

FORCHINI



SCKET

FORCHINI 50 | 312



SCKET

FORCHINI 70 | 312



SCKET

FORCHINI M 40 | 313



SCKET

FORCHINI M 50 | 313



SCKET

FORCHINI M 40
TRACK | 512



SCKET

FORCHINI M 40
TRACK | 554

F-POL



SCKET

F-POL | 672



SCKET

F-POL | 778

GLENOS®



LED

GLENOS® | 291



LED

GLENOS® | 291



LED

GLENOS® 60 | 339

GLOO PURE



SCKET

GLOO PURE
27/44/70 | 655



SCKET

GLOO PURE | 777

GRAFIT



SCKET

GRAFIT 30/60/90 | 635



SCKET

GRAFIT 30/60/90 | 637



SCKET

GRAFIT | 742



SCKET

GRAFIT | 742



SCKET

GRAFIT | 743



SCKET

GRAFIT | 743

HELIA



LED

HELIA
AMBIENT 35 | 300



LED

HELIA
AMBIENT 35 | 300



LED

HELIA 30 | 301



LED

HELIA 30 | 301



LED

HELIA 40 | 303



LED

HELIA 40 | 303



LED

HELIA 50 TRACK | 507



LED

HELIA 50 TRACK | 561



LED

HELIA SPOT S | 699



LED

HELIA SPOT L | 699



LED

HELIA | 809



LED

HELIA | 809



HORN



LED
HORN MINI | 218



SCKET
HORN | 219



SCKET
HORN | 219



SCKET
HORN | 219



SCKET
HORN | 220



SCKET
HORN | 220



SCKET
HORN | 220



SCKET
HORN-T | 221



LED
HORN MAGNA | 221

H-POL



LED
H-POL 30/60 | 676



LED
H-POL TWIN
30/60 | 677

IPERI



LED
IPERI 50 | 681



LED
IPERI | 780

I-RING



LED
I-RING | 613



LED
I-RING | 714

KADUX



LED
KADUX | 213



LED
KADUX | 213



LED
KADUX | 213



SCKET
KADUX | 214



SCKET
KADUX | 214



SCKET
KADUX | 214



SCKET
KADUX | 215



SCKET
KADUX | 215

KALU



LED
KALU | 403



LED
KALU | 403



LED
KALU | 403



LED
KALU | 403



SCKET
KALU | 405



SCKET
KALU | 405



SCKET
KALU | 405



SCKET
KALU | 405



LED
KALU TRACK | 520



SCKET
KALU TRACK | 520



LED
KALU TRACK LED | 558



SCKET
KALU TRACK | 558



KARDAMOD



SCKET

KARDAMOD | 265



SCKET

KARDAMOD | 265

KARPO



LED

KARPO 30 | 232



LED

KARPO MAGN | 382



LED

KARPO GOOSE | 382



LED

KARPO 30 | 383



LED

KARPO | 383



LED

KARPO 30 | 399



LED

KARPO | 452



LED

KARPO | 452

LALU®



NEW

LED

LALU® | 177



NEW

LED

LALU® | 177



NEW

LALU® TETRA 14 | 178



NEW

LALU® TETRA 24 | 178



NEW

LALU® TETRA 36 | 178



NEW

LALU® CONE 15 | 178



NEW

LALU® ELYPSE 15 | 178



NEW

LALU® ELYPSE 22 | 178



NEW

LALU® ELYPSE 33 | 178



NEW

LALU® PLATE 15 | 178



NEW

LALU® PLATE 22 | 178



NEW

SCKET

LALU® | 183

LID



LED
LID I 75 | 611

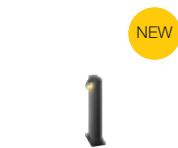

LED
LID I 45 | 611

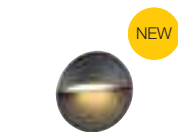

LED
LID II | 711

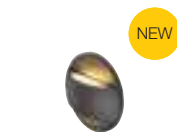

LED
LID II | 711

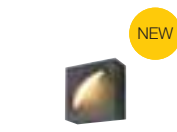

LED
LID I | 713



LED
LID I | 713

LIGHT EYE



SCKET
LIGHT EYE® 90 | 314



SCKET
LIGHT EYE® 150 | 314



SCKET
LIGHT EYE® 90 | 511



SCKET
LIGHT EYE® 150 | 511

LIPSY



LED
LIPSY® 30 | 423



LED
LIPSY® 40 | 423



LED
LIPSY® 50 | 423



LED
LIPSY® 30 | 425



LED
LIPSY® 40 | 425



LED
LIPSY® 50 | 425



LED
LIPSY® 40 | 426



LED
LIPSY® 50 | 426



LISENNE



SOCKET
LISENNE | 306



SOCKET
LISENNE | 375



SOCKET
LISENNE 40/70 | 662

L-LINE



LED
L-LINE 60 | 341



LED
L-LINE 120 | 341



LED
L-LINE OUT 30 | 650



LED
L-LINE OUT 60 | 651



LED
L-LINE
OUT 50/80 | 651



LED
L-LINE OUT | 775

LOGS



LED
LOGS IN | 362



LED
LOGS IN | 362



LED
LOGS IN L | 363



LED
LOGS IN L | 363



LED
LOGS 40/70 | 633



LED
LOGS | 775

MAGANDA



LED
MAGANDA | 337



LED
MAGANDA | 453

MEDO® PRO 40
1006414 (DC)





MANA



LED
MANA
BASE | 349, 720



MANA BASE | 349



MANA 40 | 319



MANA 60 | 349



LED
MANA | 351



MANA | 351



MANA | 351



LED
MANA | 353



LED
MANA | 353



MANA | 353



MANA | 353



RUSTY® MANA | 720



RUSTY® MANA | 720



LED
MANA OUT | 721



LED
MANA OUT | 721

MEDO



LED
MEDO® PRO
30 | 150, 152, 157



LED
MEDO® PRO
40 | 150, 152, 157



LED
MEDO® PRO
60 | 151, 153, 157



LED
MEDO® PRO
90 | 151, 153, 157



LED
MEDO® 30 | 161



LED
MEDO® 40 | 161



LED
MEDO® 60 | 161



LED
MEDO® 90 | 161



LED
MEDO® 60 | 165



LED
MEDO® RING 60 | 167



LED
MEDO® RING 90 | 167



LED
MEDO® 30 | 170



LED
MEDO® 40 | 170



LED
MEDO® 60 | 170



LED
MEDO® 30 | 171



LED
MEDO® 40 | 171



LED
MEDO® 60 | 171

MERIDIAN



SCKET

MERIDIAN | 746



SCKET

MERIDIAN BOX | 746



SCKET

MERIDIAN BOX
SENSOR | 747



SCKET

MERIDIAN BOX | 747

MOLAT



SCKET

MOLAT | 661



SCKET

MOLAT | 661



SCKET

MOLAT | 777



SCKET

MOLAT | 799

M-POL



LED

M-POL S | 614



LED

M-POL S | 615



LED

M-POL S | 616



LED

M-POL S | 617



LED

M-POL S | 618



LED

M-POL M | 619



LED

M-POL M | 620



LED

M-POL M | 621



M-POL 30/60/90 | 623



MYRA



SCKET

MYRA SPOT | 685



SCKET

MYRA
UP/DOWN | 764



SCKET

MYRA | 811

NAUTILUS



SCKET

NAUTILUS 10 | 694



SCKET

BIG NAUTILUS | 694



SCKET

NAUTILUS 10 | 695



LED

NAUTILUS 10 | 696



SCKET

NAUTILUS | 697



SCKET

NAUTILUS 10
SPOT | 697



LED

NAUTILUS 10
SPOT LED | 697



SCKET

NAUTILUS | 785

NEW TRIA®

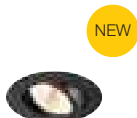

LED

NEW TRIA®
68 | 134, 135

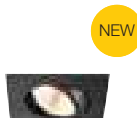

LED

NEW TRIA®
68 | 134, 135

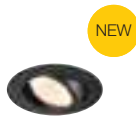

LED

NEW TRIA® UNIVERSAL
68 | 136, 137

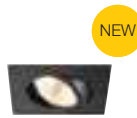

LED

NEW TRIA® UNIVERSAL
68 | 136, 137



LED

NEW TRIA® 75 | 137

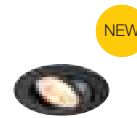

LED

NEW TRIA® 68 | 138

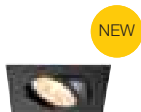

LED

NEW TRIA® 68 | 138

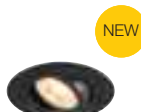

LED

NEW TRIA® 75 | 138



LED

NEW TRIA® 75 | 138



LED

NEW TRIA® 75 XL | 139

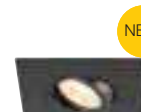

LED

NEW TRIA® 75 XL | 139

NEW TRIA®



LED
NEW TRIA® 45 | 141



LED
NEW TRIA® 155 | 141



LED
NEW TRIA® 150 | 145



LED
NEW TRIA® 150 | 145



LED
NEW TRIA® 155 | 145



LED
NEW TRIA® 300 | 145

NOBLO®



LED
NOBLO® | 401



LED
NOBLO® | 401



LED
NOBLO® | 401



LED
NOBLO® SPOT | 491



LED
NOBLO® SPOT | 501



LED
NOBLO® SPOT | 501



LED
NOBLO® SPOT | 503



LED
NOBLO® SPOT | 503



LED
NOBLO® SPOT | 545



LED
NOBLO® SPOT | 545



LED
NOBLO® SPOT | 547



LED
NOBLO® SPOT | 547

NUMINOS®



LED
NUMINOS® XS | 84



LED
NUMINOS® S | 84



LED
NUMINOS® M | 85



LED
NUMINOS® L | 85



LED
NUMINOS® XL | 85



LED
NUMINOS® MOVE
XS | 86



LED
NUMINOS® MOVE
S | 86



LED
NUMINOS® MOVE
M | 87



LED
NUMINOS® MOVE
L | 87



LED
NUMINOS® MOVE
XL | 87



NUMINOS® GIMBLE XS | 88



NUMINOS® GIMBLE S | 88



NUMINOS® GIMBLE M | 89



NUMINOS® GIMBLE L | 89



NUMINOS® GIMBLE XL | 89



NEW



NUMINOS® PROJECTOR XS | 92



NEW



NUMINOS® PROJECTOR S | 92



NEW



NUMINOS® PROJECTOR M | 93



NEW



NUMINOS® PROJECTOR XL | 93



NUMINOS® S | 100



NUMINOS® M | 100



NUMINOS® L | 101



NUMINOS® XL | 101



NUMINOS® S | 104



NUMINOS® M | 104



NUMINOS® L | 105



NUMINOS® XL | 105



NUMINOS® S | 108



NUMINOS® M | 108



NUMINOS® L | 109



NUMINOS® XL | 109



NUMINOS® S | 112



NUMINOS® M | 112



NUMINOS® L | 113



NUMINOS® XL | 113



NUMINOS® ZOOM M | 115

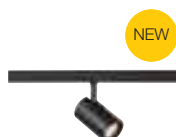

NEW



NUMINOS® 48V XS | 468

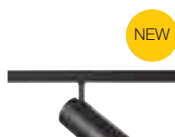

NEW



NUMINOS® 48V S | 468



NEW



NUMINOS® 48V XS | 470



NEW



NUMINOS® 48V S | 470

OCCULDAS



 OCCULDAS 14 | 230



 OCCULDAS 23 | 230



 OCCULDAS 13 | 262



 OCCULDAS 23 | 262

OCULUS



 OCULUS | 229



 OCULUS | 258



 OCULUS | 294



 OCULUS | 355

NEW

ONE®



 ONE® 60 | 188



 ONE® 60 | 188



 ONE® 80 | 188



 ONE® 80 | 188



 ONE® DOUBLE | 189



 ONE® TRIPLE | 189



 ONE® CUBE | 189



 ONE® CUBE | 189



 ONE® LINEAR 100 | 191



 ONE® LINEAR 140 | 191



 ONE® 40 | 193



 ONE® 60 | 193

NEW

NEW

NEW

NEW



 ONE® 40 TRACK | 194



 ONE® STRAIGHT | 196



 ONE® BOW | 197



OVALISK



LED
OVALISK 75/100 | 653



LED
OVALISK
SENSOR | 757



LED
OVALISK | 757



LED
OVALISK | 797

PANEL



LED
LED PANEL | 243



LED
PANEL 60 | 274



LED
PANEL | 275



LED
PANEL 60 | 275



LED
PANEL | 275



LED
PANEL 60 | 289



LED
PANEL TRACK | 507



LED
PANEL TRACK | 507

PANTILO



SCKET
PANTILO
ROPE 19 | 279



SCKET
PANTILO
ROPE 20 | 279



SCKET
PANTILO
ROPE 27 | 279



SCKET
PANTILO
OVAL | 281



SCKET
PANTILO 20 | 281



SCKET
PANTILO 28 | 281



SCKET
PANTILO
CONVEX 29/40 | 283

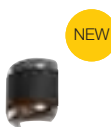

SCKET
PANTILO
ROPE | 345



SCKET
PANTILO
ROPE 19 | 393

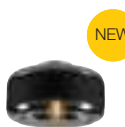

SCKET
PANTILO
ROPE 27 | 393



SCKET
PANTILO
ROPE 19 | 505



SCKET
PANTILO
ROPE 19 | 549

PARA



SCKET

PARA DOME | 318



PARA DOME | 318



PARA DOME | 318



SCKET

PARA 380 | 319

PARA CONE



SCKET

PARA CONE GL | 309



SCKET

PARA CONE 20 | 309



SCKET

PARA CONE 30 | 309



SCKET

PARA CONE GL | 508



SCKET

PARA CONE GL | 508



SCKET

PARA CONE 14 | 509



SCKET

PARA CONE 14 | 509



SCKET

PARA CONE GL | 552



SCKET

PARA CONE GL | 552



SCKET

PARA CONE 14 | 553



SCKET

PARA CONE 14 | 553

PATTA



LED

PATTA-I | 244



LED

PATTA-I | 244



LED

PATTA-I | 245



LED

PATTA-I | 245



LED

PATTA-F | 246



LED

PATTA-F | 247



PEMA



LED
PEMA® | 758



LED
PEMA® | 759



LED
PEMA® | 759



SCKET
PEMA® | 759

PHELIA



SCKET
PHELIA 10 | 310



SCKET
PHELIA 20 | 311



SCKET
PHELIA 25 | 311



SCKET
PHELIA 30 | 311



SCKET
PHELIA | 388



SCKET
PHELIA | 453

PHOTONI



SCKET
PHOTONI 45/75 | 605



SCKET
PHOTONI | 709

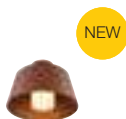

SCKET
PHOTONI | 789

PHOTONIA



SCKET
PHOTONIA | 659



SCKET
PHOTONIA | 659



SCKET
PHOTONIA | 777



SCKET
PHOTONIA | 799

PIKA



SCKET

PIKA | 228



SCKET

PIKA | 228

PLASTRA



SCKET

PLASTRA | 233



SCKET

PLASTRA | 233



SCKET

PLASTRA | 270



LED

PLASTRA | 271



SCKET

PLASTRA 105 | 271



SCKET

PLASTRA 104 | 271



SCKET

PLASTRA | 356



SCKET

PLASTRA | 356



SCKET

PLASTRA | 357



SCKET

PLASTRA | 357



SCKET

PLASTRA | 359



LED

PLASTRA | 359



LED

PLASTRA | 359



SCKET

PLASTRA | 360



SCKET

PLASTRA 101 | 361



SCKET

PLASTRA | 361



SCKET

PLASTRA 104 | 361

POWER TRAIL-LITE



LED

POWER TRAIL-LITE® | 849



LED

POWER TRAIL-LITE® | 849



PURI



SCKET

PURI | 411



SCKET

PURI | 411



SCKET

PURI | 411



SCKET

PURI | 411



SCKET

PURI TRACK | 513



SCKET

PURI TRACK | 513



SCKET

PURI TRACK | 515



SCKET

PURI TRACK | 557



SCKET

PURI TRACK
GLASS | 557

Q-LINE®



LED

Q-LINE® | 253



LED

Q-LINE® | 253



LED

Q-LINE® | 293



LED

Q-LINE® | 293



LED

Q-LINE® | 293



LED

Q-LINE® | 341

QUAD



LED

QUAD FRAME 9 | 240



LED

QUAD FRAME 14 | 364



LED

QUAD FRAME 19 | 364



LED

BIG QUAD | 752



LED

QUAD | 752



LED

QUAD
UP/DOWN 15 | 753



LED

BIG QUAD
UP/DOWN | 755



LED

BIG QUAD | 755

QUADRASS



SCKET

QUADRASS | 307



SCKET

QUADRASS | 375



LED

QUADRASS
SPOT | 375

QUADRASYL



SCKET

QUADRASYL 75 | 682



SCKET

QUADRASYL | 781

QUADRULO



LED

QUADRULO | 639



LED

QUADRULO | 744



SCKET

QUADRULO
SENSOR | 745



SCKET

QUADRULO | 745



LED

QUADRULO | 811

RASCALI



LED

RASCALI 45/65 | 684



LED

RASCALI | 780



ROCCI



LED

ROCCI | 854



LED

ROCCI | 854



LED

ROCCI 200 | 855



LED

ROCCI 200 | 855

ROTOBALL



SCKET

ROTOBALL 25 | 317



SCKET

ROTOBALL 40 | 317



SCKET

ROTOBALL 50 | 317

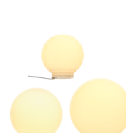

SCKET

ROTOBALL
25/40/50 | 657

ROX



SCKET

ROX ACRYL
30/60/90 | 669



SCKET

ROX UP/DOWN | 767



SCKET

ROX | 767



SCKET

ROX | 801



SCKET

ROX | 801

RUSTY®

 <p>LED RUSTY® SLOT 50/80 640</p>	 <p>SOCKET RUSTY® SLOT 50/80 641</p>	 <p>SOCKET RUSTY® PATHLIGHT 642</p>	 <p>LED RUSTY® 40/70 643</p>	 <p>SOCKET RUSTY® 40/70 643</p>	 <p>SOCKET RUSTY® CONE 24 645</p>
 <p>SOCKET RUSTY® CONE 40/70 645</p>	 <p>SOCKET RUSTY® 40/70 646</p>	 <p>NEW RUSTY® MANA 720</p>	 <p>NEW RUSTY® MANA 720</p>	 <p>LED RUSTY® UP/DOWN 756</p>	 <p>LED RUSTY® UP/DOWN 756</p>

SENDER

 <p>LED SENDER 12 223</p>	 <p>LED SENDER 18 223</p>	 <p>LED SENDER 24 223</p>	 <p>LED SENDER 12 225</p>	 <p>LED SENDER 18 225</p>	 <p>LED SENDER 24 225</p>
 <p>LED SENDER 12 417</p>	 <p>LED SENDER 18 417</p>	 <p>LED SENDER 24 417</p>	 <p>LED SENDER 12 419</p>	 <p>LED SENDER 18 419</p>	 <p>LED SENDER 24 419</p>

SIGHT

 <p>LED SIGHT 60 431</p>	 <p>LED SIGHT 115 431</p>	 <p>LED SIGHT TRACK 550</p>	 <p>LED SIGHT TRACK 550</p>	 <p>LED SIGHT MOVE 551</p>	 <p>LED SIGHT MOVE 551</p>
--	---	---	---	---	--



SIMA



LED

SIMA | 420



LED

SIMA | 420



LED

SIMA | 421



LED

SIMA | 421

SITRA



SCKET

SITRA 360 | 685



SCKET

SITRA 360 SPIKE | 703



SCKET

SITRA 360 SPIKE | 703



LED

SITRA S | 739



LED

SITRA S | 739



LED

SITRA M | 741



LED

SITRA L | 741



SCKET

SITRA CUBE | 741



SCKET

SITRA | 801



SCKET

SITRA 360 | 808



LED

SITRA
UP/DOWN | 765



SCKET

SITRA
UP/DOWN | 765

SLOTS



LED

SLOTS 45/65 | 675



LED

SLOTS | 768

SOLASTO



SCKET

SOLASTO | 857



SCKET

SOLASTO | 857

SOMNILA



LED

SOMNILA SPOT | 384



LED

SOMNILA SPOT | 385



LED

SOMNILA FLEX | 385



LED

SOMNILA FLEX | 385

SQUARE



SCKET

SQUARE
POLE 30/60/90 | 673



SCKET

SQUARE | 779



SCKET

SQUARE TURN | 781

S-TUBE



SCKET

S-TUBE 32/75 | 603



SCKET

S-TUBE | 805



SUN



SCKET

SUN / BIG SUN | 315



NEW

SCKET

TINY SUN | 443



NEW

SCKET

LITTLE SUN | 443

SYNA



NEW

LED

SYNA PLANT | 689



NEW

LED

SYNA GARDEN | 689



LED

SYNA | 689

THEO



SCKET

THEO UP/DOWN | 377



SCKET

THEO PATHLIGHT | 652



SCKET

THEO BRACKET | 701



SCKET

THEO UP/DOWN | 735



LED

BIG THEO BEAM UP/FLOOD DOWN | 735



SCKET

BIG THEO UP/DOWN | 735



LED

BIG THEO FLOOD UP/DOWN | 736



SCKET

THEO | 736



SCKET

BIG THEO | 737



LED

BIG THEO | 737



LED

BIG THEO | 797



SCKET

BIG THEO | 797



SCKET

THEO BRACKET | 808

TRILEDO



SOCKET
TRILEDO | 255



SOCKET
TRILEDO | 255



SOCKET
TRILEDO | 255



LED
TRILEDO | 257



LED
TRILEDO | 257



LED
TRILEDO | 257

TRUKKO



LED
TRUKKO | 330



LED
TRUKKO | 330



LED
TRUKKO | 331



LED
TRUKKO 80 | 331



LED
TRUKKO 60 | 332

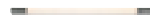

LED
TRUKKO 90 | 332

UNIVERSAL DOWNLIGHT



LED
UNIVERSAL
DOWNLIGHT | 205



LED
UNIVERSAL
DOWNLIGHT | 207



LED
UNIVERSAL
DOWNLIGHT | 208



LED
UNIVERSAL
DOWNLIGHT | 209

VILUA



LED
VILUA S | 763



LED
VILUA L | 763



LED
VILUA | 763



VINOLINA



LED
VINOLINA
ONE | 437, 597



LED
VINOLINA |
437,597



LED
VINOLINA
TWO | 439, 599

WL



LED
WL 149 | 334



SOCKET
WL 149 | 334



SOCKET
WL 106 | 335



SOCKET
WL 106 | 335

WORKLIGHT



LED
WORKLIGHT
PRO 120 | 287



LED
WORKLIGHT
PRO 150 | 287



LED
WORKLIGHT
PRO | 444



LED
WORKLIGHT
PRO | 444



LED
WORKLIGHT | 445



LED
WORKLIGHT | 445

NUMINOS® GIMBLE
1005817



Scopri il configuratore
NUMINOS®
su [slv.com](https://www.slv.com)

NUMINOS®
Downlights (DL)



I colori dei
NUMINOS® DL
possono essere
selezionati
individualmente



nero-nero



nero-bianco



nero-cromo



bianco-nero



bianco-bianco



bianco-cromo



NUMINOS® GIMBLE
ruotabile di 355°
e orientabile di 60°



NUMINOS® MOVE
ruotabile di 355°
e orientabile di 30°



Connettore rapido

XS 200mA Potenza assorbita: 7W Materiale: alluminio/polycarbonato (PC) **S** 250mA Potenza assorbita: 8,6W Materiale: alluminio/polycarbonato (PC)

	2700K	20°	640lm	1005499	73,00 EUR	670lm	1003769	73,00 EUR
		40°	620lm	1005502	73,00 EUR	670lm	1003772	73,00 EUR
		55°	640lm	1005505	73,00 EUR	670lm	1003775	73,00 EUR
	3000K	20°	700lm	1005517	73,00 EUR	690lm	1003793	73,00 EUR
		40°	670lm	1005520	73,00 EUR	690lm	1003796	73,00 EUR
		55°	690lm	1005523	73,00 EUR	690lm	1003799	73,00 EUR
	4000K	20°	720lm	1005535	73,00 EUR	730lm	1003817	73,00 EUR
		40°	700lm	1005538	73,00 EUR	730lm	1003820	73,00 EUR
		55°	710lm	1005541	73,00 EUR	730lm	1003823	73,00 EUR
	2700K	20°	670lm	1005500	73,00 EUR	720lm	1003770	73,00 EUR
		40°	650lm	1005503	73,00 EUR	720lm	1003773	73,00 EUR
		55°	670lm	1005506	73,00 EUR	720lm	1003776	73,00 EUR
	3000K	20°	730lm	1005518	73,00 EUR	730lm	1003794	73,00 EUR
		40°	700lm	1005521	73,00 EUR	730lm	1003797	73,00 EUR
		55°	720lm	1005524	73,00 EUR	730lm	1003800	73,00 EUR
	4000K	20°	750lm	1005536	73,00 EUR	790lm	1003818	73,00 EUR
		40°	730lm	1005539	73,00 EUR	790lm	1003821	73,00 EUR
		55°	740lm	1005542	73,00 EUR	790lm	1003824	73,00 EUR
	2700K	20°	670lm	1005501	73,00 EUR	690lm	1003771	73,00 EUR
		40°	650lm	1005504	73,00 EUR	690lm	1003774	73,00 EUR
		55°	670lm	1005507	73,00 EUR	690lm	1003777	73,00 EUR
	3000K	20°	730lm	1005519	73,00 EUR	700lm	1003795	73,00 EUR
		40°	700lm	1005522	73,00 EUR	700lm	1003798	73,00 EUR
		55°	720lm	1005525	73,00 EUR	700lm	1003801	73,00 EUR
	4000K	20°	750lm	1005537	73,00 EUR	750lm	1003819	73,00 EUR
		40°	730lm	1005540	73,00 EUR	750lm	1003822	73,00 EUR
		55°	740lm	1005543	73,00 EUR	750lm	1003825	73,00 EUR
	2700K	20°	640lm	1005508	73,00 EUR	670lm	1003781	73,00 EUR
		40°	620lm	1005511	73,00 EUR	670lm	1003784	73,00 EUR
		55°	640lm	1005514	73,00 EUR	670lm	1003787	73,00 EUR
	3000K	20°	700lm	1005526	73,00 EUR	690lm	1003805	73,00 EUR
		40°	670lm	1005529	73,00 EUR	690lm	1003808	73,00 EUR
		55°	690lm	1005532	73,00 EUR	690lm	1003811	73,00 EUR
	4000K	20°	720lm	1005544	73,00 EUR	730lm	1003829	73,00 EUR
		40°	700lm	1005547	73,00 EUR	730lm	1003832	73,00 EUR
		55°	710lm	1005550	73,00 EUR	730lm	1003835	73,00 EUR
	2700K	20°	670lm	1005509	73,00 EUR	720lm	1003782	73,00 EUR
		40°	650lm	1005512	73,00 EUR	720lm	1003785	73,00 EUR
		55°	670lm	1005515	73,00 EUR	720lm	1003788	73,00 EUR
	3000K	20°	730lm	1005527	73,00 EUR	730lm	1003806	73,00 EUR
		40°	700lm	1005530	73,00 EUR	730lm	1003809	73,00 EUR
		55°	720lm	1005533	73,00 EUR	730lm	1003812	73,00 EUR
	4000K	20°	750lm	1005545	73,00 EUR	790lm	1003830	73,00 EUR
		40°	730lm	1005548	73,00 EUR	790lm	1003833	73,00 EUR
		55°	740lm	1005551	73,00 EUR	790lm	1003836	73,00 EUR
	2700K	20°	670lm	1005510	73,00 EUR	690lm	1003783	73,00 EUR
		40°	650lm	1005513	73,00 EUR	690lm	1003786	73,00 EUR
		55°	670lm	1005516	73,00 EUR	690lm	1003789	73,00 EUR
	3000K	20°	730lm	1005528	73,00 EUR	700lm	1003807	73,00 EUR
		40°	700lm	1005531	73,00 EUR	700lm	1003810	73,00 EUR
		55°	720lm	1005534	73,00 EUR	700lm	1003813	73,00 EUR
	4000K	20°	750lm	1005546	73,00 EUR	750lm	1003831	73,00 EUR
		40°	730lm	1005549	73,00 EUR	750lm	1003834	73,00 EUR
		55°	740lm	1005552	73,00 EUR	750lm	1003837	73,00 EUR



M 500mA Potenza assorbita: 17,5W Materiale: alluminio/polycarbonato (PC)	L 700mA Potenza assorbita: 25,4W Materiale: alluminio/polycarbonato (PC)	XL 1050mA Potenza assorbita: 37,4W Materiale: alluminio/polycarbonato (PC)
---	---	---

	2700K	20°	1460lm	1003841	87,00 EUR	2150lm	1003913	106,00 EUR	3300lm	1003985	132,00 EUR
		40°	1460lm	1003844	87,00 EUR	2150lm	1003916	106,00 EUR	3300lm	1003988	132,00 EUR
		55°	1460lm	1003847	87,00 EUR	2150lm	1003919	106,00 EUR	3300lm	1003991	132,00 EUR
	3000K	20°	1500lm	1003865	87,00 EUR	2150lm	1003937	106,00 EUR	3300lm	1004009	132,00 EUR
		40°	1500lm	1003868	87,00 EUR	2150lm	1003940	106,00 EUR	3300lm	1004012	132,00 EUR
		55°	1500lm	1003871	87,00 EUR	2150lm	1003943	106,00 EUR	3300lm	1004015	132,00 EUR
	4000K	20°	1600lm	1003889	87,00 EUR	2350lm	1003961	106,00 EUR	3600lm	1004033	132,00 EUR
		40°	1600lm	1003892	87,00 EUR	2350lm	1003964	106,00 EUR	3600lm	1004036	132,00 EUR
		55°	1600lm	1003895	87,00 EUR	2350lm	1003967	106,00 EUR	3600lm	1004039	132,00 EUR
	2700K	20°	1600lm	1003842	87,00 EUR	2250lm	1003914	106,00 EUR	3500lm	1003986	132,00 EUR
		40°	1600lm	1003845	87,00 EUR	2250lm	1003917	106,00 EUR	3500lm	1003989	132,00 EUR
		55°	1600lm	1003848	87,00 EUR	2250lm	1003920	106,00 EUR	3500lm	1003992	132,00 EUR
	3000K	20°	1600lm	1003866	87,00 EUR	2300lm	1003938	106,00 EUR	3550lm	1004010	132,00 EUR
		40°	1600lm	1003869	87,00 EUR	2300lm	1003941	106,00 EUR	3550lm	1004013	132,00 EUR
		55°	1600lm	1003872	87,00 EUR	2300lm	1003944	106,00 EUR	3550lm	1004016	132,00 EUR
	4000K	20°	1750lm	1003890	87,00 EUR	2450lm	1003962	106,00 EUR	3800lm	1004034	132,00 EUR
		40°	1750lm	1003893	87,00 EUR	2450lm	1003965	106,00 EUR	3800lm	1004037	132,00 EUR
		55°	1750lm	1003896	87,00 EUR	2450lm	1003968	106,00 EUR	3800lm	1004040	132,00 EUR
	2700K	20°	1550lm	1003843	87,00 EUR	2150lm	1003915	106,00 EUR	3400lm	1003987	132,00 EUR
		40°	1550lm	1003846	87,00 EUR	2150lm	1003918	106,00 EUR	3400lm	1003990	132,00 EUR
		55°	1550lm	1003849	87,00 EUR	2150lm	1003921	106,00 EUR	3400lm	1003993	132,00 EUR
	3000K	20°	1550lm	1003867	87,00 EUR	2200lm	1003939	106,00 EUR	3500lm	1004011	132,00 EUR
		40°	1550lm	1003870	87,00 EUR	2200lm	1003942	106,00 EUR	3500lm	1004014	132,00 EUR
		55°	1550lm	1003873	87,00 EUR	2200lm	1003945	106,00 EUR	3500lm	1004017	132,00 EUR
	4000K	20°	1660lm	1003891	87,00 EUR	2350lm	1003963	106,00 EUR	3750lm	1004035	132,00 EUR
		40°	1660lm	1003894	87,00 EUR	2350lm	1003966	106,00 EUR	3750lm	1004038	132,00 EUR
		55°	1660lm	1003897	87,00 EUR	2350lm	1003969	106,00 EUR	3750lm	1004041	132,00 EUR
	2700K	20°	1460lm	1003853	87,00 EUR	2150lm	1003925	106,00 EUR	3300lm	1003997	132,00 EUR
		40°	1460lm	1003856	87,00 EUR	2150lm	1003928	106,00 EUR	3300lm	1004000	132,00 EUR
		55°	1460lm	1003859	87,00 EUR	2150lm	1003931	106,00 EUR	3300lm	1004003	132,00 EUR
	3000K	20°	1500lm	1003877	87,00 EUR	2150lm	1003949	106,00 EUR	3300lm	1004021	132,00 EUR
		40°	1500lm	1003880	87,00 EUR	2150lm	1003952	106,00 EUR	3300lm	1004024	132,00 EUR
		55°	1500lm	1003883	87,00 EUR	2150lm	1003955	106,00 EUR	3300lm	1004027	132,00 EUR
	4000K	20°	1600lm	1003901	87,00 EUR	2350lm	1003973	106,00 EUR	3600lm	1004045	132,00 EUR
		40°	1600lm	1003904	87,00 EUR	2350lm	1003976	106,00 EUR	3600lm	1004048	132,00 EUR
		55°	1600lm	1003907	87,00 EUR	2350lm	1003979	106,00 EUR	3600lm	1004051	132,00 EUR
	2700K	20°	1600lm	1003854	87,00 EUR	2250lm	1003926	106,00 EUR	3500lm	1003998	132,00 EUR
		40°	1600lm	1003857	87,00 EUR	2250lm	1003929	106,00 EUR	3500lm	1004001	132,00 EUR
		55°	1600lm	1003860	87,00 EUR	2250lm	1003932	106,00 EUR	3500lm	1004004	132,00 EUR
	3000K	20°	1600lm	1003878	87,00 EUR	2300lm	1003950	106,00 EUR	3550lm	1004022	132,00 EUR
		40°	1600lm	1003881	87,00 EUR	2300lm	1003953	106,00 EUR	3550lm	1004025	132,00 EUR
		55°	1600lm	1003884	87,00 EUR	2300lm	1003956	106,00 EUR	3550lm	1004028	132,00 EUR
	4000K	20°	1750lm	1003902	87,00 EUR	2450lm	1003974	106,00 EUR	3800lm	1004046	132,00 EUR
		40°	1750lm	1003905	87,00 EUR	2450lm	1003977	106,00 EUR	3800lm	1004049	132,00 EUR
		55°	1750lm	1003908	87,00 EUR	2450lm	1003980	106,00 EUR	3800lm	1004052	132,00 EUR
	2700K	20°	1550lm	1003855	87,00 EUR	2150lm	1003927	106,00 EUR	3400lm	1003999	132,00 EUR
		40°	1550lm	1003858	87,00 EUR	2150lm	1003930	106,00 EUR	3400lm	1004002	132,00 EUR
		55°	1550lm	1003861	87,00 EUR	2150lm	1003933	106,00 EUR	3400lm	1004005	132,00 EUR
	3000K	20°	1550lm	1003879	87,00 EUR	2200lm	1003951	106,00 EUR	3500lm	1004023	132,00 EUR
		40°	1550lm	1003882	87,00 EUR	2200lm	1003954	106,00 EUR	3500lm	1004026	132,00 EUR
		55°	1550lm	1003885	87,00 EUR	2200lm	1003957	106,00 EUR	3500lm	1004029	132,00 EUR
	4000K	20°	1660lm	1003903	87,00 EUR	2350lm	1003975	106,00 EUR	3750lm	1004047	132,00 EUR
		40°	1660lm	1003906	87,00 EUR	2350lm	1003978	106,00 EUR	3750lm	1004050	132,00 EUR
		55°	1660lm	1003909	87,00 EUR	2350lm	1003981	106,00 EUR	3750lm	1004053	132,00 EUR



IP20

IK02

L80B50

355°

30°

10

Connettore rapido

XS

200mA
Potenza assorbita: 7W
Materiale: alluminio/polycarbonato (PC)

S

250mA
Potenza assorbita: 8,6W
Materiale: alluminio/polycarbonato (PC)

2700K	20°	640lm	1005553	84,00 EUR	670lm	1005319	92,00 EUR
	40°	620lm	1005556	84,00 EUR	670lm	1005322	92,00 EUR
	55°	640lm	1005559	84,00 EUR	670lm	1005325	92,00 EUR
3000K	20°	700lm	1005571	84,00 EUR	690lm	1005337	92,00 EUR
	40°	670lm	1005574	84,00 EUR	690lm	1005340	92,00 EUR
	55°	690lm	1005577	84,00 EUR	690lm	1005343	92,00 EUR
4000K	20°	720lm	1005589	84,00 EUR	730lm	1005355	92,00 EUR
	40°	700lm	1005592	84,00 EUR	730lm	1005358	92,00 EUR
	55°	710lm	1005595	84,00 EUR	730lm	1005361	92,00 EUR
2700K	20°	670lm	1005554	84,00 EUR	720lm	1005320	92,00 EUR
	40°	650lm	1005557	84,00 EUR	720lm	1005323	92,00 EUR
	55°	670lm	1005560	84,00 EUR	720lm	1005326	92,00 EUR
3000K	20°	730lm	1005572	84,00 EUR	730lm	1005338	92,00 EUR
	40°	700lm	1005575	84,00 EUR	730lm	1005341	92,00 EUR
	55°	720lm	1005578	84,00 EUR	730lm	1005344	92,00 EUR
4000K	20°	750lm	1005590	84,00 EUR	790lm	1005356	92,00 EUR
	40°	730lm	1005593	84,00 EUR	790lm	1005359	92,00 EUR
	55°	740lm	1005596	84,00 EUR	790lm	1005362	92,00 EUR
2700K	20°	670lm	1005555	84,00 EUR	690lm	1005321	92,00 EUR
	40°	650lm	1005558	84,00 EUR	690lm	1005324	92,00 EUR
	55°	670lm	1005561	84,00 EUR	690lm	1005327	92,00 EUR
3000K	20°	730lm	1005573	84,00 EUR	700lm	1005339	92,00 EUR
	40°	700lm	1005576	84,00 EUR	700lm	1005342	92,00 EUR
	55°	720lm	1005579	84,00 EUR	700lm	1005345	92,00 EUR
4000K	20°	750lm	1005591	84,00 EUR	750lm	1005357	92,00 EUR
	40°	730lm	1005594	84,00 EUR	750lm	1005360	92,00 EUR
	55°	740lm	1005597	84,00 EUR	750lm	1005363	92,00 EUR
2700K	20°	640lm	1005562	84,00 EUR	670lm	1005328	92,00 EUR
	40°	620lm	1005565	84,00 EUR	670lm	1005331	92,00 EUR
	55°	640lm	1005568	84,00 EUR	670lm	1005334	92,00 EUR
3000K	20°	700lm	1005580	84,00 EUR	690lm	1005346	92,00 EUR
	40°	670lm	1005583	84,00 EUR	690lm	1005349	92,00 EUR
	55°	690lm	1005586	84,00 EUR	690lm	1005352	92,00 EUR
4000K	20°	720lm	1005598	84,00 EUR	730lm	1005364	92,00 EUR
	40°	700lm	1005603	84,00 EUR	730lm	1005367	92,00 EUR
	55°	710lm	1005606	84,00 EUR	730lm	1005370	92,00 EUR
2700K	20°	670lm	1005563	84,00 EUR	720lm	1005329	92,00 EUR
	40°	650lm	1005566	84,00 EUR	720lm	1005332	92,00 EUR
	55°	670lm	1005569	84,00 EUR	720lm	1005335	92,00 EUR
3000K	20°	730lm	1005581	84,00 EUR	730lm	1005347	92,00 EUR
	40°	700lm	1005584	84,00 EUR	730lm	1005350	92,00 EUR
	55°	720lm	1005587	84,00 EUR	730lm	1005353	92,00 EUR
4000K	20°	750lm	1005599	84,00 EUR	790lm	1005365	92,00 EUR
	40°	730lm	1005604	84,00 EUR	790lm	1005368	92,00 EUR
	55°	740lm	1005607	84,00 EUR	790lm	1005371	92,00 EUR
2700K	20°	670lm	1005564	84,00 EUR	690lm	1005330	92,00 EUR
	40°	650lm	1005567	84,00 EUR	690lm	1005333	92,00 EUR
	55°	670lm	1005570	84,00 EUR	690lm	1005336	92,00 EUR
3000K	20°	730lm	1005582	84,00 EUR	700lm	1005348	92,00 EUR
	40°	700lm	1005585	84,00 EUR	700lm	1005351	92,00 EUR
	55°	720lm	1005588	84,00 EUR	700lm	1005354	92,00 EUR
4000K	20°	750lm	1005600	84,00 EUR	750lm	1005366	92,00 EUR
	40°	730lm	1005605	84,00 EUR	750lm	1005369	92,00 EUR
	55°	740lm	1005608	84,00 EUR	750lm	1005372	92,00 EUR



M 500mA Potenza assorbita: 17,5W Materiale: alluminio/polycarbonato (PC)	L 700mA Potenza assorbita: 25,4W Materiale: alluminio/polycarbonato (PC)	XL 1050mA Potenza assorbita: 37,4W Materiale: alluminio/polycarbonato (PC)
---	---	---

	2700K	20°	1460lm	1003553	102,00 EUR	2150lm	1003625	122,00 EUR	3300lm	1003697	152,00 EUR
		40°	1460lm	1003556	102,00 EUR	2150lm	1003628	122,00 EUR	3300lm	1003700	152,00 EUR
		55°	1460lm	1003559	102,00 EUR	2150lm	1003631	122,00 EUR	3300lm	1003703	152,00 EUR
	3000K	20°	1500lm	1003577	102,00 EUR	2150lm	1003649	122,00 EUR	3300lm	1003721	152,00 EUR
		40°	1500lm	1003580	102,00 EUR	2150lm	1003652	122,00 EUR	3300lm	1003724	152,00 EUR
		55°	1500lm	1003583	102,00 EUR	2150lm	1003655	122,00 EUR	3300lm	1003727	152,00 EUR
	4000K	20°	1600lm	1003601	102,00 EUR	2350lm	1003673	122,00 EUR	3600lm	1003745	152,00 EUR
		40°	1600lm	1003604	102,00 EUR	2350lm	1003676	122,00 EUR	3600lm	1003748	152,00 EUR
		55°	1600lm	1003607	102,00 EUR	2350lm	1003679	122,00 EUR	3600lm	1003751	152,00 EUR
	2700K	20°	1600lm	1003554	102,00 EUR	2250lm	1003626	122,00 EUR	3500lm	1003698	152,00 EUR
		40°	1600lm	1003557	102,00 EUR	2250lm	1003629	122,00 EUR	3500lm	1003701	152,00 EUR
		55°	1600lm	1003560	102,00 EUR	2250lm	1003632	122,00 EUR	3500lm	1003704	152,00 EUR
	3000K	20°	1600lm	1003578	102,00 EUR	2300lm	1003650	122,00 EUR	3550lm	1003722	152,00 EUR
		40°	1600lm	1003581	102,00 EUR	2300lm	1003653	122,00 EUR	3550lm	1003725	152,00 EUR
		55°	1600lm	1003584	102,00 EUR	2300lm	1003656	122,00 EUR	3550lm	1003728	152,00 EUR
	4000K	20°	1750lm	1003602	102,00 EUR	2450lm	1003674	122,00 EUR	3800lm	1003746	152,00 EUR
		40°	1750lm	1003605	102,00 EUR	2450lm	1003677	122,00 EUR	3800lm	1003749	152,00 EUR
		55°	1750lm	1003608	102,00 EUR	2450lm	1003680	122,00 EUR	3800lm	1003752	152,00 EUR
	2700K	20°	1550lm	1003555	102,00 EUR	2150lm	1003627	122,00 EUR	3400lm	1003699	152,00 EUR
		40°	1550lm	1003558	102,00 EUR	2150lm	1003630	122,00 EUR	3400lm	1003702	152,00 EUR
		55°	1550lm	1003561	102,00 EUR	2150lm	1003633	122,00 EUR	3400lm	1003705	152,00 EUR
	3000K	20°	1550lm	1003579	102,00 EUR	2200lm	1003651	122,00 EUR	3500lm	1003723	152,00 EUR
		40°	1550lm	1003582	102,00 EUR	2200lm	1003654	122,00 EUR	3500lm	1003726	152,00 EUR
		55°	1550lm	1003585	102,00 EUR	2200lm	1003657	122,00 EUR	3500lm	1003729	152,00 EUR
	4000K	20°	1660lm	1003603	102,00 EUR	2350lm	1003675	122,00 EUR	3750lm	1003747	152,00 EUR
		40°	1660lm	1003606	102,00 EUR	2350lm	1003678	122,00 EUR	3750lm	1003750	152,00 EUR
		55°	1660lm	1003609	102,00 EUR	2350lm	1003681	122,00 EUR	3750lm	1003753	152,00 EUR
	2700K	20°	1460lm	1003565	102,00 EUR	2150lm	1003637	122,00 EUR	3300lm	1003709	152,00 EUR
		40°	1460lm	1003568	102,00 EUR	2150lm	1003640	122,00 EUR	3300lm	1003712	152,00 EUR
		55°	1460lm	1003571	102,00 EUR	2150lm	1003643	122,00 EUR	3300lm	1003715	152,00 EUR
	3000K	20°	1500lm	1003589	102,00 EUR	2150lm	1003661	122,00 EUR	3300lm	1003733	152,00 EUR
		40°	1500lm	1003592	102,00 EUR	2150lm	1003664	122,00 EUR	3300lm	1003736	152,00 EUR
		55°	1500lm	1003595	102,00 EUR	2150lm	1003667	122,00 EUR	3300lm	1003739	152,00 EUR
	4000K	20°	1600lm	1003613	102,00 EUR	2350lm	1003685	122,00 EUR	3600lm	1003757	152,00 EUR
		40°	1600lm	1003616	102,00 EUR	2350lm	1003688	122,00 EUR	3600lm	1003760	152,00 EUR
		55°	1600lm	1003619	102,00 EUR	2350lm	1003691	122,00 EUR	3600lm	1003763	152,00 EUR
	2700K	20°	1600lm	1003566	102,00 EUR	2250lm	1003638	122,00 EUR	3500lm	1003710	152,00 EUR
		40°	1600lm	1003569	102,00 EUR	2250lm	1003641	122,00 EUR	3500lm	1003713	152,00 EUR
		55°	1600lm	1003572	102,00 EUR	2250lm	1003644	122,00 EUR	3500lm	1003716	152,00 EUR
	3000K	20°	1600lm	1003590	102,00 EUR	2300lm	1003662	122,00 EUR	3550lm	1003734	152,00 EUR
		40°	1600lm	1003593	102,00 EUR	2300lm	1003665	122,00 EUR	3550lm	1003737	152,00 EUR
		55°	1600lm	1003596	102,00 EUR	2300lm	1003668	122,00 EUR	3550lm	1003740	152,00 EUR
	4000K	20°	1750lm	1003614	102,00 EUR	2450lm	1003686	122,00 EUR	3800lm	1003758	152,00 EUR
		40°	1750lm	1003617	102,00 EUR	2450lm	1003689	122,00 EUR	3800lm	1003761	152,00 EUR
		55°	1750lm	1003620	102,00 EUR	2450lm	1003692	122,00 EUR	3800lm	1003764	152,00 EUR
	2700K	20°	1550lm	1003567	102,00 EUR	2150lm	1003639	122,00 EUR	3400lm	1003711	152,00 EUR
		40°	1550lm	1003570	102,00 EUR	2150lm	1003642	122,00 EUR	3400lm	1003714	152,00 EUR
		55°	1550lm	1003573	102,00 EUR	2150lm	1003645	122,00 EUR	3400lm	1003717	152,00 EUR
	3000K	20°	1550lm	1003591	102,00 EUR	2200lm	1003663	122,00 EUR	3500lm	1003735	152,00 EUR
		40°	1550lm	1003594	102,00 EUR	2200lm	1003666	122,00 EUR	3500lm	1003738	152,00 EUR
		55°	1550lm	1003597	102,00 EUR	2200lm	1003669	122,00 EUR	3500lm	1003741	152,00 EUR
	4000K	20°	1660lm	1003615	102,00 EUR	2350lm	1003687	122,00 EUR	3750lm	1003759	152,00 EUR
		40°	1660lm	1003618	102,00 EUR	2350lm	1003690	122,00 EUR	3750lm	1003762	152,00 EUR
		55°	1660lm	1003621	102,00 EUR	2350lm	1003693	122,00 EUR	3750lm	1003765	152,00 EUR

NUMINOS® GIMBLE DL



35°

60°

10







Connettore rapido

XS

200mA
Potenza assorbita: 7W
Materiale: alluminio/polycarbonato (PC)

S

250mA
Potenza assorbita: 8,6W
Materiale: alluminio/polycarbonato (PC)

	2700K	20°	640lm	1005813	92,00 EUR	670lm	1005867	102,00 EUR
		40°	620lm	1005816	92,00 EUR	670lm	1005870	102,00 EUR
		55°	640lm	1005819	92,00 EUR	670lm	1005873	102,00 EUR
	3000K	20°	700lm	1005831	92,00 EUR	690lm	1005885	102,00 EUR
		40°	670lm	1005834	92,00 EUR	690lm	1005888	102,00 EUR
		55°	690lm	1005837	92,00 EUR	690lm	1005891	102,00 EUR
	4000K	20°	720lm	1005849	92,00 EUR	730lm	1005903	102,00 EUR
		40°	700lm	1005852	92,00 EUR	730lm	1005906	102,00 EUR
		55°	710lm	1005855	92,00 EUR	730lm	1005909	102,00 EUR
	2700K	20°	670lm	1005814	92,00 EUR	720lm	1005868	102,00 EUR
		40°	650lm	1005817	92,00 EUR	720lm	1005871	102,00 EUR
		55°	670lm	1005820	92,00 EUR	720lm	1005874	102,00 EUR
	3000K	20°	730lm	1005832	92,00 EUR	730lm	1005886	102,00 EUR
		40°	700lm	1005835	92,00 EUR	730lm	1005889	102,00 EUR
		55°	720lm	1005838	92,00 EUR	730lm	1005892	102,00 EUR
	4000K	20°	750lm	1005850	92,00 EUR	790lm	1005904	102,00 EUR
		40°	730lm	1005853	92,00 EUR	790lm	1005907	102,00 EUR
		55°	740lm	1005856	92,00 EUR	790lm	1005910	102,00 EUR
	2700K	20°	670lm	1005815	92,00 EUR	690lm	1005869	102,00 EUR
		40°	650lm	1005818	92,00 EUR	690lm	1005872	102,00 EUR
		55°	670lm	1005821	92,00 EUR	690lm	1005875	102,00 EUR
	3000K	20°	730lm	1005833	92,00 EUR	700lm	1005887	102,00 EUR
		40°	700lm	1005836	92,00 EUR	700lm	1005890	102,00 EUR
		55°	720lm	1005839	92,00 EUR	700lm	1005893	102,00 EUR
	4000K	20°	750lm	1005851	92,00 EUR	750lm	1005905	102,00 EUR
		40°	730lm	1005854	92,00 EUR	750lm	1005908	102,00 EUR
		55°	740lm	1005857	92,00 EUR	750lm	1005911	102,00 EUR
	2700K	20°	640lm	1005822	92,00 EUR	670lm	1005876	102,00 EUR
		40°	620lm	1005825	92,00 EUR	670lm	1005879	102,00 EUR
		55°	640lm	1005828	92,00 EUR	670lm	1005882	102,00 EUR
	3000K	20°	700lm	1005840	92,00 EUR	690lm	1005894	102,00 EUR
		40°	670lm	1005843	92,00 EUR	690lm	1005897	102,00 EUR
		55°	690lm	1005846	92,00 EUR	690lm	1005900	102,00 EUR
	4000K	20°	720lm	1005858	92,00 EUR	730lm	1005912	102,00 EUR
		40°	700lm	1005861	92,00 EUR	730lm	1005915	102,00 EUR
		55°	710lm	1005864	92,00 EUR	730lm	1005918	102,00 EUR
	2700K	20°	670lm	1005823	92,00 EUR	720lm	1005877	102,00 EUR
		40°	650lm	1005826	92,00 EUR	720lm	1005880	102,00 EUR
		55°	670lm	1005829	92,00 EUR	720lm	1005883	102,00 EUR
	3000K	20°	730lm	1005841	92,00 EUR	730lm	1005895	102,00 EUR
		40°	700lm	1005844	92,00 EUR	730lm	1005898	102,00 EUR
		55°	720lm	1005847	92,00 EUR	730lm	1005901	102,00 EUR
	4000K	20°	750lm	1005859	92,00 EUR	790lm	1005913	102,00 EUR
		40°	730lm	1005862	92,00 EUR	790lm	1005916	102,00 EUR
		55°	740lm	1005865	92,00 EUR	790lm	1005919	102,00 EUR
	2700K	20°	670lm	1005824	92,00 EUR	690lm	1005878	102,00 EUR
		40°	650lm	1005827	92,00 EUR	690lm	1005881	102,00 EUR
		55°	670lm	1005830	92,00 EUR	690lm	1005884	102,00 EUR
	3000K	20°	730lm	1005842	92,00 EUR	700lm	1005896	102,00 EUR
		40°	700lm	1005845	92,00 EUR	700lm	1005899	102,00 EUR
		55°	720lm	1005848	92,00 EUR	700lm	1005902	102,00 EUR
	4000K	20°	750lm	1005860	92,00 EUR	750lm	1005914	102,00 EUR
		40°	730lm	1005863	92,00 EUR	750lm	1005917	102,00 EUR
		55°	740lm	1005866	92,00 EUR	750lm	1005920	102,00 EUR



M 500mA Potenza assorbita: 17,5W Materiale: alluminio/polycarbonato (PC)	L 700mA Potenza assorbita: 25,4W Materiale: alluminio/polycarbonato (PC)	XL 1000/1050mA Potenza assorbita: 37,4W Materiale: alluminio/polycarbonato (PC)
---	---	--

	2700K	20°	1460lm	1005921	112,00 EUR	2150lm	1005975	132,00 EUR	3300lm	1006029	155,00 EUR
		40°	1460lm	1005924	112,00 EUR	2150lm	1005978	132,00 EUR	3300lm	1006032	155,00 EUR
		55°	1460lm	1005927	112,00 EUR	2150lm	1005981	132,00 EUR	3300lm	1006035	155,00 EUR
	3000K	20°	1500lm	1005939	112,00 EUR	2150lm	1005993	132,00 EUR	3300lm	1006047	155,00 EUR
		40°	1500lm	1005942	112,00 EUR	2150lm	1005996	132,00 EUR	3300lm	1006050	155,00 EUR
		55°	1500lm	1005945	112,00 EUR	2150lm	1005999	132,00 EUR	3300lm	1006053	155,00 EUR
	4000K	20°	1600lm	1005957	112,00 EUR	2350lm	1006011	132,00 EUR	3600lm	1006065	155,00 EUR
		40°	1600lm	1005960	112,00 EUR	2350lm	1006014	132,00 EUR	3600lm	1006068	155,00 EUR
		55°	1600lm	1005963	112,00 EUR	2350lm	1006017	132,00 EUR	3600lm	1006071	155,00 EUR
	2700K	20°	1600lm	1005922	112,00 EUR	2250lm	1005976	132,00 EUR	3500lm	1006030	155,00 EUR
		40°	1600lm	1005925	112,00 EUR	2250lm	1005979	132,00 EUR	3500lm	1006033	155,00 EUR
		55°	1600lm	1005928	112,00 EUR	2250lm	1005982	132,00 EUR	3500lm	1006036	155,00 EUR
	3000K	20°	1600lm	1005940	112,00 EUR	2300lm	1005994	132,00 EUR	3550lm	1006048	155,00 EUR
		40°	1600lm	1005943	112,00 EUR	2300lm	1005997	132,00 EUR	3550lm	1006051	155,00 EUR
		55°	1600lm	1005946	112,00 EUR	2300lm	1006000	132,00 EUR	3550lm	1006054	155,00 EUR
	4000K	20°	1750lm	1005958	112,00 EUR	2450lm	1006012	132,00 EUR	3800lm	1006066	155,00 EUR
		40°	1750lm	1005961	112,00 EUR	2450lm	1006015	132,00 EUR	3800lm	1006069	155,00 EUR
		55°	1750lm	1005964	112,00 EUR	2450lm	1006018	132,00 EUR	3800lm	1006072	155,00 EUR
	2700K	20°	1550lm	1005923	112,00 EUR	2150lm	1005977	132,00 EUR	3400lm	1006031	155,00 EUR
		40°	1550lm	1005926	112,00 EUR	2150lm	1005980	132,00 EUR	3400lm	1006034	155,00 EUR
		55°	1550lm	1005929	112,00 EUR	2150lm	1005983	132,00 EUR	3400lm	1006037	155,00 EUR
	3000K	20°	1550lm	1005941	112,00 EUR	2200lm	1005995	132,00 EUR	3500lm	1006049	155,00 EUR
		40°	1550lm	1005944	112,00 EUR	2200lm	1005998	132,00 EUR	3500lm	1006052	155,00 EUR
		55°	1550lm	1005947	112,00 EUR	2200lm	1006001	132,00 EUR	3500lm	1006055	155,00 EUR
	4000K	20°	1660lm	1005959	112,00 EUR	2350lm	1006013	132,00 EUR	3750lm	1006067	155,00 EUR
		40°	1660lm	1005962	112,00 EUR	2350lm	1006016	132,00 EUR	3750lm	1006070	155,00 EUR
		55°	1660lm	1005965	112,00 EUR	2350lm	1006019	132,00 EUR	3750lm	1006073	155,00 EUR
	2700K	20°	1460lm	1005930	112,00 EUR	2150lm	1005984	132,00 EUR	3300lm	1006038	155,00 EUR
		40°	1460lm	1005933	112,00 EUR	2150lm	1005987	132,00 EUR	3300lm	1006041	155,00 EUR
		55°	1460lm	1005936	112,00 EUR	2150lm	1005990	132,00 EUR	3300lm	1006044	155,00 EUR
	3000K	20°	1500lm	1005948	112,00 EUR	2150lm	1006002	132,00 EUR	3300lm	1006056	155,00 EUR
		40°	1500lm	1005951	112,00 EUR	2150lm	1006005	132,00 EUR	3300lm	1006059	155,00 EUR
		55°	1500lm	1005954	112,00 EUR	2150lm	1006008	132,00 EUR	3300lm	1006062	155,00 EUR
	4000K	20°	1600lm	1005966	112,00 EUR	2350lm	1006020	132,00 EUR	3600lm	1006074	155,00 EUR
		40°	1600lm	1005969	112,00 EUR	2350lm	1006023	132,00 EUR	3600lm	1006077	155,00 EUR
		55°	1600lm	1005972	112,00 EUR	2350lm	1006026	132,00 EUR	3600lm	1006080	155,00 EUR
	2700K	20°	1600lm	1005931	112,00 EUR	2250lm	1005985	132,00 EUR	3500lm	1006039	155,00 EUR
		40°	1600lm	1005934	112,00 EUR	2250lm	1005988	132,00 EUR	3500lm	1006042	155,00 EUR
		55°	1600lm	1005937	112,00 EUR	2250lm	1005991	132,00 EUR	3500lm	1006045	155,00 EUR
	3000K	20°	1600lm	1005949	112,00 EUR	2300lm	1006003	132,00 EUR	3550lm	1006057	155,00 EUR
		40°	1600lm	1005952	112,00 EUR	2300lm	1006006	132,00 EUR	3550lm	1006060	155,00 EUR
		55°	1600lm	1005955	112,00 EUR	2300lm	1006009	132,00 EUR	3550lm	1006063	155,00 EUR
	4000K	20°	1750lm	1005967	112,00 EUR	2450lm	1006021	132,00 EUR	3800lm	1006075	155,00 EUR
		40°	1750lm	1005970	112,00 EUR	2450lm	1006024	132,00 EUR	3800lm	1006078	155,00 EUR
		55°	1750lm	1005973	112,00 EUR	2450lm	1006027	132,00 EUR	3800lm	1006081	155,00 EUR
	2700K	20°	1550lm	1005932	112,00 EUR	2150lm	1005986	132,00 EUR	3400lm	1006040	155,00 EUR
		40°	1550lm	1005935	112,00 EUR	2150lm	1005989	132,00 EUR	3400lm	1006043	155,00 EUR
		55°	1550lm	1005938	112,00 EUR	2150lm	1005992	132,00 EUR	3400lm	1006046	155,00 EUR
	3000K	20°	1550lm	1005950	112,00 EUR	2200lm	1006004	132,00 EUR	3500lm	1006058	155,00 EUR
		40°	1550lm	1005953	112,00 EUR	2200lm	1006007	132,00 EUR	3500lm	1006061	155,00 EUR
		55°	1550lm	1005956	112,00 EUR	2200lm	1006010	132,00 EUR	3500lm	1006064	155,00 EUR
	4000K	20°	1660lm	1005968	112,00 EUR	2350lm	1006022	132,00 EUR	3750lm	1006076	155,00 EUR
		40°	1660lm	1005971	112,00 EUR	2350lm	1006025	132,00 EUR	3750lm	1006079	155,00 EUR
		55°	1660lm	1005974	112,00 EUR	2350lm	1006028	132,00 EUR	3750lm	1006082	155,00 EUR

NUMINOS® PROJECTOR
1006978



NUMINOS® PROJECTOR Downlight (DL)

LED
INSIDE

NEW

La modalità di utilizzo del
NUMINOS® PROJECTOR
può essere scelta in
base alle necessità



Ampliamento della
serie NUMINOS® nei
formati XS-L



NUMINOS® PROJECTOR DL Move



L80B50

330°

90°

10

NEW

Connettore rapidor

XS











200mA

Potenza assorbita: 7W Materiale:
alluminio

S

250mA

Potenza assorbita: 8,6W
Materiale: alluminio











	2700K	20°	640lm	1006867	130,00 EUR	670lm	1006921	140,00 EUR
		40°	620lm	1006870	130,00 EUR	670lm	1006924	140,00 EUR
		55°	640lm	1006873	130,00 EUR	670lm	1006927	140,00 EUR
	3000K	20°	700lm	1006885	130,00 EUR	690lm	1006939	140,00 EUR
		40°	670lm	1006888	130,00 EUR	690lm	1006942	140,00 EUR
		55°	690lm	1006891	130,00 EUR	690lm	1006945	140,00 EUR
	2700K	20°	730lm	1006868	130,00 EUR	730lm	1006922	140,00 EUR
		40°	700lm	1006871	130,00 EUR	730lm	1006925	140,00 EUR
		55°	720lm	1006874	130,00 EUR	730lm	1006928	140,00 EUR
	3000K	20°	670lm	1006886	130,00 EUR	690lm	1006940	140,00 EUR
		40°	650lm	1006889	130,00 EUR	690lm	1006943	140,00 EUR
		55°	670lm	1006892	130,00 EUR	690lm	1006946	140,00 EUR
	2700K	20°	670lm	1006869	130,00 EUR	720lm	1006923	140,00 EUR
		40°	650lm	1006872	130,00 EUR	720lm	1006926	140,00 EUR
		55°	670lm	1006875	130,00 EUR	720lm	1006929	140,00 EUR
	3000K	20°	730lm	1006887	130,00 EUR	730lm	1006941	140,00 EUR
		40°	700lm	1006890	130,00 EUR	730lm	1006944	140,00 EUR
		55°	720lm	1006893	130,00 EUR	730lm	1006947	140,00 EUR
	2700K	20°	700lm	1006876	130,00 EUR	690lm	1006930	140,00 EUR
		40°	670lm	1006879	130,00 EUR	690lm	1006933	140,00 EUR
		55°	690lm	1006882	130,00 EUR	690lm	1006936	140,00 EUR
	3000K	20°	670lm	1006894	130,00 EUR	690lm	1006948	140,00 EUR
		40°	650lm	1006897	130,00 EUR	690lm	1006951	140,00 EUR
		55°	670lm	1006900	130,00 EUR	690lm	1006954	140,00 EUR
	2700K	20°	670lm	1006877	130,00 EUR	720lm	1006931	140,00 EUR
		40°	650lm	1006880	130,00 EUR	720lm	1006934	140,00 EUR
		55°	670lm	1006883	130,00 EUR	720lm	1006937	140,00 EUR
	3000K	20°	730lm	1006895	130,00 EUR	730lm	1006949	140,00 EUR
		40°	700lm	1006898	130,00 EUR	730lm	1006952	140,00 EUR
		55°	720lm	1006901	130,00 EUR	730lm	1006955	140,00 EUR
	2700K	20°	670lm	1006878	130,00 EUR	690lm	1006932	140,00 EUR
		40°	650lm	1006881	130,00 EUR	690lm	1006935	140,00 EUR
		55°	670lm	1006884	130,00 EUR	690lm	1006938	140,00 EUR
	3000K	20°	730lm	1006896	130,00 EUR	700lm	1006950	140,00 EUR
		40°	700lm	1006899	130,00 EUR	700lm	1006953	140,00 EUR
		55°	720lm	1006902	130,00 EUR	700lm	1006956	140,00 EUR

Questi apparecchi sono disponibili su richiesta anche nella versione 4000K (escluso XS).
In questo caso i tempi di consegna e i quantitativi minimi d'ordine sono differenti.



M 500mA
Potenza assorbita: 17,5W
Materiale: alluminio

L 700mA
Potenza assorbita: 25,4W
Materiale: alluminio

	2700K	20°	1460lm	1006975	150,00 EUR	2150lm	1007029	160,00 EUR
		40°	1460lm	1006978	150,00 EUR	2150lm	1007032	160,00 EUR
		55°	1460lm	1006981	150,00 EUR	2150lm	1007035	160,00 EUR
	3000K	20°	1500lm	1006993	150,00 EUR	2150lm	1007047	160,00 EUR
		40°	1500lm	1006996	150,00 EUR	2150lm	1007050	160,00 EUR
		55°	1500lm	1006999	150,00 EUR	2150lm	1007053	160,00 EUR
	2700K	20°	1600lm	1006976	150,00 EUR	2300lm	1007030	160,00 EUR
		40°	1600lm	1006979	150,00 EUR	2300lm	1007033	160,00 EUR
		55°	1600lm	1006982	150,00 EUR	2300lm	1007036	160,00 EUR
	3000K	20°	1550lm	1006994	150,00 EUR	2150lm	1007048	160,00 EUR
		40°	1550lm	1006997	150,00 EUR	2150lm	1007051	160,00 EUR
		55°	1550lm	1007000	150,00 EUR	2150lm	1007054	160,00 EUR
	2700K	20°	1600lm	1006977	150,00 EUR	2250lm	1007031	160,00 EUR
		40°	1600lm	1006980	150,00 EUR	2250lm	1007034	160,00 EUR
		55°	1600lm	1006983	150,00 EUR	2250lm	1007037	160,00 EUR
	3000K	20°	1600lm	1006995	150,00 EUR	2300lm	1007049	160,00 EUR
		40°	1600lm	1006998	150,00 EUR	2300lm	1007052	160,00 EUR
		55°	1600lm	1007001	150,00 EUR	2300lm	1007055	160,00 EUR
	2700K	20°	1500lm	1006984	150,00 EUR	2150lm	1007038	160,00 EUR
		40°	1500lm	1006987	150,00 EUR	2150lm	1007041	160,00 EUR
		55°	1500lm	1006990	150,00 EUR	2150lm	1007044	160,00 EUR
	3000K	20°	1550lm	1007002	150,00 EUR	2150lm	1007056	160,00 EUR
		40°	1550lm	1007005	150,00 EUR	2150lm	1007059	160,00 EUR
		55°	1550lm	1007008	150,00 EUR	2150lm	1007062	160,00 EUR
	2700K	20°	1600lm	1006985	150,00 EUR	2250lm	1007039	160,00 EUR
		40°	1600lm	1006988	150,00 EUR	2250lm	1007042	160,00 EUR
		55°	1600lm	1006991	150,00 EUR	2250lm	1007045	160,00 EUR
	3000K	20°	1600lm	1007003	150,00 EUR	2300lm	1007057	160,00 EUR
		40°	1600lm	1007006	150,00 EUR	2300lm	1007060	160,00 EUR
		55°	1600lm	1007009	150,00 EUR	2300lm	1007063	160,00 EUR
	2700K	20°	1550lm	1006986	150,00 EUR	2150lm	1007040	160,00 EUR
		40°	1550lm	1006989	150,00 EUR	2150lm	1007043	160,00 EUR
		55°	1550lm	1006992	150,00 EUR	2150lm	1007046	160,00 EUR
	3000K	20°	1550lm	1007004	150,00 EUR	2200lm	1007058	160,00 EUR
		40°	1550lm	1007007	150,00 EUR	2200lm	1007061	160,00 EUR
		55°	1550lm	1007010	150,00 EUR	2200lm	1007064	160,00 EUR

Questi apparecchi sono disponibili su richiesta anche nella versione 4000K (escluso XS).
In questo caso i tempi di consegna e i quantitativi minimi d'ordine sono differenti.

DRIVER ABBINABILI

XS S M L XL



Driver Led 200mA, 10W QC	bianco	5,8W / 8,4W	-	IP20	L: 6,5 cm, La: 3,9 cm, H: 3,5 cm	1005610	26,00 EUR
Driver Led 200mA, 10W, PHASE QC	bianco	6W / 8,4W	PHASE C		L: 8,5 cm, La: 4,1 cm, H: 3 cm	1005609	35,75 EUR
Driver Led 200mA, 10W, DALI QC	bianco	3,8W / 13,5W	DALI		L: 18 cm, La: 4,5 cm, H: 3 cm	1005611	96,00 EUR
Driver Led 200mA, 12W, DALI + RF Interface QC	bianco	1,5W / 12W	DALI + RF		L: 14,2 cm, La: 4,4 cm, H: 3 cm	1006457	90,00 EUR
Driver Led 250mA, 10W	bianco	6,5W / 10W	-	IP20	L: 6,5 cm, La: 3,9 cm, H: 2 cm	1004058	26,00 EUR
Driver Led 250mA, 10W, PHASE	bianco	7,5W / 10W	PHASE C		L: 8,5 cm, La: 3,9 cm, H: 3 cm	1004055	40,75 EUR
Driver Led 250mA, 20W, DALI	bianco	1,5W / 15W	DALI		L: 15 cm, La: 5,2 cm, H: 2,8 cm	1004067	82,00 EUR
Driver Led 250mA, 12W, DALI + RF Interface QC	bianco	1,5W / 12W	DALI + RF		L: 14,2 cm, La: 4,4 cm, H: 3 cm	1006458	90,00 EUR
Driver Led 500mA, 30W	bianco	15W / 29,5W	-	IP20	L: 14,7 cm, La: 4,3 cm, H: 3 cm	1004064	30,75 EUR
Driver Led 500mA, 30W, PHASE	bianco	12,5W / 21W	PHASE C		L: 11,5 cm, La: 4,1 cm, H: 2,5 cm	1004054	59,00 EUR
Driver Led 500mA, 40W, DALI	bianco	1,5W / 40,6W	DALI		L: 12,3 cm, La: 7,9 cm, H: 2,4 cm	1004069	82,00 EUR
Driver Led 500mA, 42W, DALI + RF Interface QC	bianco	3,5W / 42W	DALI + RF		L: 12,3 cm, La: 7,9 cm, H: 3 cm	1006459	105,00 EUR
Driver Led 700mA, 30W	bianco	15W / 29,5W	-	IP20	L: 14,7 cm, La: 4,3 cm, H: 3 cm	1004062	32,00 EUR
Driver Led 700mA, 30W, PHASE	bianco	21W / 29,4W	PHASE C		L: 11,5 cm, La: 4,4 cm, H: 3 cm	1004065	59,00 EUR
Driver Led 700mA, 40W, DALI	bianco	1,5W / 40,6W	DALI		L: 12,3 cm, La: 7,9 cm, H: 2,4 cm	1004070	82,00 EUR
Driver Led 700mA, 42W, DALI + RF Interface QC	bianco	3,5W / 42W	DALI + RF		L: 12,3 cm, La: 7,9 cm, H: 3 cm	1006460	105,00 EUR
Driver Led 1050mA, 40W	bianco	24W / 44W	-	IP20	L: 9,7 cm, La: 4,3 cm, H: 3 cm	1004059	34,00 EUR
Driver Led 1000mA, 40W, PHASE	bianco	26,3W / 42W	PHASE C		L: 14,5 cm, La: 4 cm, H: 3 cm	1004066	63,00 EUR
Driver Led 1050mA, 50W, DALI	bianco	4,2W / 50W	DALI		L: 12,3 cm, La: 7,9 cm, H: 2,4 cm	1004071	82,00 EUR



Un incasso a plafone obsoleto, spesso dotato ancora di sorgenti luminose tradizionali dovrebbe cedere il passo a un'alternativa energeticamente più efficiente e attenta ai costi. Al momento dello smontaggio spesso il foro sul soffitto è più grande del necessario.

SLV offre la soluzione giusta: gli anelli di riduzione coprono completamente i fori sul soffitto più grandi del necessario e conferiscono a tempo stesso al vostro nuovo e compatto apparecchio una tenuta perfetta. I nostri riduttori si adattano perfettamente al sistema di downlight e spot NUMINOS®



DIFFUSORI E ANELLI DI RIDUZIONE

XS S M L XL



Diffusore NUMINOS® XS	Elipse	IP20	Ø: 3,2 cm, H: 0,2 cm	1005612	4,50 EUR
	Prisma			1005613	5,30 EUR
	Smerigliato			1005614	5,30 EUR
	A nido d'ape			1005615	8,35 EUR
Diffusore NUMINOS® S	Elipse	IP20	Ø: 4 cm, H: 0,2 cm	1004786	4,50 EUR
	Prisma			1004787	5,30 EUR
	Smerigliato			1004788	5,30 EUR
	A nido d'ape			1004789	8,35 EUR
Diffusore NUMINOS® M	Elipse	IP20	Ø: 4,75 cm, H: 0,2 cm	1004790	4,50 EUR
	Prisma			1004791	5,80 EUR
	Smerigliato			1004792	5,80 EUR
	A nido d'ape			1004793	12,60 EUR
Diffusore NUMINOS® L	Elipse	IP20	Ø: 5,65 cm, H: 0,2 cm	1004794	5,80 EUR
	Prisma			1004795	6,45 EUR
	Smerigliato			1004796	6,45 EUR
	A nido d'ape			1004797	16,40 EUR
Diffusore NUMINOS® XL	Elipse	IP20	Ø: 7,1 cm, H: 0,2 cm	1004798	6,45 EUR
	Prisma			1004799	7,10 EUR
	Smerigliato			1004800	7,10 EUR
	A nido d'ape			1004801	21,50 EUR



Anello di riduzione Rotondo	nero	Foro soffitto: 8,5-13 cm	Ø esterno: 16 cm, Ø interno: 7 cm H: 5,3 cm	1006135	18,00 EUR
				bianco	
	nero	Foro soffitto: 12-15 cm	Ø esterno: 16 cm, Ø interno: 9 cm H: 5,3 cm	1006139	15,50 EUR
				bianco	
	nero	Foro soffitto: 14-18 cm	Ø esterno: 24 cm, Ø interno: 12 cm H: 5,3 cm	1006143	19,20 EUR
				bianco	
	nero	Foro soffitto: 17-20 cm	Ø esterno: 24 cm, Ø interno: 15 cm H: 5,3 cm	1006147	18,00 EUR
				bianco	
	nero	Foro soffitto: 20-22 cm	Ø esterno: 24 cm, Ø interno: 18 cm H: 5,3 cm	1006151	16,70 EUR
				bianco	
Anello di riduzione quadrato	nero	Foro soffitto: 8,5-13 cm	Ø interno: 7 cm L: 16 cm, La: 16 cm, H: 5,3 cm	1006137	18,00 EUR
				bianco	
	nero	Foro soffitto: 12-15 cm	Ø interno: 9 cm L: 16 cm, La: 16 cm, H: 5,3 cm	1006141	15,50 EUR
				bianco	
	nero	Foro soffitto: 14-18 cm	Ø interno: 12 cm L: 24 cm, La: 24 cm, H: 5,3 cm	1006145	19,20 EUR
				bianco	
	nero	Foro soffitto: 17-20 cm	Ø interno: 15 cm L: 24 cm, La: 24 cm, H: 5,3 cm	1006149	18,00 EUR
				bianco	
	nero	Foro soffitto: 20-22 cm	Ø interno: 18 cm L: 24 cm, La: 24 cm, H: 5,3 cm	1006153	16,70 EUR
				bianco	

NUMINOS® PROJECTOR

Scegli il tuo NUMINOS® PROJECTOR:

Con sei combinazioni di colore, quattro formati e potenze di sistema, due temperature del colore e tre aperture del fascio luminoso da 20°, 44° e 55° hai davvero l'imbarazzo della scelta.

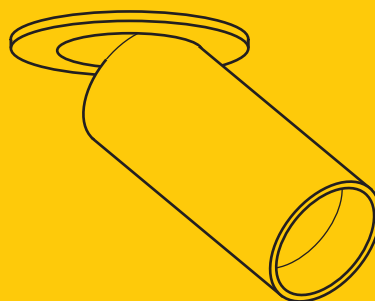
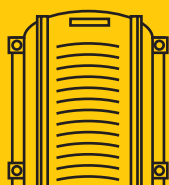
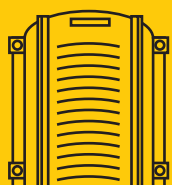

NUMINOS® è un sistema di apparecchi perfettamente coordinati tra loro che armonizzano funzionalità, design e tecnologia. Per progettisti e installatori. Per qualsiasi esigenza. Per la massima versatilità con il minimo sforzo.



Scopri la versatilità della
serie NUMINOS®
su slv.com

Il nuovo NUMINOS® PROJECTOR con il suo ampio range di rotazione e orientamento, rappresenta un eccellente complemento delle downlights NUMINOS®, che offrono le stesse caratteristiche decorative e ottiche.

Disponibile in quattro formati con modulo LED ad alte prestazioni e due temperature del colore.

I driver LED sono da acquistare separatamente.

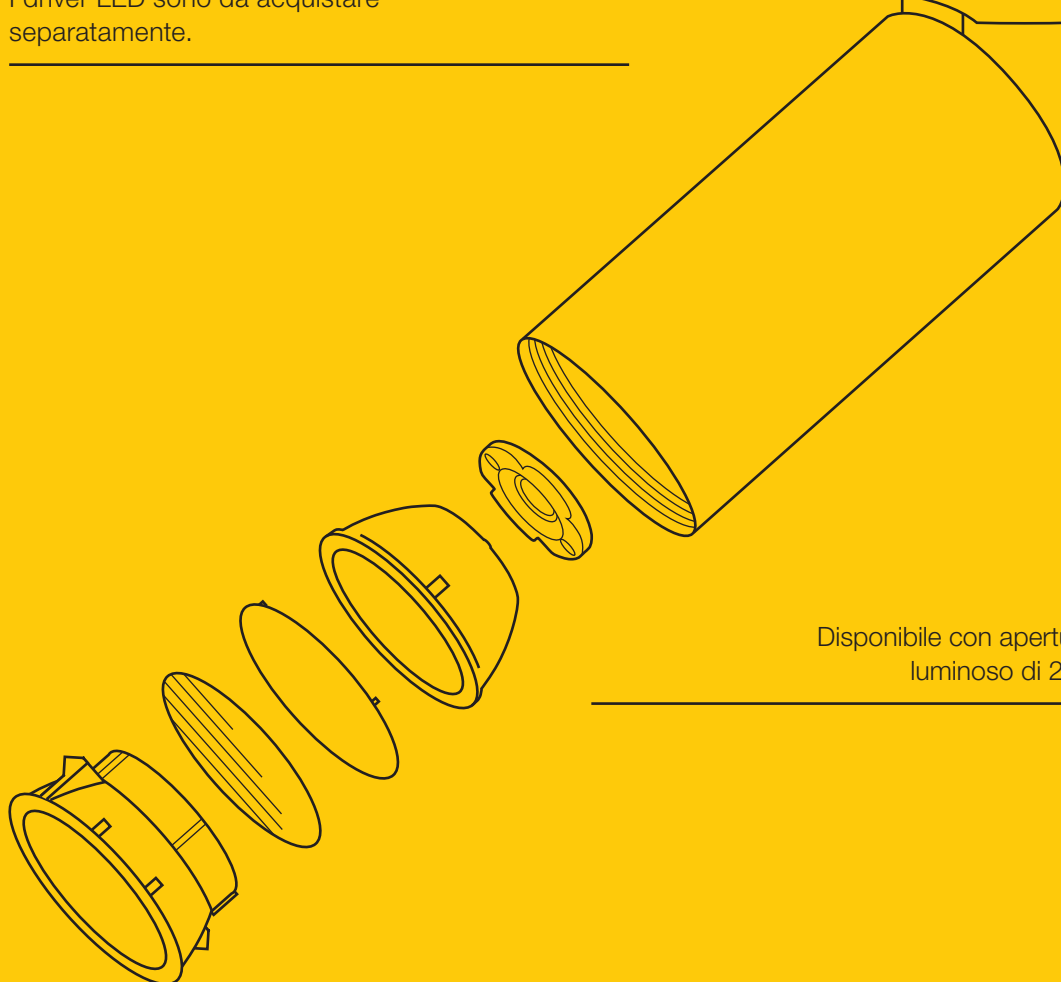
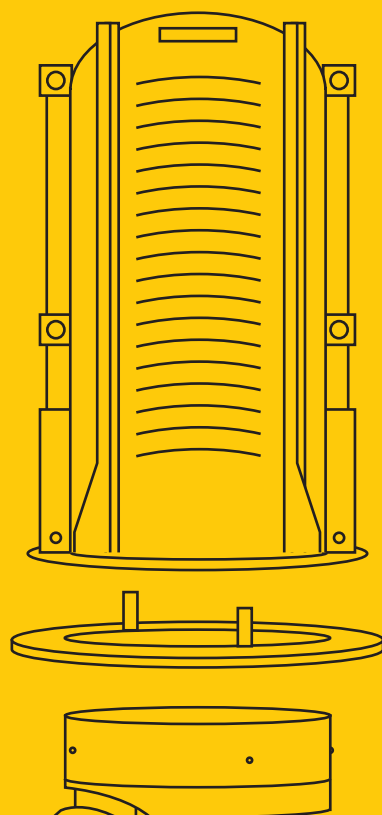

Disponibile con aperture del fascio luminoso di 20° | 40° | 55°.

NUMINOS® CW
1004587

CLUB LOUNGE 1

TIVOLI



NUMINOS®
Lampade da parete e a plafone
(CW)



NUMINOS® CW
Ruotabile di 350°
e orientabile di 90°



Anello decorativo
disponibile anche
in bianco



Anello decorativo NUMINOS® S	Ø: 6,2 cm, H: 2 cm	○	1006167	1,30 EUR
Anello decorativo NUMINOS® M	Ø: 8,2 cm, H: 2,4 cm	○	1006168	2,40 EUR
Anello decorativo NUMINOS® L	Ø: 9,65 cm, H: 2,5 cm	○	1006169	2,40 EUR
Anello decorativo NUMINOS® XL	Ø: 11,66 cm, H: 2,85 cm	○	1006170	3,55 EUR



IP20













L80B50

350°

90°

S 220-240V ~50/60Hz | 250mA
Potenza assorbita: 11W
Materiale: alluminio/policarbonato (PC)

M 220-240V ~50/60Hz | 500mA
Potenza assorbita: 20W
Materiale: alluminio/policarbonato (PC)

	2700K	24°	985lm	1004098	115,00 EUR	1925lm	1004194	145,00 EUR
		36°	985lm	1004099	115,00 EUR	1935lm	1004195	145,00 EUR
		60°	980lm	1004100	115,00 EUR	1885lm	1004196	145,00 EUR
	3000K	24°	1020lm	1004106	115,00 EUR	1955lm	1004202	145,00 EUR
		36°	1020lm	1004107	115,00 EUR	1970lm	1004203	145,00 EUR
		60°	1020lm	1004108	115,00 EUR	1880lm	1004204	145,00 EUR
	4000K	24°	1100lm	1004114	115,00 EUR	2125lm	1004210	145,00 EUR
		36°	1100lm	1004115	115,00 EUR	2120lm	1004211	145,00 EUR
		60°	1100lm	1004116	115,00 EUR	2060lm	1004212	145,00 EUR
	2700K	24°	985lm	1004386	165,00 EUR	1925lm	1004482	197,00 EUR
		36°	985lm	1004387	165,00 EUR	1935lm	1004483	197,00 EUR
		60°	980lm	1004388	165,00 EUR	1885lm	1004484	197,00 EUR
	3000K	24°	1020lm	1004394	165,00 EUR	1955lm	1004490	197,00 EUR
		36°	1020lm	1004395	165,00 EUR	1970lm	1004491	197,00 EUR
		60°	1020lm	1004396	165,00 EUR	1880lm	1004492	197,00 EUR
	4000K	24°	1100lm	1004402	165,00 EUR	2125lm	1004498	197,00 EUR
		36°	1100lm	1004403	165,00 EUR	2120lm	1004499	197,00 EUR
		60°	1100lm	1004404	165,00 EUR	2060lm	1004500	197,00 EUR
	2700K	24°	985lm	1004102	115,00 EUR	1925lm	1004198	145,00 EUR
		36°	985lm	1004103	115,00 EUR	1935lm	1004199	145,00 EUR
		60°	980lm	1004104	115,00 EUR	1885lm	1004200	145,00 EUR
	3000K	24°	1020lm	1004110	115,00 EUR	1955lm	1004206	145,00 EUR
		36°	1020lm	1004111	115,00 EUR	1970lm	1004207	145,00 EUR
		60°	1020lm	1004112	115,00 EUR	1880lm	1004208	145,00 EUR
	4000K	24°	1100lm	1004118	115,00 EUR	2125lm	1004214	145,00 EUR
		36°	1100lm	1004119	115,00 EUR	2120lm	1004215	145,00 EUR
		60°	1100lm	1004120	115,00 EUR	2060lm	1004216	145,00 EUR
	2700K	24°	985lm	1004390	165,00 EUR	1925lm	1004486	197,00 EUR
		36°	985lm	1004391	165,00 EUR	1935lm	1004487	197,00 EUR
		60°	980lm	1004392	165,00 EUR	1885lm	1004488	197,00 EUR
	3000K	24°	1020lm	1004398	165,00 EUR	1955lm	1004494	197,00 EUR
		36°	1020lm	1004399	165,00 EUR	1970lm	1004495	197,00 EUR
		60°	1020lm	1004400	165,00 EUR	1880lm	1004496	197,00 EUR
	4000K	24°	1100lm	1004406	165,00 EUR	2125lm	1004502	197,00 EUR
		36°	1100lm	1004407	165,00 EUR	2120lm	1004503	197,00 EUR
		60°	1100lm	1004408	165,00 EUR	2060lm	1004504	197,00 EUR



<p>L 220-240V ~50/60Hz 700mA Potenza assorbita: 28W Materiale: alluminio/policarbonato (PC)</p>	<p>XL 220-240V ~50/60Hz 900mA Potenza assorbita: 36W Materiale: alluminio/policarbonato (PC)</p>
--	---

	2700K	24°	2440lm	1004290	155,00 EUR	3290lm	1006083	165,00 EUR
		36°	2400lm	1004291	155,00 EUR	3250lm	1006084	165,00 EUR
		60°	2475lm	1004292	155,00 EUR	2980lm	1006085	165,00 EUR
	3000K	24°	2430lm	1004298	155,00 EUR	3530lm	1006089	165,00 EUR
		36°	2340lm	1004299	155,00 EUR	3490lm	1006090	165,00 EUR
		60°	2400lm	1004300	155,00 EUR	3210lm	1006091	165,00 EUR
	4000K	24°	2675lm	1004306	155,00 EUR	3800lm	1006095	165,00 EUR
		36°	2620lm	1004307	155,00 EUR	3760lm	1006096	165,00 EUR
		60°	2715lm	1004308	155,00 EUR	3460lm	1006097	165,00 EUR
	2700K	24°	2440lm	1004578	215,00 EUR	3290lm	1005741	235,00 EUR
		36°	2400lm	1004579	215,00 EUR	3250lm	1005742	235,00 EUR
		60°	2475lm	1004580	215,00 EUR	2980lm	1005743	235,00 EUR
	3000K	24°	2430lm	1004586	215,00 EUR	3530lm	1005747	235,00 EUR
		36°	2340lm	1004587	215,00 EUR	3490lm	1005748	235,00 EUR
		60°	2400lm	1004588	215,00 EUR	3210lm	1005749	235,00 EUR
	4000K	24°	2675lm	1004594	215,00 EUR	3800lm	1005753	235,00 EUR
		36°	2620lm	1004595	215,00 EUR	3760lm	1005754	235,00 EUR
		60°	2715lm	1004596	215,00 EUR	3460lm	1005755	235,00 EUR
	2700K	24°	2440lm	1004294	155,00 EUR	3290lm	1006086	165,00 EUR
		36°	2400lm	1004295	155,00 EUR	3250lm	1006087	165,00 EUR
		60°	2475lm	1004296	155,00 EUR	2980lm	1006088	165,00 EUR
	3000K	24°	2430lm	1004302	155,00 EUR	3530lm	1006092	165,00 EUR
		36°	2340lm	1004303	155,00 EUR	3490lm	1006093	165,00 EUR
		60°	2400lm	1004304	155,00 EUR	3210lm	1006094	165,00 EUR
	4000K	24°	2675lm	1004310	155,00 EUR	3800lm	1006098	165,00 EUR
		36°	2620lm	1004311	155,00 EUR	3760lm	1006099	165,00 EUR
		60°	2715lm	1004312	155,00 EUR	3460lm	1006100	165,00 EUR
	2700K	24°	2440lm	1004582	215,00 EUR	3290lm	1005744	235,00 EUR
		36°	2400lm	1004583	215,00 EUR	3250lm	1005745	235,00 EUR
		60°	2475lm	1004584	215,00 EUR	2980lm	1005746	235,00 EUR
	3000K	24°	2430lm	1004590	215,00 EUR	3530lm	1005750	235,00 EUR
		36°	2340lm	1004591	215,00 EUR	3490lm	1005751	235,00 EUR
		60°	2400lm	1004592	215,00 EUR	3210lm	1005752	235,00 EUR
	4000K	24°	2675lm	1004598	215,00 EUR	3800lm	1005756	235,00 EUR
		36°	2620lm	1004599	215,00 EUR	3760lm	1005757	235,00 EUR
		60°	2715lm	1004600	215,00 EUR	3460lm	1005758	235,00 EUR

NUMINOS® CL
1004227

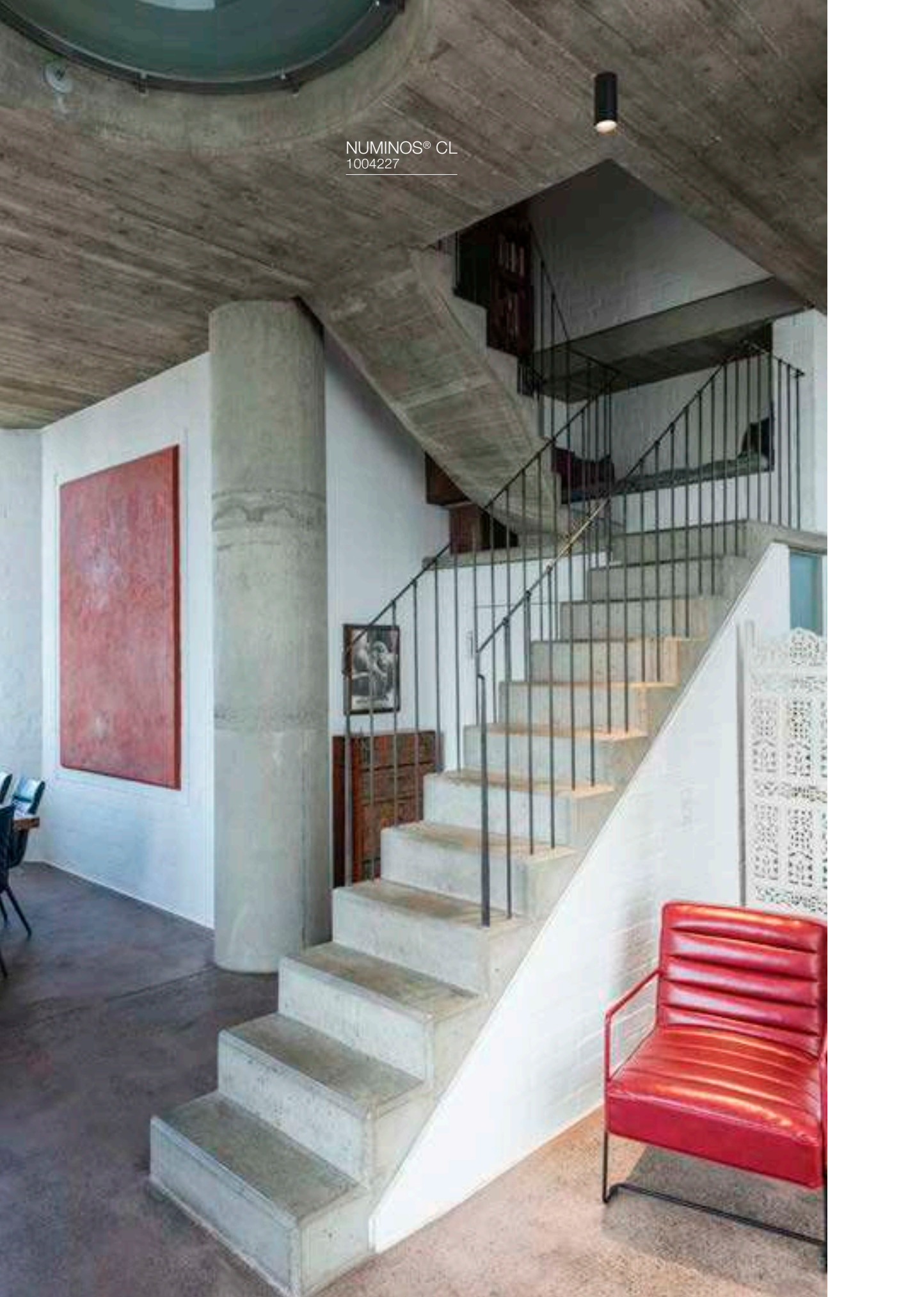



NUMINOS®
Lampade a plafone (CL)



Anello decorativo
disponibile anche
in bianco



Anello decorativo NUMINOS® S	Ø: 6,2 cm, H: 2 cm	○	1006167	1,30 EUR
Anello decorativo NUMINOS® M	Ø: 8,2 cm, H: 2,4 cm	○	1006168	2,40 EUR
Anello decorativo NUMINOS® L	Ø: 9,65 cm, H: 2,5 cm	○	1006169	2,40 EUR
Anello decorativo NUMINOS® XL	Ø: 11,66 cm, H: 2,85 cm	○	1006170	3,55 EUR





Per le dimensioni dettagliate e le informazioni sul montaggio consultare le pagine 118–119



IP20 L80B50

S 220-240V ~50/60Hz | 250mA
Potenza assorbita: 11W
Materiale: alluminio/policarbonato (PC)

M 220-240V ~50/60Hz | 500mA
Potenza assorbita: 20W
Materiale: alluminio/policarbonato (PC)

	2700K	24°	985lm	1004122	102,00 EUR	1925lm	1004218	126,00 EUR
		36°	985lm	1004123	102,00 EUR	1935lm	1004219	126,00 EUR
		60°	980lm	1004124	102,00 EUR	1885lm	1004220	126,00 EUR
	3000K	24°	1020lm	1004130	102,00 EUR	1955lm	1004226	126,00 EUR
		36°	1020lm	1004131	102,00 EUR	1970lm	1004227	126,00 EUR
		60°	1020lm	1004132	102,00 EUR	1880lm	1004228	126,00 EUR
	4000K	24°	1100lm	1004138	102,00 EUR	2125lm	1004234	126,00 EUR
		36°	1100lm	1004139	102,00 EUR	2120lm	1004235	126,00 EUR
		60°	1100lm	1004140	102,00 EUR	2060lm	1004236	126,00 EUR
	2700K	24°	985lm	1004410	150,00 EUR	1925lm	1004506	155,00 EUR
		36°	985lm	1004411	150,00 EUR	1935lm	1004507	155,00 EUR
		60°	980lm	1004412	150,00 EUR	1885lm	1004508	155,00 EUR
	3000K	24°	1020lm	1004418	150,00 EUR	1955lm	1004514	155,00 EUR
		36°	1020lm	1004419	150,00 EUR	1970lm	1004515	155,00 EUR
		60°	1020lm	1004420	150,00 EUR	1880lm	1004516	155,00 EUR
	4000K	24°	1100lm	1004426	150,00 EUR	2125lm	1004522	155,00 EUR
		36°	1100lm	1004427	150,00 EUR	2120lm	1004523	155,00 EUR
		60°	1100lm	1004428	150,00 EUR	2060lm	1004524	155,00 EUR
	2700K	24°	985lm	1004126	102,00 EUR	1925lm	1004222	126,00 EUR
		36°	985lm	1004127	102,00 EUR	1935lm	1004223	126,00 EUR
		60°	980lm	1004128	102,00 EUR	1885lm	1004224	126,00 EUR
	3000K	24°	1020lm	1004134	102,00 EUR	1955lm	1004230	126,00 EUR
		36°	1020lm	1004135	102,00 EUR	1970lm	1004231	126,00 EUR
		60°	1020lm	1004136	102,00 EUR	1880lm	1004232	126,00 EUR
	4000K	24°	1100lm	1004142	102,00 EUR	2125lm	1004238	126,00 EUR
		36°	1100lm	1004143	102,00 EUR	2120lm	1004239	126,00 EUR
		60°	1100lm	1004144	102,00 EUR	2060lm	1004240	126,00 EUR
	2700K	24°	985lm	1004414	150,00 EUR	1925lm	1004510	155,00 EUR
		36°	985lm	1004415	150,00 EUR	1935lm	1004511	155,00 EUR
		60°	980lm	1004416	150,00 EUR	1885lm	1004512	155,00 EUR
	3000K	24°	1020lm	1004422	150,00 EUR	1955lm	1004518	155,00 EUR
		36°	1020lm	1004423	150,00 EUR	1970lm	1004519	155,00 EUR
		60°	1020lm	1004424	150,00 EUR	1880lm	1004520	155,00 EUR
	4000K	24°	1100lm	1004430	150,00 EUR	2125lm	1004526	155,00 EUR
		36°	1100lm	1004431	150,00 EUR	2120lm	1004527	155,00 EUR
		60°	1100lm	1004432	150,00 EUR	2060lm	1004528	155,00 EUR



L 220-240V ~50/60Hz | 700mA
 Potenza assorbita: 28W
 Materiale: alluminio/polycarbonato (PC)

XL 220-240V ~50/60Hz | 900mA
 Potenza assorbita: 36W
 Materiale: alluminio/polycarbonato (PC)

	2700K	24°	2440lm	1004314	146,00 EUR	3290lm	1005687	174,00 EUR
		36°	2400lm	1004315	146,00 EUR	3250lm	1005688	174,00 EUR
		60°	2475lm	1004316	146,00 EUR	2980lm	1005689	174,00 EUR
	3000K	24°	2430lm	1004322	146,00 EUR	3530lm	1005693	174,00 EUR
		36°	2340lm	1004323	146,00 EUR	3490lm	1005694	174,00 EUR
		60°	2400lm	1004324	146,00 EUR	3210lm	1005695	174,00 EUR
	4000K	24°	2675lm	1004330	146,00 EUR	3800lm	1005699	174,00 EUR
		36°	2620lm	1004331	146,00 EUR	3760lm	1005700	174,00 EUR
		60°	2715lm	1004332	146,00 EUR	3460lm	1005701	174,00 EUR
	2700K	24°	2440lm	1004602	198,00 EUR	3290lm	1005759	235,00 EUR
		36°	2400lm	1004603	198,00 EUR	3250lm	1005760	235,00 EUR
		60°	2475lm	1004604	198,00 EUR	2980lm	1005761	235,00 EUR
	3000K	24°	2430lm	1004610	198,00 EUR	3530lm	1005765	235,00 EUR
		36°	2340lm	1004611	198,00 EUR	3490lm	1005766	235,00 EUR
		60°	2400lm	1004612	198,00 EUR	3210lm	1005767	235,00 EUR
	4000K	24°	2675lm	1004618	198,00 EUR	3800lm	1005771	235,00 EUR
		36°	2620lm	1004619	198,00 EUR	3760lm	1005772	235,00 EUR
		60°	2715lm	1004620	198,00 EUR	3460lm	1005773	235,00 EUR
	2700K	24°	2440lm	1004318	146,00 EUR	3290lm	1005690	174,00 EUR
		36°	2400lm	1004319	146,00 EUR	3250lm	1005691	174,00 EUR
		60°	2475lm	1004320	146,00 EUR	2980lm	1005692	174,00 EUR
	3000K	24°	2430lm	1004326	146,00 EUR	3530lm	1005696	174,00 EUR
		36°	2340lm	1004327	146,00 EUR	3490lm	1005697	174,00 EUR
		60°	2400lm	1004328	146,00 EUR	3210lm	1005698	174,00 EUR
	4000K	24°	2675lm	1004334	146,00 EUR	3800lm	1005702	174,00 EUR
		36°	2620lm	1004335	146,00 EUR	3760lm	1005703	174,00 EUR
		60°	2715lm	1004336	146,00 EUR	3460lm	1005704	174,00 EUR
	2700K	24°	2440lm	1004606	198,00 EUR	3290lm	1005762	235,00 EUR
		36°	2400lm	1004607	198,00 EUR	3250lm	1005763	235,00 EUR
		60°	2475lm	1004608	198,00 EUR	2980lm	1005764	235,00 EUR
	3000K	24°	2430lm	1004614	198,00 EUR	3530lm	1005768	235,00 EUR
		36°	2340lm	1004615	198,00 EUR	3490lm	1005769	235,00 EUR
		60°	2400lm	1004616	198,00 EUR	3210lm	1005770	235,00 EUR
	4000K	24°	2675lm	1004622	198,00 EUR	3800lm	1005774	235,00 EUR
		36°	2620lm	1004623	198,00 EUR	3760lm	1005775	235,00 EUR
		60°	2715lm	1004624	198,00 EUR	3460lm	1005776	235,00 EUR

NUMINOS® PD
1005787





NUMINOS®
Sospensioni (PD)



Anello decorativo
disponibile anche
in bianco







Anello decorativo <i>NUMINOS® S</i>	Ø: 6,2 cm, H: 2 cm	○	1006167	1,30 EUR
Anello decorativo <i>NUMINOS® M</i>	Ø: 8,2 cm, H: 2,4 cm	○	1006168	2,40 EUR
Anello decorativo <i>NUMINOS® L</i>	Ø: 9,65 cm, H: 2,5 cm	○	1006169	2,40 EUR
Anello decorativo <i>NUMINOS® XL</i>	Ø: 11,66 cm, H: 2,85 cm	○	1006170	3,55 EUR

Per le dimensioni dettagliate e le informazioni sul montaggio consultare le pagine 118–119



S 220-240V ~50/60Hz | 250mA
Potenza assorbita: 11W
Materiale: alluminio/policarbonato (PC)





M 220-240V ~50/60Hz | 500mA
Potenza assorbita: 20W
Materiale: alluminio/policarbonato (PC)

	2700K	24°	985lm	1004146	140,00 EUR	1925lm	1004242	157,00 EUR
		36°	985lm	1004147	140,00 EUR	1935lm	1004243	157,00 EUR
		60°	980lm	1004148	140,00 EUR	1885lm	1004244	157,00 EUR
	3000K	24°	1020lm	1004154	140,00 EUR	1955lm	1004250	157,00 EUR
		36°	1020lm	1004155	140,00 EUR	1970lm	1004251	157,00 EUR
		60°	1020lm	1004156	140,00 EUR	1880lm	1004252	157,00 EUR
	4000K	24°	1100lm	1004162	140,00 EUR	2125lm	1004258	157,00 EUR
		36°	1100lm	1004163	140,00 EUR	2120lm	1004259	157,00 EUR
		60°	1100lm	1004164	140,00 EUR	2060lm	1004260	157,00 EUR
	2700K	24°	985lm	1004434	198,00 EUR	1925lm	1004530	210,00 EUR
		36°	985lm	1004435	198,00 EUR	1935lm	1004531	210,00 EUR
		60°	980lm	1004436	198,00 EUR	1885lm	1004532	210,00 EUR
	3000K	24°	1020lm	1004442	198,00 EUR	1955lm	1004538	210,00 EUR
		36°	1020lm	1004443	198,00 EUR	1970lm	1004539	210,00 EUR
		60°	1020lm	1004444	198,00 EUR	1880lm	1004540	210,00 EUR
	4000K	24°	1100lm	1004450	198,00 EUR	2125lm	1004546	210,00 EUR
		36°	1100lm	1004451	198,00 EUR	2120lm	1004547	210,00 EUR
		60°	1100lm	1004452	198,00 EUR	2060lm	1004548	210,00 EUR
	2700K	24°	985lm	1004150	140,00 EUR	1925lm	1004246	157,00 EUR
		36°	985lm	1004151	140,00 EUR	1935lm	1004247	157,00 EUR
		60°	980lm	1004152	140,00 EUR	1885lm	1004248	157,00 EUR
	3000K	24°	1020lm	1004158	140,00 EUR	1955lm	1004254	157,00 EUR
		36°	1020lm	1004159	140,00 EUR	1970lm	1004255	157,00 EUR
		60°	1020lm	1004160	140,00 EUR	1880lm	1004256	157,00 EUR
	4000K	24°	1100lm	1004166	140,00 EUR	2125lm	1004262	157,00 EUR
		36°	1100lm	1004167	140,00 EUR	2120lm	1004263	157,00 EUR
		60°	1100lm	1004168	140,00 EUR	2060lm	1004264	157,00 EUR
	2700K	24°	985lm	1004438	198,00 EUR	1925lm	1004534	210,00 EUR
		36°	985lm	1004439	198,00 EUR	1935lm	1004535	210,00 EUR
		60°	980lm	1004440	198,00 EUR	1885lm	1004536	210,00 EUR
	3000K	24°	1020lm	1004446	198,00 EUR	1955lm	1004542	210,00 EUR
		36°	1020lm	1004447	198,00 EUR	1970lm	1004543	210,00 EUR
		60°	1020lm	1004448	198,00 EUR	1880lm	1004544	210,00 EUR
	4000K	24°	1100lm	1004454	198,00 EUR	2125lm	1004550	210,00 EUR
		36°	1100lm	1004455	198,00 EUR	2120lm	1004551	210,00 EUR
		60°	1100lm	1004456	198,00 EUR	2060lm	1004552	210,00 EUR



L 220-240V ~50/60Hz | 700mA
 Potenza assorbita: 28W
 Materiale: alluminio/polycarbonato (PC)

XL 220-240V ~50/60Hz | 900mA
 Potenza assorbita: 36W
 Materiale: alluminio/polycarbonato (PC)

	C	2700K	24°	2440lm	1004338	172,00 EUR	3290lm	1005705	198,00 EUR
			36°	2400lm	1004339	172,00 EUR	3250lm	1005706	198,00 EUR
			60°	2475lm	1004340	172,00 EUR	2980lm	1005707	198,00 EUR
	C	3000K	24°	2430lm	1004346	172,00 EUR	3530lm	1005711	198,00 EUR
			36°	2340lm	1004347	172,00 EUR	3490lm	1005712	198,00 EUR
			60°	2400lm	1004348	172,00 EUR	3210lm	1005713	198,00 EUR
	C	4000K	24°	2675lm	1004354	172,00 EUR	3800lm	1005717	198,00 EUR
			36°	2620lm	1004355	172,00 EUR	3760lm	1005718	198,00 EUR
			60°	2715lm	1004356	172,00 EUR	3460lm	1005719	198,00 EUR
	Dali	2700K	24°	2440lm	1004626	228,00 EUR	3290lm	1005777	254,00 EUR
			36°	2400lm	1004627	228,00 EUR	3250lm	1005778	254,00 EUR
			60°	2475lm	1004628	228,00 EUR	2980lm	1005779	254,00 EUR
	Dali	3000K	24°	2430lm	1004634	228,00 EUR	3530lm	1005783	254,00 EUR
			36°	2340lm	1004635	228,00 EUR	3490lm	1005784	254,00 EUR
			60°	2400lm	1004636	228,00 EUR	3210lm	1005785	254,00 EUR
	Dali	4000K	24°	2675lm	1004642	228,00 EUR	3800lm	1005789	254,00 EUR
			36°	2620lm	1004643	228,00 EUR	3760lm	1005790	254,00 EUR
			60°	2715lm	1004644	228,00 EUR	3460lm	1005791	254,00 EUR
	C	2700K	24°	2440lm	1004342	172,00 EUR	3290lm	1005708	198,00 EUR
			36°	2400lm	1004343	172,00 EUR	3250lm	1005709	198,00 EUR
			60°	2475lm	1004344	172,00 EUR	2980lm	1005710	198,00 EUR
	C	3000K	24°	2430lm	1004350	172,00 EUR	3530lm	1005714	198,00 EUR
			36°	2340lm	1004351	172,00 EUR	3490lm	1005715	198,00 EUR
			60°	2400lm	1004352	172,00 EUR	3210lm	1005716	198,00 EUR
	C	4000K	24°	2675lm	1004358	172,00 EUR	3800lm	1005720	198,00 EUR
			36°	2620lm	1004359	172,00 EUR	3760lm	1005721	198,00 EUR
			60°	2715lm	1004360	172,00 EUR	3460lm	1005722	198,00 EUR
	Dali	2700K	24°	2440lm	1004630	228,00 EUR	3290lm	1005780	254,00 EUR
			36°	2400lm	1004631	228,00 EUR	3250lm	1005781	254,00 EUR
			60°	2475lm	1004632	228,00 EUR	2980lm	1005782	254,00 EUR
	Dali	3000K	24°	2430lm	1004638	228,00 EUR	3530lm	1005786	254,00 EUR
			36°	2340lm	1004639	228,00 EUR	3490lm	1005787	254,00 EUR
			60°	2400lm	1004640	228,00 EUR	3210lm	1005788	254,00 EUR
	Dali	4000K	24°	2675lm	1004646	228,00 EUR	3800lm	1005792	254,00 EUR
			36°	2620lm	1004647	228,00 EUR	3760lm	1005793	254,00 EUR
			60°	2715lm	1004648	228,00 EUR	3460lm	1005794	254,00 EUR

NUMINOS® 3-PH. TRACK
1004083



NUMINOS®
Binario trifase



Scopri gli apparecchi
NUMINOS® per il
binario a 48V alle
pag. 468–471

NUMINOS® 3-PH. TRACK
1004082

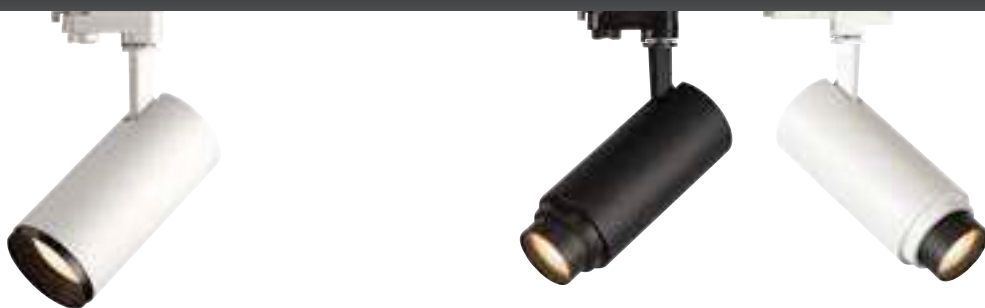

Anello decorativo
disponibile anche
in bianco



Anello decorativo <i>NUMINOS® S</i>	Ø: 6,2 cm, H: 2 cm	○	1006167	1,30 EUR
Anello decorativo <i>NUMINOS® M</i>	Ø: 8,2 cm, H: 2,4 cm	○	1006168	2,40 EUR
Anello decorativo <i>NUMINOS® L</i>	Ø: 9,65 cm, H: 2,5 cm	○	1006169	2,40 EUR
Anello decorativo <i>NUMINOS® XL</i>	Ø: 11,66 cm, H: 2,85 cm	○	1006170	3,55 EUR

Per le dimensioni dettagliate e le informazioni sul montaggio consultare le pagine 118–119



S 220-240V ~50/60Hz | 250mA
Potenza assorbita: 11W
Materiale: alluminio/policarbonato (PC)





M 220-240V ~50/60Hz | 500mA
Potenza assorbita: 20W
Materiale: alluminio/policarbonato (PC)

	2700K	24°	985lm	1004074	115,00 EUR	1925lm	1004170	145,00 EUR
		36°	985lm	1004075	115,00 EUR	1935lm	1004171	145,00 EUR
		60°	980lm	1004076	115,00 EUR	1885lm	1004172	145,00 EUR
	3000K	24°	1020lm	1004082	115,00 EUR	1955lm	1004178	145,00 EUR
		36°	1020lm	1004083	115,00 EUR	1970lm	1004179	145,00 EUR
		60°	1020lm	1004084	115,00 EUR	1880lm	1004180	145,00 EUR
	4000K	24°	1100lm	1004090	115,00 EUR	2125lm	1004186	145,00 EUR
		36°	1100lm	1004091	115,00 EUR	2120lm	1004187	145,00 EUR
		60°	1100lm	1004092	115,00 EUR	2060lm	1004188	145,00 EUR
	2700K	24°	985lm	1004362	165,00 EUR	1925lm	1004458	197,00 EUR
		36°	985lm	1004363	165,00 EUR	1935lm	1004459	197,00 EUR
		60°	980lm	1004364	165,00 EUR	1885lm	1004460	197,00 EUR
	3000K	24°	1020lm	1004370	165,00 EUR	1955lm	1004466	197,00 EUR
		36°	1020lm	1004371	165,00 EUR	1970lm	1004467	197,00 EUR
		60°	1020lm	1004372	165,00 EUR	1880lm	1004468	197,00 EUR
	4000K	24°	1100lm	1004378	165,00 EUR	2125lm	1004474	197,00 EUR
		36°	1100lm	1004379	165,00 EUR	2120lm	1004475	197,00 EUR
		60°	1100lm	1004380	165,00 EUR	2060lm	1004476	197,00 EUR
	2700K	24°	985lm	1004078	115,00 EUR	1925lm	1004174	145,00 EUR
		36°	985lm	1004079	115,00 EUR	1935lm	1004175	145,00 EUR
		60°	980lm	1004080	115,00 EUR	1885lm	1004176	145,00 EUR
	3000K	24°	1020lm	1004086	115,00 EUR	1955lm	1004182	145,00 EUR
		36°	1020lm	1004087	115,00 EUR	1970lm	1004183	145,00 EUR
		60°	1020lm	1004088	115,00 EUR	1880lm	1004184	145,00 EUR
	4000K	24°	1100lm	1004094	115,00 EUR	2125lm	1004190	145,00 EUR
		36°	1100lm	1004095	115,00 EUR	2120lm	1004191	145,00 EUR
		60°	1100lm	1004096	115,00 EUR	2060lm	1004192	145,00 EUR
	2700K	24°	985lm	1004366	165,00 EUR	1925lm	1004462	197,00 EUR
		36°	985lm	1004367	165,00 EUR	1935lm	1004463	197,00 EUR
		60°	980lm	1004368	165,00 EUR	1885lm	1004464	197,00 EUR
	3000K	24°	1020lm	1004374	165,00 EUR	1955lm	1004470	197,00 EUR
		36°	1020lm	1004375	165,00 EUR	1970lm	1004471	197,00 EUR
		60°	1020lm	1004376	165,00 EUR	1880lm	1004472	197,00 EUR
	4000K	24°	1100lm	1004382	165,00 EUR	2125lm	1004478	197,00 EUR
		36°	1100lm	1004383	165,00 EUR	2120lm	1004479	197,00 EUR
		60°	1100lm	1004384	165,00 EUR	2060lm	1004480	197,00 EUR



L 220-240V ~50/60Hz | 700mA
 Potenza assorbita: 28W
 Materiale: alluminio/polycarbonato (PC)

XL 220-240V ~50/60Hz | 900mA
 Potenza assorbita: 36W
 Materiale: alluminio/polycarbonato (PC)

	C	2700K	24°	2440lm	1004266	155,00 EUR	3290lm	1005723	165,00 EUR
			36°	2400lm	1004267	155,00 EUR	3250lm	1005724	165,00 EUR
			60°	2475lm	1004268	155,00 EUR	2980lm	1005725	165,00 EUR
	C	3000K	24°	2430lm	1004274	155,00 EUR	3530lm	1005729	165,00 EUR
			36°	2340lm	1004275	155,00 EUR	3490lm	1005730	165,00 EUR
			60°	2400lm	1004276	155,00 EUR	3210lm	1005731	165,00 EUR
	C	4000K	24°	2675lm	1004282	155,00 EUR	3800lm	1005735	165,00 EUR
			36°	2620lm	1004283	155,00 EUR	3760lm	1005736	165,00 EUR
			60°	2715lm	1004284	155,00 EUR	3460lm	1005737	165,00 EUR
	Dali	2700K	24°	2440lm	1004554	215,00 EUR	3290lm	1005795	235,00 EUR
			36°	2400lm	1004555	215,00 EUR	3250lm	1005796	235,00 EUR
			60°	2475lm	1004556	215,00 EUR	2980lm	1005797	235,00 EUR
	Dali	3000K	24°	2430lm	1004562	215,00 EUR	3530lm	1005801	235,00 EUR
			36°	2340lm	1004563	215,00 EUR	3490lm	1005802	235,00 EUR
			60°	2400lm	1004564	215,00 EUR	3210lm	1005803	235,00 EUR
	Dali	4000K	24°	2675lm	1004570	215,00 EUR	3800lm	1005807	235,00 EUR
			36°	2620lm	1004571	215,00 EUR	3760lm	1005808	235,00 EUR
			60°	2715lm	1004572	215,00 EUR	3460lm	1005809	235,00 EUR
	C	2700K	24°	2440lm	1004270	155,00 EUR	3290lm	1005726	165,00 EUR
			36°	2400lm	1004271	155,00 EUR	3250lm	1005727	165,00 EUR
			60°	2475lm	1004272	155,00 EUR	2980lm	1005728	165,00 EUR
	C	3000K	24°	2430lm	1004278	155,00 EUR	3530lm	1005732	165,00 EUR
			36°	2340lm	1004279	155,00 EUR	3490lm	1005733	165,00 EUR
			60°	2400lm	1004280	155,00 EUR	3210lm	1005734	165,00 EUR
	C	4000K	24°	2675lm	1004286	155,00 EUR	3800lm	1005738	165,00 EUR
			36°	2620lm	1004287	155,00 EUR	3760lm	1005739	165,00 EUR
			60°	2715lm	1004288	155,00 EUR	3460lm	1005740	165,00 EUR
	Dali	2700K	24°	2440lm	1004558	215,00 EUR	3290lm	1005798	235,00 EUR
			36°	2400lm	1004559	215,00 EUR	3250lm	1005799	235,00 EUR
			60°	2475lm	1004560	215,00 EUR	2980lm	1005800	235,00 EUR
	Dali	3000K	24°	2430lm	1004566	215,00 EUR	3530lm	1005804	235,00 EUR
			36°	2340lm	1004567	215,00 EUR	3490lm	1005805	235,00 EUR
			60°	2400lm	1004568	215,00 EUR	3210lm	1005806	235,00 EUR
	Dali	4000K	24°	2675lm	1004574	215,00 EUR	3800lm	1005810	235,00 EUR
			36°	2620lm	1004575	215,00 EUR	3760lm	1005811	235,00 EUR
			60°	2715lm	1004576	215,00 EUR	3460lm	1005812	235,00 EUR

NUMINOS® ZOOM
1006117



short. Smile while you still have teeth.





NUMINOS® ZOOM

Binario trifase



M 220-240V ~50/60Hz | 500mA
 Potenza assorbita: 20W
 Materiale: alluminio/policarbonato (PC)



		2700K	15°-60°	680-1650lm	1006108	183,00 EUR
		3000K	15°-60°	750-1800lm	1006110	183,00 EUR
		4000K	15°-60°	780-1900lm	1006112	183,00 EUR
		2700K	15°-60°	680-1650lm	1006114	232,00 EUR
		3000K	15°-60°	750-1800lm	1006116	232,00 EUR
		4000K	15°-60°	780-1900lm	1006118	232,00 EUR
		2700K	15°-60°	680-1650lm	1006109	183,00 EUR
		3000K	15°-60°	750-1800lm	1006111	183,00 EUR
		4000K	15°-60°	780-1900lm	1006113	183,00 EUR
		2700K	15°-60°	680-1650lm	1006115	232,00 EUR
		3000K	15°-60°	750-1800lm	1006117	232,00 EUR
		4000K	15°-60°	780-1900lm	1006119	232,00 EUR



Apertura del fascio luminoso
 regolabile tra 15° e 60°

Per le dimensioni dettagliate e le informazioni sul montaggio consultare le pagine 118-119

CONFIGURA IL TUO NUMINOS®

SCEGLI

SISTEMA

COLORE

NUMINOS® DL

NUMINOS® MOVE

NUMINOS® GIMBLE

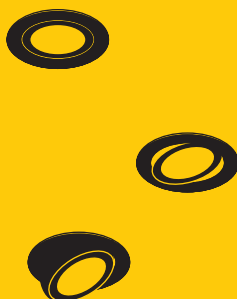

NUMINOS® PROJECTOR

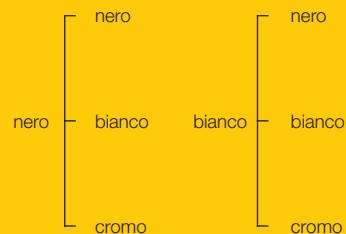

NUMINOS® PD

NUMINOS® CL

NUMINOS® SPOT



NUMINOS® TRACK

NUMINOS® ZOOM



Il sistema NUMINOS® offre caratteristiche di illuminazione omogenee unite a un design moderno per tutte le applicazioni, da hotel e uffici a spazi commerciali e privati. I downlight e gli spot possono essere configurati in modo da soddisfare specifiche esigenze di progettazione a seconda del design o dello spazio in questione. Più articolato sarà il tuo progetto, maggiori saranno i vantaggi che potrai trarre dal sistema di illuminazione NUMINOS®.



Scopri gli apparecchi NUMINOS® per il binario a 48V pag. 468–471

DIMENSIONI

PERFORMANCE

DIFFUSORI

XS **S** **M** **L** **XL**

XS	200mA Potenza assorbita: 7W
S	250mA Potenza assorbita: 8,6W
M	500mA Potenza assorbita: 17,5W
L	700mA Potenza assorbita: 25,4W
XL	1050mA Potenza assorbita: 37,4W

ELLITTICO

Emissione longitudinale della luce, abbagliamento leggermente ridotto, perfetto per l'impiego nei corridoi

PRISMATICO

Fascio di luce più ampio, minore abbagliamento, perfetto per posizionare gli apparecchi a determinate distanze

XS **S** **M** **L**

XS	200mA Potenza assorbita: 7W
S	250mA Potenza assorbita: 8,6W
M	500mA Potenza assorbita: 17,5W
L	700mA Potenza assorbita: 25,4W

SMERIGLIATO

Fascio di luce più ampio, maggiore illuminazione, perfetto per soffitti bassi

A NIDO D'APE

Fascio luminoso stretto, abbagliamento ridotto, perfetto per lavorare al computer

I driver adatti sono disponibili a pag. 94–95

S **M** **L** **XL**

S	250mA Potenza assorbita: 11W
M	500mA Potenza assorbita: 20 W
L	700mA Potenza assorbita: 28W
XL	900mA Potenza assorbita: 36W

S **M** **L** **XL**

NUMINOS® ZOOM disponibile solo nella taglia M

NUMINOS® DIMENSIONI

DOWNLIGHTS

XS

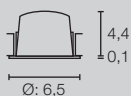

Dimensioni di incasso:
Ø: 5,5 cm P: 11,0 cm

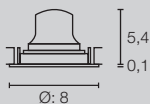

Dimensioni di incasso:
Ø: 6,8 cm P: 8 cm

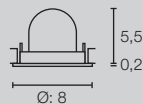

Dimensioni di incasso:
Ø: 6,8 cm P: 8 cm

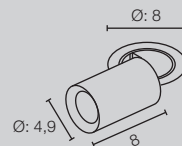

Dimensioni di incasso:
Ø: 6,8 cm P: 10 cm

S

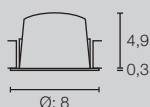

Dimensioni di incasso:
Ø: 6,8 cm P: 5,5 cm

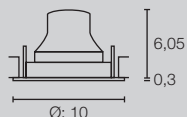

Dimensioni di incasso:
Ø: 9 cm P: 8,5 cm

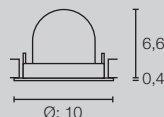

Dimensioni di incasso:
Ø: 9 cm P: 7 cm

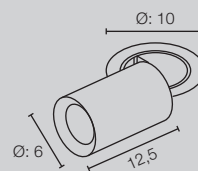

Dimensioni di incasso:
Ø: 8,8 cm P: 15 cm

M

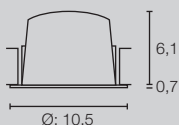

Dimensioni di incasso:
Ø: 9 cm P: 7,5 cm

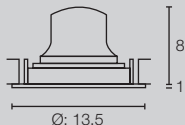

Dimensioni di incasso:
Ø: 12 cm P: 10 cm

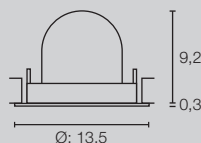

Dimensioni di incasso:
Ø: 12 cm P: 10 cm

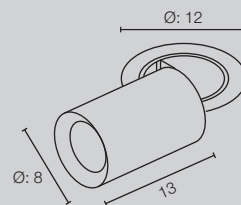

Dimensioni di incasso:
Ø: 10,5 cm P: 15 cm

L

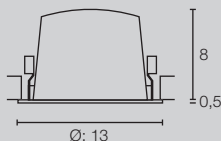

Dimensioni di incasso:
Ø: 11,7 cm P: 9 cm

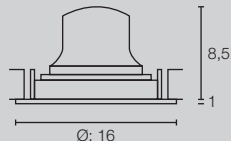

Dimensioni di incasso:
Ø: 14,5 cm P: 10,5 cm

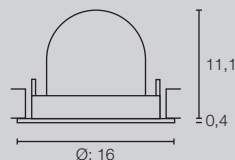

Dimensioni di incasso:
Ø: 14,5 cm P: 11,5 cm

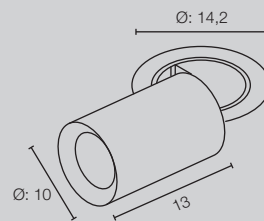

Dimensioni di incasso:
Ø: 13 cm P: 15 cm

XL

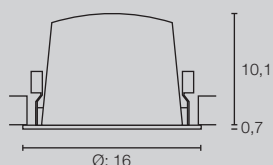

Dimensioni di incasso:
Ø: 14,5 cm P: 11,5 cm

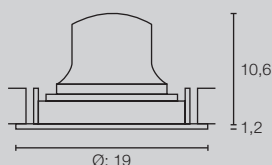

Dimensioni di incasso:
Ø: 17,5 cm P: 13 cm

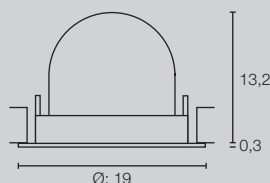

Dimensioni di incasso:
Ø: 17,5 cm P: 13,5 cm

**NUMINOS®
DL**

**NUMINOS®
MOVE**

**NUMINOS®
GIMBLE**

**NUMINOS®
PROJECTOR**

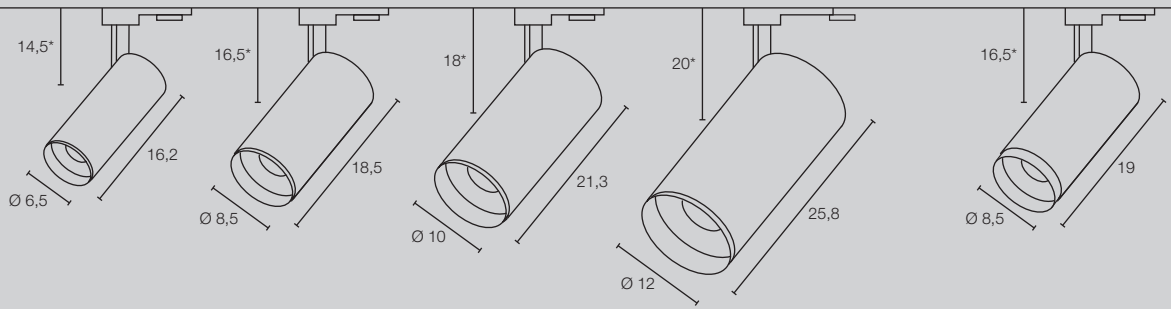
S**M****L****XL****M****NUMINOS® TRACK**

*Con angolo inferiore a 90°

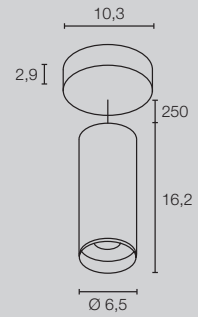
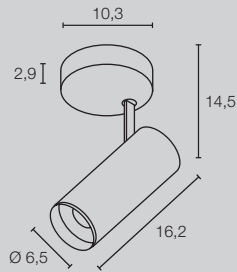
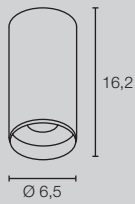
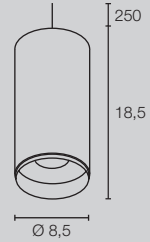
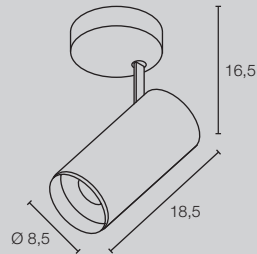
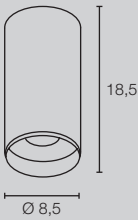
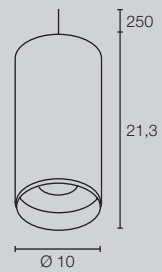
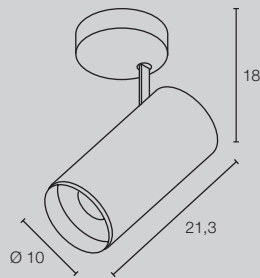
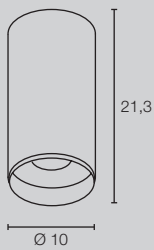
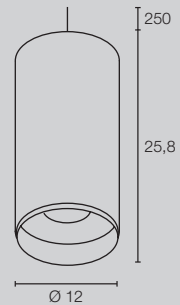
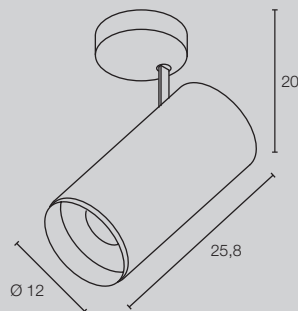
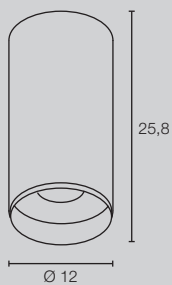
NUMINOS® ZOOM**LAMPADE DA PARETE E A PLAFONE****S****M****L****XL****NUMINOS®
CL****NUMINOS®
CW****NUMINOS®
PD**

NUMINOS®

DOWN-/SPOTLIGHTS



Scopri il configuratore
NUMINOS® su
slv.com

Disponibili in sette versioni con
modulo LED a elevate presta-
zioni in tre temperature di colore
e gradi di abbagliamento.

Riflettori a scelta con apertura del
fascio luminoso di 20°, 40° e 55°

Vari filtri disponibili
come accessori.

Anello decorativo in tre finiture

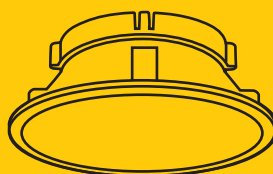
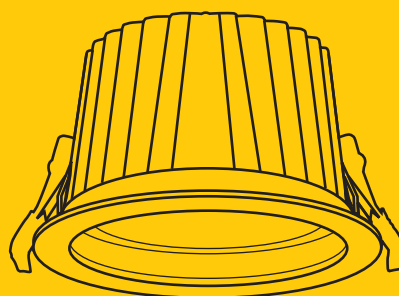

DOWNLIGHTS

I downlight NUMINOS® sono disponibili nella versione fissa oppure orientabile.

NUMINOS® UN SISTEMA, INFINITE POSSIBILITÀ. Il sistema di illuminazione configurabile che dona la luce migliore ad ogni ambiente. Ogni progetto è unico. Tuttavia, molti progetti richiedono illuminazione e design omogenei. NUMINOS® è un sistema di apparecchi perfettamente coordinati tra loro che armonizzano funzionalità, design e tecnologia. Per progettisti e installatori. Per qualsiasi esigenza. Per la massima versatilità con il minimo sforzo.

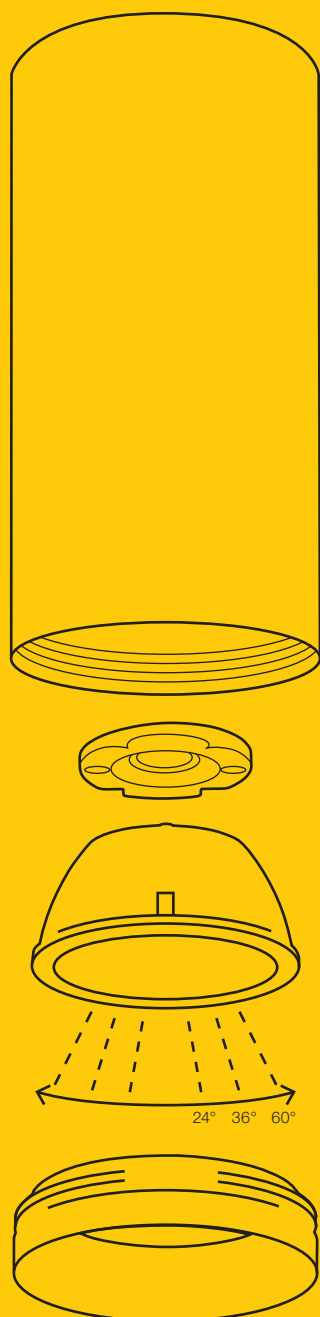

Disponibile in tre formati con modulo LED ad alte prestazioni e due temperature del colore.

Grazie al driver LED incorporato, tutti gli spot sono predisposti alla connessione diretta alla tensione di rete 230V.

Lenti a scelta con apertura del fascio luminoso tra 24°, 36° e 60°.

Anello decorativo disponibile anche bianco come accessorio.

SPOTLIGHTS

I faretto NUMINOS® sono disponibili a parete e a plafone, orientabili o fissi, a sospensione e in versione spot per binari trifase e 48V.

NEW TRIA®
1007334

COMBINA



i portalampada GU10
o i moduli LED

+



Cornice da incasso nei
colori nero, bianco,
oro satinato, alluminio

=



NEW TRIA® Downlight (DL)



NEW



Sistema modulare plug & play
per la massima flessibilità



Straordinaria resa
cromatica >90



Versione
IP65

Facile da installare grazie
al connettore rapido



SET NEW TRIA®

*Troverai set già combinati dei nostri prodotti più venduti
alle pagine 132-139*

MODULI LED PER cornici con diametro di incasso 68 E 75 mm

NEW

NEW TRIA® DL, Modulo LED, Phase



220-240V ~50/60Hz
Materiale: alluminio

	IP20	200mA	8,3W	2700K	705lm	1007381	45,00 EUR
				3000K	750lm	1007383	45,00 EUR



NEW TRIA® DL, Modulo LED, Phase



220-240V ~50/60Hz
Materiale: alluminio

	IP20	200mA	8,3W	2700K	705lm	1007382	45,00 EUR
				3000K	750lm	1007384	45,00 EUR



MODULI LED DIM-TO-WARM PER CORNICI CON DIAMETRO DI INCASSO 68 E 75 mm

NEW TRIA® DL, Modulo LED, DTW, Phase



220-240V ~50/60Hz
Materiale: alluminio

	IP20	250mA	11W	1800 - 3000K	700lm	1007421	56,00 EUR
--	------	-------	-----	--------------	-------	---------	-----------



NEW TRIA® DL, Modulo LED, DTW, Phase



220-240V ~50/60Hz
Materiale: alluminio

	IP20	250mA	11W	1800 - 3000 K	700lm	1007422	56,00 EUR
--	------	-------	-----	---------------	-------	---------	-----------



DIM-TO-WARM (DTW)

Con la funzione dim-to-warm è possibile regolare la temperatura del colore e la luminosità degli apparecchi. In questo modo, la luce passa da luminosa e fredda a morbida e calda quando viene attenuata.

Tutti i dati espressi in watts si riferiscono alla potenza del sistema.

Per le dimensioni dettagliate e le informazioni sul montaggio consultare le pagine 128-129

MODULI LED MULTI POTENZA E COLORE CCT PER CORNICI CON DIAMETRO DI INCASSO 68 E 75 mm

NEW TRIA® UNIVERSAL DL, Modulo LED, Phase



220-240V ~50/60Hz
Materiale: alluminio

● IP20 100 - 180mA 4,6 - 8,6W CCT 2500 / 3000 / 4000K 540 / 600 / 600lm 1007431 ● 76,00 EUR



NEW TRIA® UNIVERSAL DL, Modulo LED, Phase



220-240V ~50/60Hz
Materiale: alluminio

● IP20 100 - 180mA 4,6 - 8,6W CCT 2500 / 3000 / 4000K 540 / 600 / 600lm 1007432 ● 76,00 EUR



MODULI GU10 PER CORNICI CON DIAMETRO DI INCASSO 68 E 75 mm

GU10 LED CONNECTION BOX Attacco GU10 con box per installazione rapida



220-240V ~50/60Hz
Materiale: alluminio

● - IP20 - <10W - - 1007283 ● 6,00 EUR

Sorgenti luminose adatte disponibili a pagina 860



MODULI LED PER CORNICI CON DIAMETRO DI INCASSO 95 mm

NEW TRIA® DL, Modulo LED, Phase



220-240V ~50/60Hz
Materiale: alluminio

● IP20 350mA 13,3W 2700K 1130lm 1007409 ● 95,00 EUR
● 3000K 1200lm 1007410 ● 95,00 EUR



NEW TRIA® DL, Modulo LED, Phase



220-240V ~50/60Hz
Materiale: alluminio

● IP20 350mA 13,3W 2700K 1130lm 1007411 ● 95,00 EUR
● 3000K 1200lm 1007412 ● 95,00 EUR















SCEGLI LA TUA CORNICE DA INCASSO:



NEW



Compatibili con tutti i moduli diametro 68/75

	nero			1007332	14,90 EUR	
NEW TRIA® 68 <i>Rotondo, modulo GU10/LED</i>	bianco	IP20	Ø: 8,2 cm, H: 2,6 cm	1007333	14,90 EUR	
	oro satinato			1007334	24,90 EUR	
	alluminio			1007335	19,90 EUR	
	nero			1007329	14,90 EUR	
NEW TRIA® 68 <i>Quadrato, modulo GU10/LED</i>	bianco	IP20	L: 8,2 cm, La: 8,2 cm, H: 2,6 cm	1007328	14,90 EUR	
	oro satinato			1007331	24,90 EUR	
	alluminio			1007330	19,90 EUR	
	nero			1007451	15,90 EUR	
NEW TRIA® 68 <i>Rotondo, modulo GU10/LED</i>	bianco	IP20	Ø: 8,2 cm, H: 4,4 cm	1007453	15,90 EUR	
	nero			1007345	24,90 EUR	
NEW TRIA® 68 <i>Rotondo, modulo GU10/LED</i>	bianco	IP65	Ø: 8,2 cm, H: 3,4 cm	1007346	24,90 EUR	
	nero			1007347	24,90 EUR	
NEW TRIA® 68 <i>Quadrato, modulo GU10/LED</i>	bianco	IP65	L: 8,2 cm, La: 8,2 cm, H: 3,4 cm	1007348	24,90 EUR	
	nero			1007336	35,90 EUR	
NEW TRIA® 68 <i>Rotondo, moduli Led/GU10 con vetro decorativo</i>	bianco	IP65	Ø: 8,3 cm, H: 3,6 cm	1007337	35,90 EUR	
	nero			1007338	35,90 EUR	
NEW TRIA® 68 <i>Quadrato, moduli Led/GU10 con vetro decorativo</i>	bianco	IP65	L: 8,3 cm, La: 8,3 cm, H: 3,6 cm	1007339	35,90 EUR	
	nero			1007343	19,90 EUR	
NEW TRIA® 75 <i>Rotondo, modulo GU10/LED</i>	bianco	IP20	Ø: 9,3 cm, H: 2,6 cm	1007342	19,90 EUR	
	oro satinato			1007344	28,90 EUR	
	alluminio			1007351	23,90 EUR	
	nero			1007340	19,90 EUR	
NEW TRIA® 75 <i>Quadrato, modulo GU10/LED</i>	bianco	IP20	L: 9 cm, La: 9 cm, H: 2,6 cm	1007349	19,90 EUR	
	oro satinato			1007341	28,90 EUR	
	alluminio			1007350	23,90 EUR	
	nero			1007449	18,90 EUR	
NEW TRIA® 75 <i>Rotondo, modulo GU10/LED Rientrato con bordo sporgente</i>	bianco	IP20	Ø: 8,2 cm, H: 4,9 cm	1007450	18,90 EUR	
	nero			1007488	14,90 EUR	
NEW TRIA® 75 <i>Rotondo, modulo GU10/LED Rientrato</i>	bianco	IP20	Ø: 8,2 cm, H: 4,3 cm	1007489	14,90 EUR	
	nero			1007631	24,90 EUR	
NEW TRIA® 75 XL <i>Rotondo, modulo GU10/LED</i>	bianco	IP20	Ø: 11 cm, H: 2,6 cm	1007630	24,90 EUR	
	oro satinato			1007633	33,90 EUR	
	alluminio			1007632	28,90 EUR	
	nero			1007635	24,90 EUR	
NEW TRIA® 75 XL <i>Quadrato, modulo GU10/LED</i>	bianco	IP20	L: 11 cm, La: 11 cm, H: 2,6 cm	1007634	24,90 EUR	
	oro satinato			1007637	33,90 EUR	
	alluminio			1007636	28,90 EUR	
	nero			1007444	29,90 EUR	

COMPATIBILI CON TUTTI I MODULI DIAMETRO 95

	nero			1007444	29,90 EUR	
NEW TRIA® 95 <i>Rotondo, moduli LED</i>	bianco	IP20	Ø: 11 cm, H: 2,6 cm	1007443	29,90 EUR	
	oro satinato			1007447	39,90 EUR	
	alluminio			1007445	34,90 EUR	
	nero			1007452	29,90 EUR	
NEW TRIA® 95 <i>Rotondo, moduli LED</i>	bianco	IP20	Ø: 10,3 cm, H: 5,5 cm	1007454	29,90 EUR	
	nero			1007446	29,90 EUR	
NEW TRIA® 95 <i>Quadrato, moduli LED</i>	bianco	IP20	L: 11 cm, La: 11 cm, H: 2,6 cm	1007448	29,90 EUR	
	nero					



Con vetro
decorativo



Orientabile
di 30°

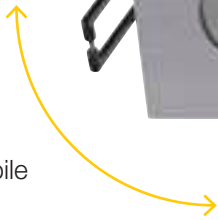

Ruotabile
e orientabile
di 30°

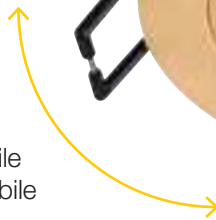

Rientrato
con bordo
sporgente



Rientrato

NEW TRIA® DIMENSIONI

MODULI LED E GU10 PER CORNICI CON DIAMETRO DI INCASSO 68/75 mm

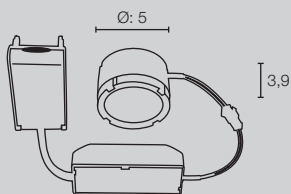

1007381 - 384

NEW TRIA®
DL, MODULO LED, PHASE

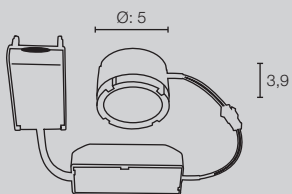

1007421 - 422

NEW TRIA®
DL, MODULO LED, DTW, PHASE

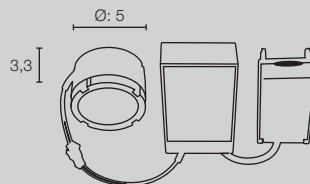

1007431 - 432

NEW TRIA® UNIVERSAL
DL, MODULO LED, PHASE

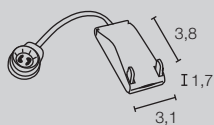

1007283

GU10 LED CONNECTION BOX
ATTACCO GU10 CON BOX PER INSTALLAZIONE RAPIDA

MODULI LED PER CORNICI CON
DIAMETRO DI INCASSO 95 mm

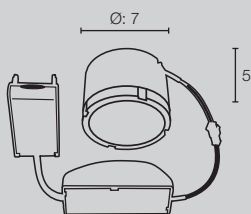

1007409, 1007410 - 412

NEW TRIA®
DL, MODULO LED, PHASE

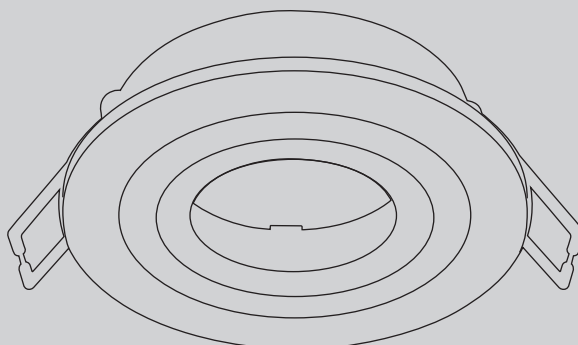
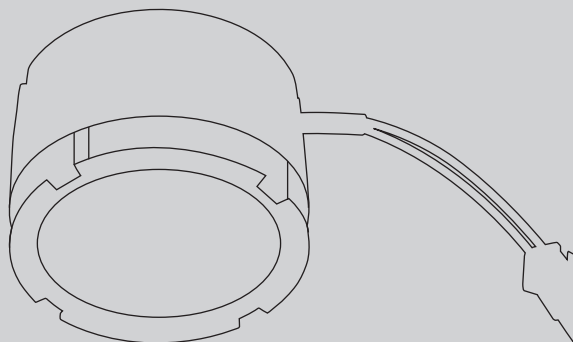

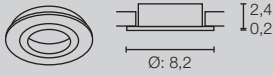

Diam di incasso: Ø: 6,8 cm
1007332 - 335

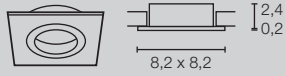

Diametro di incasso: Ø: 6,8 cm
1007328 - 331

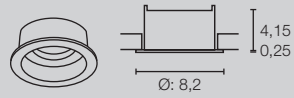

Diametro di incasso: Ø: 6,8 cm
1007451, 1007453

NEW TRIA® 68
RING, ROTONDO, MODULI GU10/LED

NEW TRIA® 68
RING, QUADRATO, MODULI GU10/LED

NEW TRIA® 68
RING, ROTONDO, MODULI GU10/LED

Versione
IP65

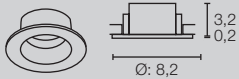

Diametro di incasso: Ø: 6,8 cm
1007345 - 346

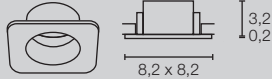

Diametro di incasso: Ø: 6,8 cm
1007347 - 348

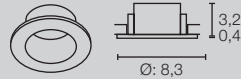

Diametro di incasso: Ø: 6,8 cm
1007336 - 337

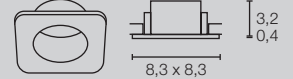

Diametro di incasso: Ø: 6,8 cm
1007338 - 339

NEW TRIA® 68
RING, ROTONDO, MODULI GU10/LED

NEW TRIA® 68
RING, QUADRATO, MODULI GU10/LED

NEW TRIA® 68
RING, ROTONDO, MODULI GU10/LED

NEW TRIA® 68
RING, QUADRATO, MODULI GU10/LED

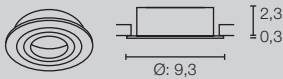

Diametro di incasso: Ø: 7,5 cm
1007342 - 344, 1007351

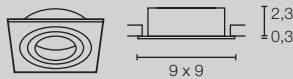

Diametro di incasso: Ø: 7,5 cm
1007340 - 341, 1007349 - 350

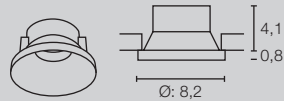

Diametro di incasso: Ø: 7,5 cm
1007449 - 450

NEW TRIA® 75
RING, ROTONDO, MODULI GU10/LED

NEW TRIA® 75
RING, QUADRATO, MODULI GU10/LED

NEW TRIA® 75
RING, ROTONDO, MODULI GU10/LED

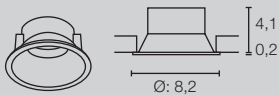

Diametro di incasso: Ø: 7,5 cm
1007488 - 489

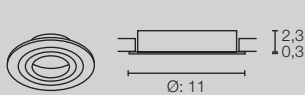

Diametro di incasso: Ø: 7,5 cm
1007630 - 633

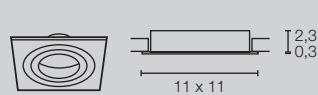

Diametro di incasso: Ø: 7,5 cm
1007634 - 637

NEW TRIA® 75
RING, ROTONDO, MODULI GU10/LED

NEW TRIA® 75 XL
RING, ROTONDO, MODULI GU10/LED

NEW TRIA® 75 XL
RING, QUADRATO, MODULI GU10/LED

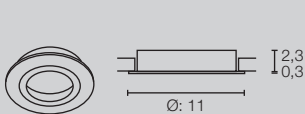

Diametro di incasso: Ø: 9,5 cm
1007443 - 445, 1007447

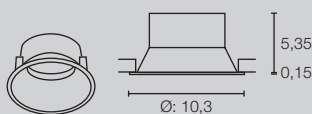

Diametro di incasso: Ø: 9,5 cm
1007452, 1007454

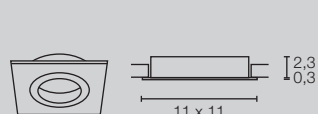

Diametro di incasso: Ø: 9,5 cm
1007446, 1007448

NEW TRIA® 95
RING, ROTONDO, MODULI LED

NEW TRIA® 95
RING, ROTONDO, MODULI LED

NEW TRIA® 95
RING, QUADRATO, MODULI LED

CONFIGURA IL TUO NEW TRIA®

Più modularità per una maggiore flessibilità con i downlight della serie NEW TRIA®, la serie dona una nuova luce a versatilità e design. Sarà sufficiente scegliere le opzioni giuste e beneficiare di un'installazione rapida.

SCEGLI LA CORNICE DA INCASSO A TUO PIACIMENTO:

- 1 Utilizzo [*orientabile, orientabile e girevole, IP65*
Diametro foro di 68, 75 e 95 mm
- 2 Colore *nero, bianco, oro satinato o alluminio*
- 3 *rotonda o quadrata*

ABBINA IL MODULO CHE PREFERISCI:

- 1 *da 68/75 o 95 mm*
- 2 *Temperatura del colore*
2700K o 3000K, 1800-3000K o CCT 2500 / 3000 / 4000K
- 3 *Angolo di emissione*
38° / 60°

FATTO!

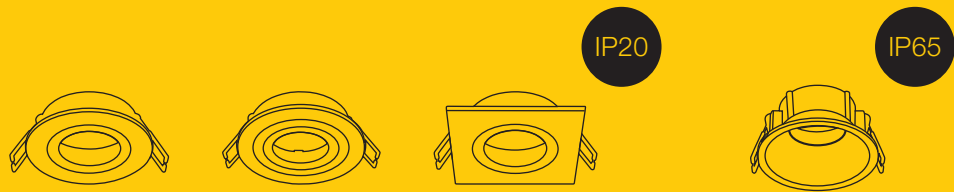

Cornice da incasso



Disponibile in versione orientabile, orientabile e girevole o IP65 con diametro di installazione di 68, 75 e 95 mm



Nei colori nero, bianco, oro satinato o alluminio



Forma rotonda o quadrata

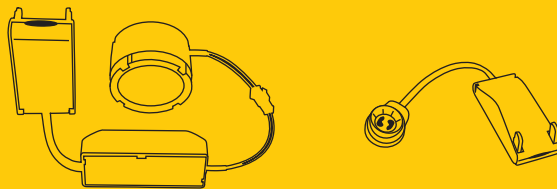

MODULO LED

GU10

NEW TRIA® 68

NEW TRIA® 75

NEW TRIA® 95



Temperatura del colore
2700 / 3000K, DTW 1800 - 3000K o multi



Angolo di emissione
38° / 60°

NEW TRIA® 68
1007388





NEW TRIA® Downlight (DL)



NEW

Versione
GU10NEW TRIA® 75
DL, rotonda, QPAR51NEW TRIA® 68
DL, rotonda, PhaseVersione
IP65NEW TRIA® 68
DL, quadrata, PhaseNEW TRIA® 75
DL, quadrata, QPAR51Versione
DTWNEW TRIA® 68
DL, rotondo, DTW, Phase

SET NEW TRIA®

Tutti i set NEW TRIA® includono componenti perfettamente abbinati per un'installazione rapida e semplice. Con la versione dim-to-warm, multi CCT o GU10, i set NEW TRIA® offrono la soluzione migliore.

SET COMPLETI (CORNICE DA INCASSO + MODULO LED)



NEW TRIA® 68 DL, rotondo, Phase



220-240V ~50/60Hz
Materiale: alluminio

		IP20	200mA	8,3W	2700K	705lm	1007386 ●	54,00 EUR
							1007385 ●	54,00 EUR
		IP20	200mA	8,3W	3000K	750lm	1007390 ●	54,00 EUR
							1007389 ●	54,00 EUR



NEW TRIA® 68 DL, rotondo, Phase



220-240V ~50/60Hz
Materiale: alluminio

		IP20	200mA	8,3W	2700K	705lm	1007388 ●	54,00 EUR
							1007387 ●	54,00 EUR
		IP20	200mA	8,3W	3000K	750lm	1007392 ●	54,00 EUR
							1007391 ●	54,00 EUR



NEW TRIA® 68 DL, quadrato, Phase



220-240V ~50/60Hz
Materiale: alluminio

		IP20	200mA	8,3W	2700K	705lm	1007394 ●	54,00 EUR
							1007393 ●	54,00 EUR
		IP20	200mA	8,3W	3000K	750lm	1007398 ●	54,00 EUR
							1007397 ●	54,00 EUR



NEW TRIA® 68 DL, quadrato, Phase



220-240V ~50/60Hz
Materiale: alluminio

		IP20	200mA	8,3W	2700K	705lm	1007396 ●	54,00 EUR
							1007395 ●	54,00 EUR
		IP20	200mA	8,3W	3000K	750lm	1007400 ●	54,00 EUR
							1007399 ●	54,00 EUR



Tutti i dati espressi in watts si riferiscono alla potenza del sistema.

Per le dimensioni dettagliate e le informazioni sul montaggio consultare le pagine 146-147



NEW TRIA® 68 DL, rotondo, Phase

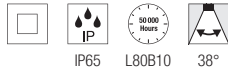

220-240V ~50/60Hz
Materiale: alluminio

		IP65	200mA	8,3W	2700K	460lm	1007406 ●	69,00 EUR	
		IP65	200mA	8,3W	3000K	530lm	1007405 ●	69,00 EUR	
		IP65	200mA	8,3W	3000K	500lm	1007408 ●	69,00 EUR	
		IP65	200mA	8,3W	3000K	570lm	1007407 ●	69,00 EUR	

DIM-TO-WARM



NEW TRIA® 68 DL, rotondo, DTW, Phase



220-240V ~50/60Hz
Materiale: alluminio

		IP20	250mA	11W	1800 - 3000K	700lm	1007424 ●	69,00 EUR	
		IP20	250mA	11W	1800 - 3000K	700lm	1007423 ●	69,00 EUR	

NEW TRIA® 68 DL, rotondo, DTW, Phase



220-240V ~50/60Hz
Materiale: alluminio

		IP20	250mA	11W	1800 - 3000K	700lm	1007426 ●	69,00 EUR	
		IP20	250mA	11W	1800 - 3000K	700lm	1007425 ●	69,00 EUR	

NEW TRIA® 68 DL, quadrato, DTW, Phase



220-240V ~50/60Hz
Materiale: alluminio

		IP20	250mA	11W	1800 - 3000K	700lm	1007428 ●	69,00 EUR	
		IP20	250mA	11W	1800 - 3000K	700lm	1007427 ●	69,00 EUR	

NEW TRIA® 68 DL, quadrato, DTW, Phase



220-240V ~50/60Hz
Materiale: alluminio

		IP20	250mA	11W	1800 - 3000K	700lm	1007430 ●	69,00 EUR	
		IP20	250mA	11W	1800 - 3000K	700lm	1007429 ●	69,00 EUR	



Temperatura del colore CCT / Multi potenza

NEW TRIA® UNIVERSAL 68 DL, rotondo, Phase



220-240V ~50/60Hz
Materiale: alluminio

  IP20 100 - 180mA 4,6 - 8,6W CCT 2500 / 3000 / 4000K 540 / 600 / 600lm

1007434 ● 89,00 EUR
1007433 ● 89,00 EUR



NEW TRIA® UNIVERSAL 68 DL, rotondo, Phase



220-240V ~50/60Hz
Materiale: alluminio

  IP20 100 - 180mA 4,6 - 8,6W CCT 2500 / 3000 / 4000K 540 / 600 / 600lm

1007436 ● 89,00 EUR
1007435 ● 89,00 EUR



NEW TRIA® UNIVERSAL 68 DL, quadrato, Phase



220-240V ~50/60Hz
Materiale: alluminio

  IP20 100 - 180mA 4,6 - 8,6W CCT 2500 / 3000 / 4000K 540 / 600 / 600lm

1007438 ● 89,00 EUR
1007437 ● 89,00 EUR





NEW TRIA® UNIVERSAL 68 DL, quadrato, Phase



220-240V ~50/60Hz
Materiale: alluminio

		IP20	100 - 180mA	4,6 - 8,6W	CCT 2500 / 3000 / 4000K	540 / 600 / 600lm	1007440 ● 89,00 EUR
							1007439 ● 89,00 EUR



NEW TRIA® UNIVERSAL 68 DL, rotondo, Phase



Versione
IP65

220-240V ~50/60Hz
Materiale: alluminio

		IP65	100 - 180mA	4,6 - 8,6W	CCT 2500 / 3000 / 4000K	370 / 410 / 410lm	1007442 ● 99,00 EUR
						430 / 470 / 470lm	1007441 ● 99,00 EUR



NEW TRIA® 75 DL, rotondo, Phase



220-240V ~50/60Hz
Materiale: alluminio

		IP20	200mA	8,3W	2700K	705lm	1007402 ● 64,00 EUR
							1007401 ● 64,00 EUR
		IP20	200mA	8,3W	3000K	750lm	1007404 ● 64,00 EUR
							1007403 ● 64,00 EUR



Tutti i dati espressi in watts si riferiscono alla potenza del sistema.

Per le dimensioni dettagliate e le informazioni sul montaggio consultare le pagine 146-147

Set completi (cornice da incasso + attacco GU10)



NEW TRIA® 68 DL, rotondo, QPAR51



220-240V ~50/60Hz
Materiale: alluminio



- IP20 - <10W 1xGU10 -

1007369 ● 19,90 EUR
1007368 ● 19,90 EUR
1007370 ● 25,90 EUR



NEW TRIA® 68 DL, quadrato, QPAR51

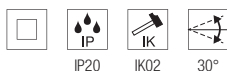

220-240V ~50/60Hz
Materiale: alluminio



- IP20 - <10W 1xGU10 -

1007372 ● 19,90 EUR
1007371 ● 19,90 EUR
1007373 ● 25,90 EUR



NEW TRIA® 75 DL, rotondo, QPAR51



220-240V ~50/60Hz
Materiale: alluminio



- IP20 - <10W 1xGU10 -

1007375 ● 25,90 EUR
1007374 ● 25,90 EUR
1007376 ● 29,90 EUR



NEW TRIA® 75 DL, quadrato, QPAR51

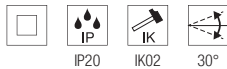

220-240V ~50/60Hz
Materiale: alluminio



- IP20 - <10W 1xGU10 -

1007378 ● 25,90 EUR
1007377 ● 25,90 EUR
1007379 ● 29,90 EUR





NEW TRIA® 75 XL DL, rotondo, QPAR51

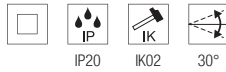

220-240V ~50/60Hz
Materiale: alluminio



IP20

-

<10W

1xGU10

-

1007625 ● 30,90 EUR

1007624 ● 30,90 EUR

1007626 ● 34,90 EUR



NEW TRIA® 75 XL DL, quadrato, QPAR51



220-240V ~50/60Hz
Materiale: alluminio



IP20

-

<10W

1xGU10

-

1007628 ● 30,90 EUR

1007627 ● 30,90 EUR

1007629 ● 34,90 EUR



LED GU10
38°, Classe=F, 6kWh/1000h



6W

2700K

450lm

51 mm

1005077

7,50 EUR



NEW TRIA®
113890

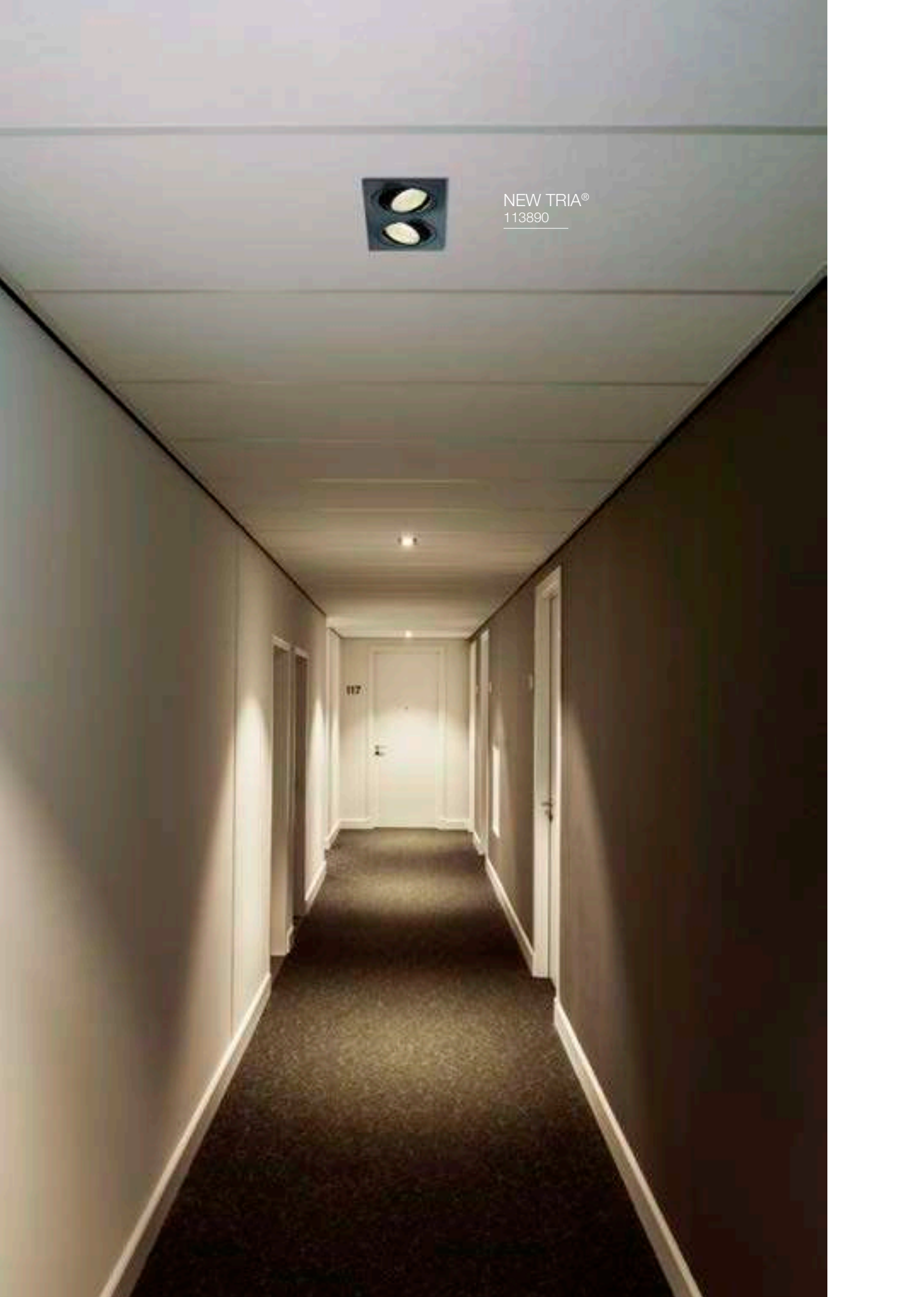



NEW TRIA®
Downlight (DL)



NEW TRIA® 155
DL, Double



NEW TRIA® 45
DL, rotondo

NEW TRIA® 45
DL, rotondo



220-240V ~50/60Hz
Materiale: alluminio

●	-	IP44	700mA	3,4W	3000K	190lm	113970	53,00 EUR
○	-	IP44	700mA	3,4W	3000K	190lm	113971	53,00 EUR
●	-	IP44	700mA	3,4W	3000K	190lm	113976	60,00 EUR



NEW TRIA® 155
DL, Double

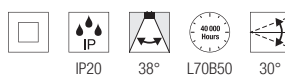

220-240V ~50/60Hz
Materiale: alluminio

●	-	IP20	350mA	14W	2700K	1160lm	113890	115,00 EUR
○	-	IP20	350mA	14W	2700K	1160lm	113891	115,00 EUR



Per le dimensioni dettagliate e le informazioni sul montaggio consultare le pagine 146-147

NEW TRIA®
113550



NEW TRIA® Downlight (DL)

**SOCKET
INSIDE**

NEW TRIA® 150
DL, rotondo



NEW TRIA® 150
DL, quadrato



NEW TRIA® 155
DL, Double



NEW TRIA® 300
DL, Double



NEW TRIA®
113840

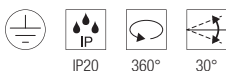

**NEW TRIA® 150**
DL, rotondo, QPAR111220-240V ~50/60Hz
Materiale: alluminio

	-	IP20	-	<75W	1xGU10	-	113550	52,00 EUR
							113540	52,00 EUR

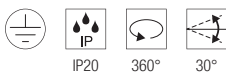
**NEW TRIA® 150**
DL, quadrato, QPAR111220-240V ~50/60Hz
Materiale: alluminio

	-	IP20	-	<75W	1xGU10	-	113830	52,00 EUR
							113541	52,00 EUR

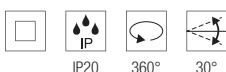
**NEW TRIA® 155**
DL, Double, QPAR51220-240V ~50/60Hz
Materiale: alluminio

	-	IP20	-	<50W	2xGU10	-	113492	50,00 EUR
							113512	50,00 EUR
							111362	53,00 EUR

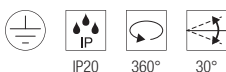
**NEW TRIA® 300**
DL, Double, QPAR111220-240V ~50/60Hz
Materiale: alluminio

	-	IP20	-	<75W	2xGU10	-	113840	104,00 EUR
							113841	104,00 EUR
							111382	115,00 EUR



LED GU10 38°, Classe=F, 6kWh/1000h Per NEW TRIA® 155		6W	2700K	450lm	51 mm	1005077	7,50 EUR
QPAR111 38°, Classe=F, 8kWh/1000h Per NEW TRIA® 150/300		8W	2700K	680lm	-	1005274	30,75 EUR
LED GU10 40°, Classe=G, 8kWh/1000h Per NEW TRIA® 150/300		7,3W	2700K	500lm	111 mm	1005294	24,50 EUR
QPAR111 30°, Classe=F, 13kWh/1000h Per NEW TRIA® 150/300		12,5W	2700K	950lm	-	1005276	49,50 EUR

NEW TRIA® DIMENSIONI

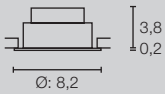

Dimensioni di incasso:
Ø: 6,8 cm P: 4 cm

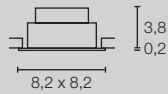

Dimensioni di incasso:
Ø: 6,8 cm P: 4 cm

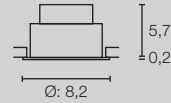

Dimensioni di incasso:
Ø: 6,8 cm P: 6 cm

Versione
IP65

NEW TRIA® 68
DL, ROTONDO, PHASE

NEW TRIA® 68
DL, QUADRATO, PHASE

NEW TRIA® 68
DL, ROTONDO, PHASE

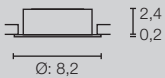

Dimensioni di incasso:
Ø: 6,8 cm P: 6,5 cm

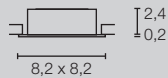

Dimensioni di incasso:
Ø: 6,8 cm P: 6,5 cm

NEW TRIA® 68
DL, ROTONDO, QPAR51

NEW TRIA® 68
DL, QUADRATO, QPAR51

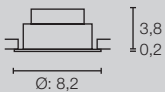

Dimensioni di incasso:
Ø: 6,8 cm P: 4,5 cm

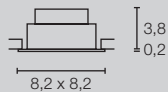

Dimensioni di incasso:
Ø: 6,8 cm P: 4,5 cm

NEW TRIA® 68
DL, ROTONDO, DTW, PHASE

NEW TRIA® 68
DL, QUADRATO, DTW, PHASE

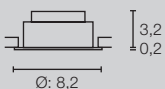

Dimensioni di incasso:
Ø: 6,8 cm P: 4 cm

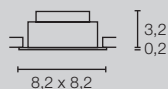

Dimensioni di incasso:
Ø: 6,8 cm P: 4 cm

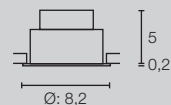

Dimensioni di incasso:
Ø: 6,8 cm P: 5,5 cm

Versione
IP65

NEW TRIA® UNIVERSAL 68
DL, ROTONDO, PHASE

NEW TRIA® UNIVERSAL 68
DL, QUADRATO, PHASE

NEW TRIA® UNIVERSAL 68
DL, ROTONDO, PHASE

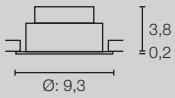

Dimensioni di incasso:
 \varnothing : 7,5 cm P: 4 cm

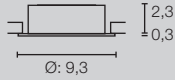

Dimensioni di incasso:
 \varnothing : 7,5 cm P: 6,5 cm

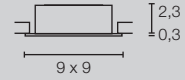

Dimensioni di incasso:
 \varnothing : 7,5 cm P: 6,5 cm

NEW TRIA® 75
 DL, ROTONDO, PHASE

NEW TRIA® 75
 DL, ROTONDO, QPAR51

NEW TRIA® 75
 DL, QUADRATO, QPAR51

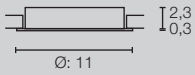

Dimensioni di incasso:
 \varnothing : 7,5 cm P: 6,5 cm

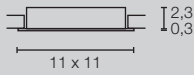

Dimensioni di incasso:
 \varnothing : 7,5 cm P: 6,5 cm

NEW TRIA® 75 XL
 DL, ROTONDO, QPAR51

NEW TRIA® 75 XL
 DL, QUADRATO, QPAR51

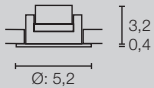

Dimensioni di incasso:
 \varnothing : 4,5 cm P: 4 cm

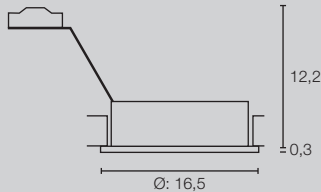

Dimensioni di incasso:
 \varnothing : 15 cm P: 12,5 cm

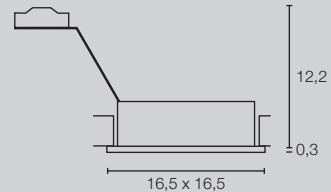

Dimensioni di incasso:
 \varnothing : 15 cm P: 12,5 cm

NEW TRIA® 45
 DL, ROTONDO

NEW TRIA® 150
 DL, ROTONDO, QPAR111

NEW TRIA® 150
 DL, QUADRATO, QPAR111

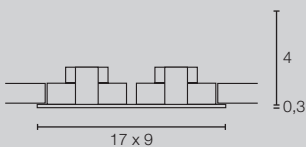

Dimensioni di incasso:
 L: 15,5, La: 8 cm P: 4 cm

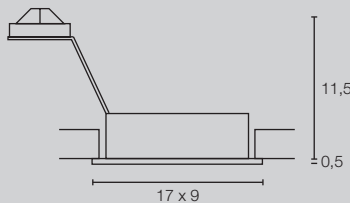

Dimensioni di incasso:
 L: 15 cm, La: 7,8 cm, P: 12,5 cm

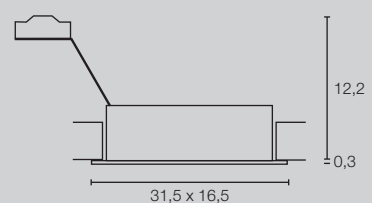

Dimensioni di incasso:
 L: 30 cm, La: 15,5 cm, P: 12,5 cm

NEW TRIA® 155
 DL, DOUBLE

NEW TRIA® 155
 DL, DOUBLE, QPAR51

NEW TRIA® 300
 DL, DOUBLE, QPAR111

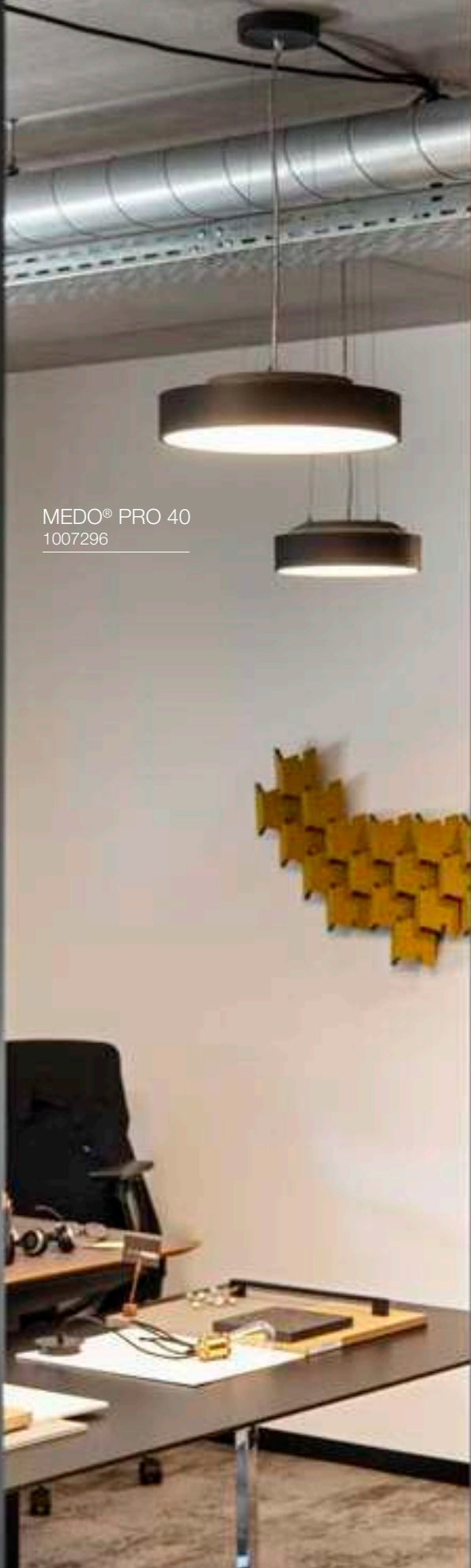

MEDO® PRO 40
1007296

Scopri la famiglia MEDO®
al completo

NEW



MEDO® PRO CW



MEDO® PRO (DC) CW



MEDO® CW



MEDO® CL



MEDO® RING PD



MEDO® EL

MEDO® PRO

Lampade da parete e a plafone (CW)



NEW

Set per sospensione escluso

Disponibile anche con
diffusore prismatico anti
abbagliamento UGR<19

Straordinaria resa cromatica
CRI>90

Selezione della temperatura
del colore tramite interruttore
CCT (3000/4000K)

Il retro trasparente garantisce
una diffusione ottimale della
luce indiretta



Installazione facile
e rapida grazie
a EasyBase

ILLUMINAZIONE SUGGESTIVA

*Le nuove versioni MEDO®,
grazie alla componente di luce
indiretta, fanno risplendere
anche lo sfondo. In questo
modo si ottiene un'illuminazione
piacevole, omogenea e non
abbagliante degli ambienti.*

DIFFUSORE PRISMATIZZATO (UGR<19)

MEDO® PRO 30 CW, DALI, UGR<19



220-240V ~50/60Hz
Materiale: alluminio/polistirene (PS)

		IP50	250mA	10W	CCT 3000 / 4000K	1250 / 1250lm	1007284 ● 329,00 EUR	
							1007285 ● 329,00 EUR	

MEDO® PRO 30 CW, Phase, UGR<19



220-240V ~50/60Hz
Materiale: alluminio/polistirene (PS)

		IP50	250mA	10W	CCT 3000 / 4000K	1250 / 1250lm	1007288 ● 299,00 EUR	
							1007289 ● 299,00 EUR	

MEDO® PRO 40 CW, DALI, UGR<19



220-240V ~50/60Hz
Materiale: alluminio/polistirene (PS)

		IP50	500mA	19W	CCT 3000 / 4000K	2400 / 2500lm	1007292 ● 449,00 EUR	
							1007293 ● 449,00 EUR	

MEDO® PRO 40 CW, Phase, UGR<19



220-240V ~50/60Hz
Materiale: alluminio/polistirene (PS)

		IP50	500mA	19W	CCT 3000 / 4000K	2400 / 2500lm	1007296 ● 349,00 EUR	
							1007297 ● 349,00 EUR	



MEDO® PRO 60 CW, DALI, UGR<19



220-240V ~50/60Hz
Materiale: alluminio/polistirene (PS)

		IP50	1000mA	39W	CCT 3000 / 4000K	5000 / 5100lm	1007300 ● 699,00 EUR	
							1007301 ● 699,00 EUR	

MEDO® PRO 60 CW, Phase, UGR<19



220-240V ~50/60Hz
Materiale: alluminio/polistirene (PS)

		IP50	1000mA	37W	CCT 3000 / 4000K	5000 / 5100lm	1007304 ● 629,00 EUR	
							1007305 ● 629,00 EUR	

MEDO® PRO 90 CL, DALI, UGR<19



220-240V ~50/60Hz
Materiale: alluminio/polistirene (PS)

		IP50	1000mA	75W	CCT 3000 / 4000K	9400 / 9700lm	1007308 ● 1.449,00 EUR	
							1007309 ● 1.449,00 EUR	

MEDO® PRO 90 CL, Phase, UGR<19



220-240V ~50/60Hz
Materiale: alluminio/polistirene (PS)

		IP50	1000mA	74W	CCT 3000 / 4000K	9400 / 9700lm	1007312 ● 1.249,00 EUR	
							1007313 ● 1.249,00 EUR	



DIFFUSORE OPALE (UGR<25)

MEDO® PRO 30 CW, DALI



220-240V ~50/60Hz
Materiale: alluminio/polistirene (PS)

		IP50	250mA	10W	CCT 3000 / 4000K	1350 / 1350lm	1007286 ● 329,00 EUR	
							1007287 ● 329,00 EUR	

MEDO® PRO 30 CW, Phase



220-240V ~50/60Hz
Materiale: alluminio/polistirene (PS)

		IP50	250mA	10W	CCT 3000 / 4000K	1350 / 1350lm	1007290 ● 299,00 EUR	
							1007291 ● 299,00 EUR	

MEDO® PRO 40 CW, DALI



220-240V ~50/60Hz
Materiale: alluminio/polistirene (PS)

		IP50	500mA	19W	CCT 3000 / 4000K	2650 / 2650lm	1007294 ● 449,00 EUR	
							1007295 ● 449,00 EUR	

MEDO® PRO 40 CW, Phase



220-240V ~50/60Hz
Materiale: alluminio/polistirene (PS)

		IP50	500mA	19W	CCT 3000 / 4000K	2650 / 2650lm	1007298 ● 349,00 EUR	
							1007299 ● 349,00 EUR	





MEDO® PRO 60 CW, DALI



220-240V ~50/60Hz
Materiale: alluminio/polistirene (PS)

		IP50	1000mA	39W	CCT 3000 / 4000K	5450 / 5500lm	1007302 ● 699,00 EUR	
							1007303 ● 699,00 EUR	

MEDO® PRO 60 CW, Phase



220-240V ~50/60Hz
Materiale: alluminio/polistirene (PS)

		IP50	1000mA	37W	CCT 3000 / 4000K	5450 / 5500lm	1007306 ● 629,00 EUR	
							1007307 ● 629,00 EUR	

MEDO® PRO 90 CL, DALI



220-240V ~50/60Hz
Materiale: alluminio/polistirene (PS)

		IP50	1000mA	75W	CCT 3000 / 4000K	11000 / 11200lm	1007310 ● 1.449,00 EUR	
							1007311 ● 1.449,00 EUR	

MEDO® PRO 90 CL, Phase



220-240V ~50/60Hz
Materiale: alluminio/polistirene (PS)

		IP50	1000mA	74W	CCT 3000 / 4000K	11000 / 11200lm	1007314 ● 1.249,00 EUR	
							1007315 ● 1.249,00 EUR	



	nero	135250	44,75 EUR
Set per sospensione 1,5 m	bianco	135251	44,75 EUR
	grigio	135254	44,75 EUR
	nero	1001952	99,00 EUR
Set per sospensione 5 m	bianco	1001950	99,00 EUR
	grigio	1001951	99,00 EUR

MEDO® PRO 60
1006417 (DC)

MEDO® PRO 40
1006414 (DC)



ILLUMINAZIONE SUGGESTIVA

Le nuove versioni MEDO®, grazie alla componente di luce indiretta, fanno risplendere anche lo sfondo. In questo modo si ottiene un'illuminazione piacevole, omogenea e non abbagliante degli ambienti.

MEDO® PRO
Lampade da parete e a plafone
(CW), DC



NEW

Set per sospensione escluso



Installazione facile
e rapida grazie
a EasyBase



Diffusore prismatico anti
abbagliamento UGR<19

Il retro trasparente garantisce
una diffusione ottimale della
luce indiretta

Straordinaria resa cromatica
CRI>90

ILLUMINAZIONE D'EMERGENZA

Con MEDO® PRO DC godrete di tutti i vantaggi tecnici della versione prismatica MEDO® PRO con UGR<19. Grazie al driver integrato compatibile con la corrente continua, avrete la sicurezza che gli apparecchi funzionino anche collegati ad un impianto di emergenza fornendo un'illuminazione all'avanguardia.



MEDO® PRO 60
1006417 (DC)



MEDO® PRO 30
1006411 (DC)



Trova ulteriori
ispirazioni nella nostra
brochure MEDO®

**MEDO® PRO 30**
CW, DALI, UGR<19, DC220-240V ~50/60Hz
Materiale: alluminio/polistirene (PS)

		IP50	250mA	10W	CCT 3000 / 4000K	1250 / 1250lm	1006411 ● 379,00 EUR
							1006412 ● 379,00 EUR

**MEDO® PRO 40**
CW, DALI, UGR<19, DC220-240V ~50/60Hz
Materiale: alluminio/polistirene (PS)

		IP50	500mA	19W	CCT 3000 / 4000K	2400 / 2500lm	1006414 ● 449,00 EUR
							1006415 ● 449,00 EUR

**MEDO® PRO 60**
CW, DALI, UGR<19, DC220-240V ~50/60Hz
Materiale: alluminio/polistirene (PS)

		IP50	1000mA	37W	CCT 3000 / 4000K	5000 / 5100lm	1006417 ● 749,00 EUR
							1006418 ● 749,00 EUR

**MEDO® PRO 90**
CL, DALI, UGR<19, DC220-240V ~50/60Hz
Materiale: alluminio/polistirene (PS)

		IP50	1000mA	75W	CCT 3000 / 4000K	9400 / 9700lm	1006420 ● 1.549,00 EUR
							1006421 ● 1.549,00 EUR



+			
	nero	135250	44,75 EUR
Set per sospensione 1,5 m	bianco	135251	44,75 EUR
	grigio	135254	44,75 EUR
	nero	1001952	99,00 EUR
Set per sospensione 5 m	bianco	1001950	99,00 EUR
	grigio	1001951	99,00 EUR

MEDO® 60
1007322

MEDO® 90
1007325



ILLUMINAZIONE SUGGESTIVA

Le nuove versioni MEDO®, grazie alla componente di luce indiretta, fanno risplendere anche lo sfondo. In questo modo si ottiene un'illuminazione piacevole, omogenea e non abbagliante degli ambienti.



MEDO®
Lampade da parete e a plafone (CW)



NEW

Set per sospensione escluso

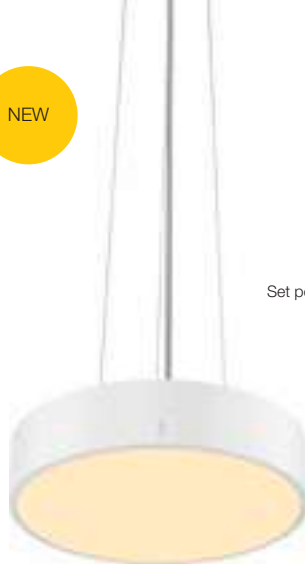

Installazione facile
e rapida grazie
a EasyBase

Straordinaria resa cromatica
CRI>90

Selezione della temperatura del
colore tramite interruttore CCT
(2700/3000/4000K)

Il retro trasparente garantisce
una diffusione ottimale della
luce indiretta



MEDO® 30
1007317



**MEDO® 30**
CW, Phase220-240V ~50/60Hz
Materiale: alluminio/polistirene (PS)

IP50

250mA

12W

CCT
2700 / 3000 / 4000K

1050 / 1100 / 1200lm

1007316 ● 265,00 EUR

1007317 ● 265,00 EUR

1007318 ● 265,00 EUR

**MEDO® 40**
CW, Phase220-240V ~50/60Hz
Materiale: alluminio/polistirene (PS)

IP50

500mA

20W

CCT
2700 / 3000 / 4000K

2100 / 2200 / 2350lm

1007319 ● 294,00 EUR

1007320 ● 294,00 EUR

1007321 ● 294,00 EUR

**MEDO® 60**
CW, Phase220-240V ~50/60Hz
Materiale: alluminio/polistirene (PS)

IP50

1000mA

39W

CCT
2700 / 3000 / 4000K

4050 / 4250 / 4550lm

1007322 ● 559,00 EUR

1007323 ● 559,00 EUR

1007324 ● 559,00 EUR

**MEDO® 90**
CL, Phase220-240V ~50/60Hz
Materiale: alluminio/polistirene (PS)

IP50

1000mA

79W

CCT
2700 / 3000 / 4000K

8300 / 8700 / 9350lm

1007325 ● 1.099,00 EUR

1007326 ● 1.099,00 EUR

1007327 ● 1.099,00 EUR



Set per sospensione 1,5 m	nero	135250	44,75 EUR
	bianco	135251	44,75 EUR
	grigio	135254	44,75 EUR
Set per sospensione 5 m	nero	1001952	99,00 EUR
	bianco	1001950	99,00 EUR
	grigio	1001951	99,00 EUR

MEDO®: INSTALLAZIONE SEMPLICE

Le nuove versioni MEDO® sono tutte facili e veloci da installare grazie al nostro sistema EasyBase. Usa EasyBase direttamente come dima per i fori ed esegui il cablaggio subito dopo averlo fissato in posizione. Successivamente, seleziona la temperatura del colore utilizzando l'interruttore CCT, fai corrispondere i due riferimenti verdi e infine inserisci la lampada fino a quando sentirai uno scatto.

LAMPADE A PLAFONE

Fissare EasyBase al soffitto

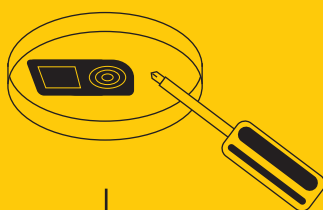

Cablare EasyBase



Selezionare la temperatura del colore tramite l'interruttore CCT e agganciare l'apparecchio, prestando attenzione ai segni verdi

MEDO® 60 e MEDO® 90 vengono fissati ulteriormente con la catena di sicurezza disponibile

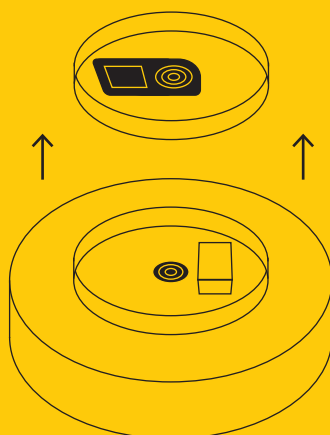

Installazione facile
e rapida grazie
a EasyBase

INCASSI
SENZA CORNICE

INCASSI
CON CORNICE

Posizionare il telaio da
incasso nel soffitto

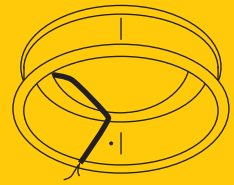
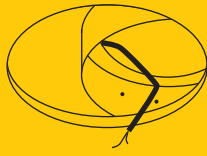

Posizionare e fissare le
piastre di montaggio

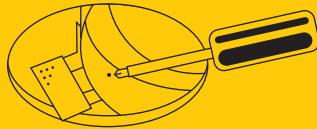

Avvitare le piastre di montaggio
al soffitto e stuccare

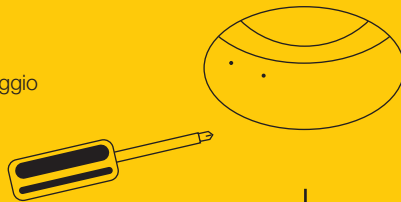

Collegare il driver LED

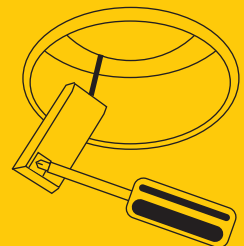
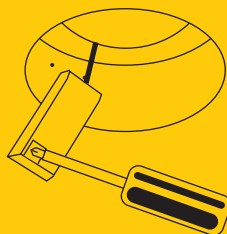

Inserire il modulo LED e selezionare
la temperatura del colore tramite
interruttore CCT

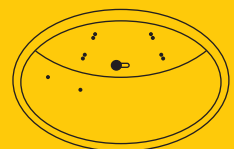

Inserire il diffusore



MEDO® 60
1002882

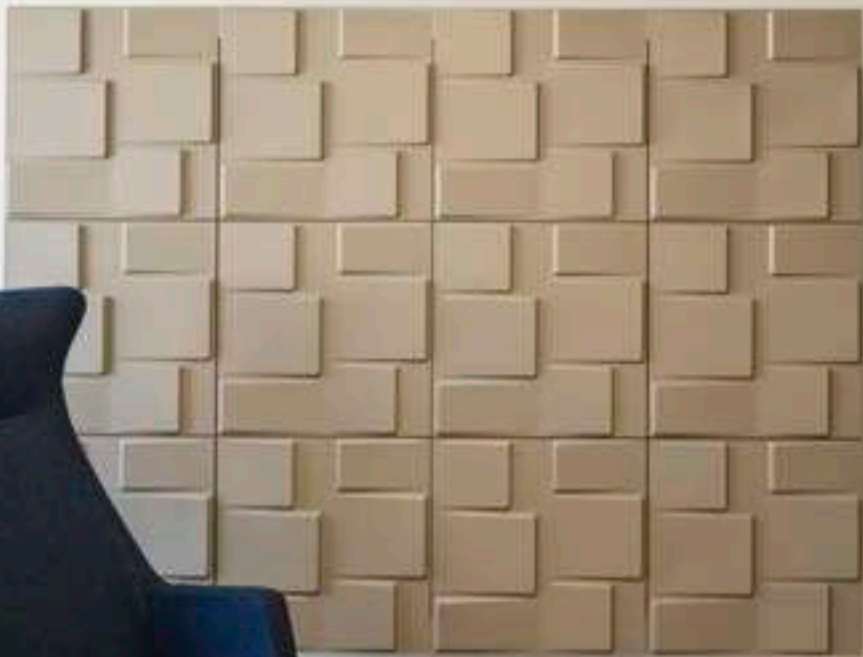
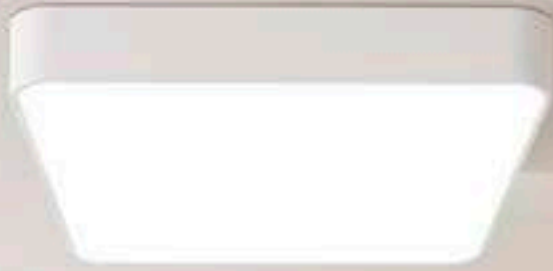



MEDO® Lampade a plafone (CL)



Set per sospensione escluso



MEDO® 60 CL, quadrato, 1-10V



220-240V ~50/60Hz
Materiale: alluminio/acrilico

		IP20	1000mA	39W	3000K	3800lm	1000726	499,00 EUR	
--	--	------	--------	-----	-------	--------	---------	------------	--

MEDO® 60 CL, quadrato, DALI



220-240V ~50/60Hz
Materiale: alluminio/acrilico

		IP20	1000mA	39W	3000K	3800lm	1002882	549,00 EUR	
--	--	------	--------	-----	-------	--------	---------	------------	--



	nero	135250	44,75 EUR
Set per sospensione 1,5 m	bianco	135251	44,75 EUR
	grigio	135254	44,75 EUR
	nero	1001952	99,00 EUR
Set per sospensione 5 m	bianco	1001950	99,00 EUR
	grigio	1001951	99,00 EUR



MEDO® RING 60
133840



MEDO® RING

Lampade a sospensione (PD)



MEDO® RING
Formati 60 e 90

MEDO® RING 60 PD, 1-10V

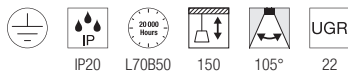

220-240V ~50/60Hz
Materiale: alluminio/polimetilmetacrilato (PMMA)

		IP20	700mA	33W	3000K	2200lm
--	--	------	-------	-----	-------	--------

133840	699,00 EUR
133841	699,00 EUR



MEDO® RING 90 PD, 1-10V

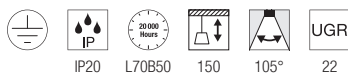

220-240V ~50/60Hz
Materiale: alluminio/polimetilmetacrilato (PMMA)

		IP20	1200mA	56W	3000K	4900lm
--	--	------	--------	-----	-------	--------

133850	869,00 EUR
133851	869,00 EUR



MEDO® RING 60 PD, DALI



220-240V ~50/60Hz
Materiale: alluminio/polimetilmetacrilato (PMMA)

		IP20	700mA	34W	3000K	2200lm
--	--	------	-------	-----	-------	--------

1002890	729,00 EUR
1002891	729,00 EUR



MEDO® 60
1001907

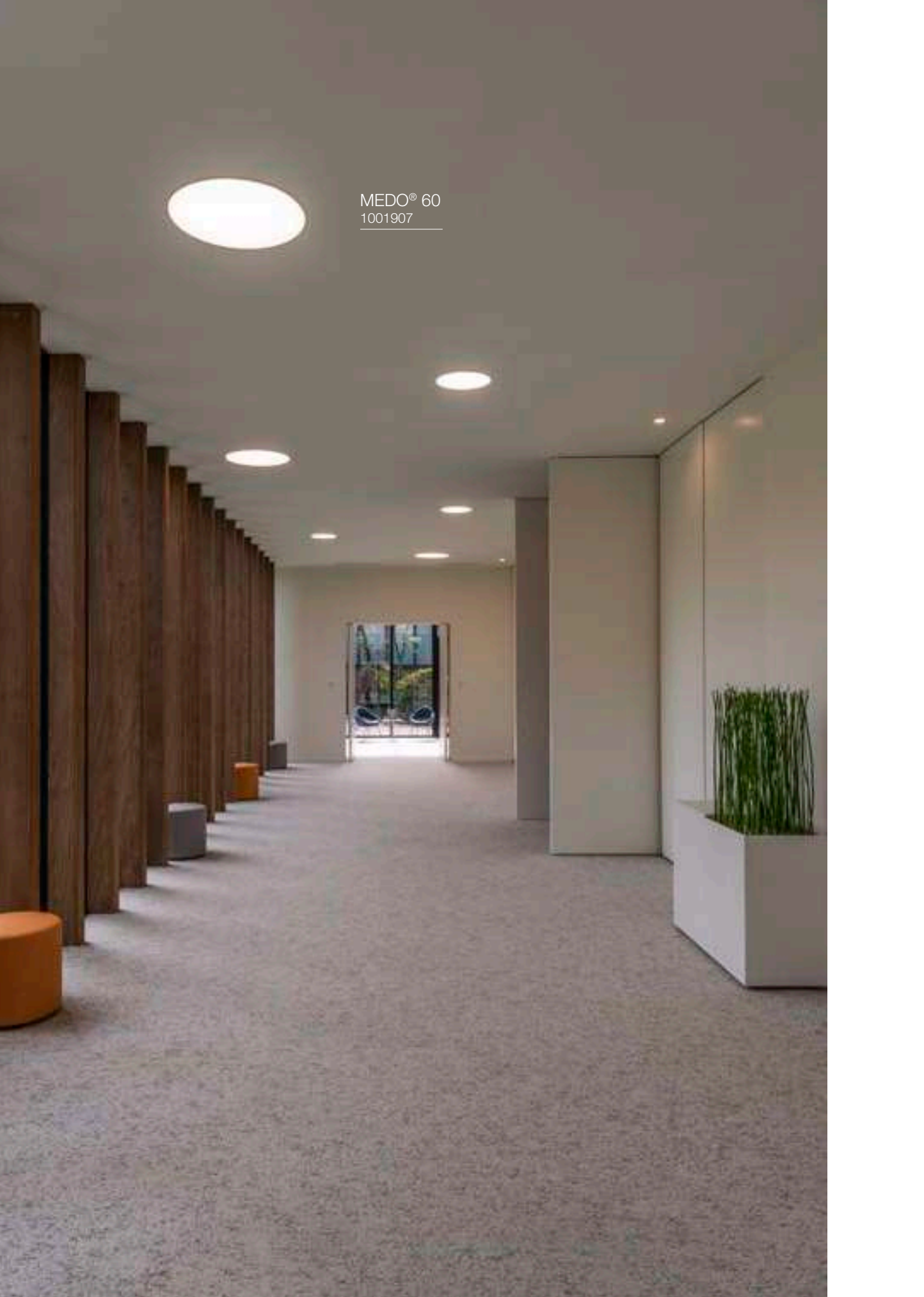

MEDO®
Incassi (EL)



MEDO® 30, 40 e 60
EL, senza cornice



MEDO® 30, 40 e 60
EL, con cornice



SENZA CORNICE

MEDO® 30 EL, Senza cornice



Materiale: alluminio/polimetilmetacrilato (PMMA)

○ - IP20 350mA 14W CCT 3000 / 4000K 1500 / 1600lm **1001901 209,00 EUR**



MEDO® 40 EL, Senza cornice



Materiale: alluminio/polimetilmetacrilato (PMMA)

○ - IP20 700mA 28W CCT 3000 / 4000K 3100 / 3300lm **1001902 235,00 EUR**



MEDO® 60 EL, Senza cornice



Materiale: alluminio/polimetilmetacrilato (PMMA)

○ - IP20 1000 / 1050mA 36W CCT 3000 / 4000K 4700 / 5000lm **1001903 499,00 EUR**



Driver LED non inclusi,
ma disponibili separatamente.
Qui trovate i driver adatti:





CON CORNICE

MEDO® 30
EL, Con cornice

Materiale: alluminio/polimetilmetacrilato (PMMA)

○ - IP20 350mA 14W CCT 3000 / 4000K 1500 / 1600lm **1001905** **219,00 EUR**MEDO® 40
EL, Con cornice

Materiale: alluminio/polimetilmetacrilato (PMMA)

○ - IP20 700mA 28W CCT 3000 / 4000K 3100 / 3300lm **1001906** **249,00 EUR**MEDO® 60
EL, Con cornice

Materiale: alluminio/polimetilmetacrilato (PMMA)

○ - IP20 1000 / 1050mA 38W CCT 3000 / 4000K 4700 / 5000lm **1001907** **549,00 EUR**

DRIVER LED



DRIVER LED 250-700mA, 1-10V / DALI CON SERRACAVO MEDO® 30 + 60	bianco	20W	1-10V / DALI	L: 15 cm, La: 5,2 cm, H: 2,8 cm	1002423	85,00 EUR
DRIVER LED 500-1050mA, 1-10V / DALI CON SERRACAVO MEDO® 40	bianco	40W	1-10V / DALI	L: 14,2 cm, La: 4,4 cm, H: 3 cm	1002424	90,00 EUR
DRIVER LED 700mA CON SERRACAVO MEDO® 40	bianco	40W	C	L: 14,5 cm, La: 4 cm, H: 3 cm	1005446	45,00 EUR
DRIVER LED 1050mA CON SERRACAVO MEDO® 30 + 60	bianco	40W	C	L: 16,6 cm, La: 5,2 cm, H: 2,4 cm	464804	57,00 EUR
DRIVER LED 700 / 900 / 1000mA CON SERRACAVO MEDO® 30 + 40 + 60	bianco	40W	-	L: 12,3 cm, La: 7,9 cm, H: 3 cm	1006120	57,00 EUR

MEDO® PANORAMICA



MEDO® PRO
CW

MEDO® PRO (DC)
CW

MEDO®
CW

Formati:	30 40 60 90	30 40 60 90	30 40 60 90
Set per sospensione	1,5 5 m (escluso)	1,5 5 m (escluso)	1,5 5 m (escluso)
EasyBase	✓	✓	✓
Interruttore CCT	✓	✓	✓
DALI	✓	✓	-
Taglio di fase	C	-	C
1-10V	-	-	-
UGR	19 25	19	22 25
DC	-	✓	-

Driver LED non inclusi
disponibili separatamente.



MEDO®
CL, QUADRATO

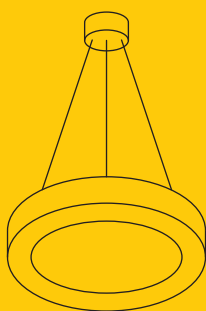

MEDO® RING
PD

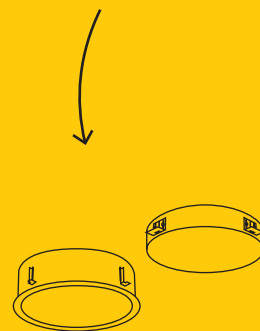

MEDO®
EL, SENZA CORNICE | CON CORNICE

	60	60	30 40 60
	1,5 5 m (escluso)	1,5 m (incluso)	-
	-	-	-
	-	-	✓
	✓	✓	✓*
	-	-	✓*
	✓	✓	✓*
	22	22	25
	-	-	-

MEDO® DIMENSIONI:

INCASSI

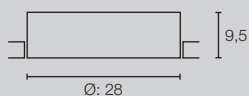

Dimensioni di incasso:
 $\varnothing: 29$ cm P: 13 cm

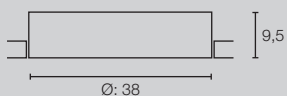

Dimensioni di incasso:
 $\varnothing: 39$ cm P: 13 cm

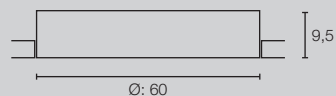

Dimensioni di incasso:
 $\varnothing: 61$ cm P: 16 cm

MEDO® 30 EL, SENZA CORNICE

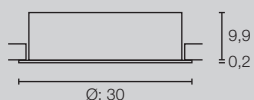

Dimensioni di incasso:
 $\varnothing: 29$ cm P: 13 cm

MEDO® 40 EL, SENZA CORNICE

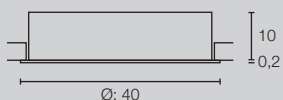

Dimensioni di incasso:
 $\varnothing: 39$ cm P: 13 cm

MEDO® 60 EL, SENZA CORNICE

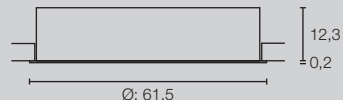

Dimensioni di incasso:
 $\varnothing: 61$ cm P: 16 cm

MEDO® 30 EL, CON CORNICE

MEDO® 40 EL, CON CORNICE

MEDO® 60 EL, CON CORNICE

LAMPADA A PLAFONE

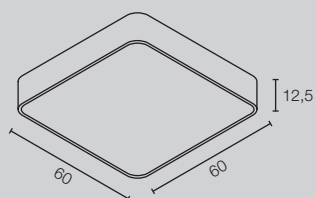

MEDO® 60 CL, QUADRATO

LAMPADE A SOSPENSIONE

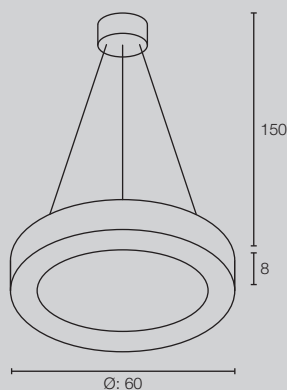

MEDO® RING 60 PD

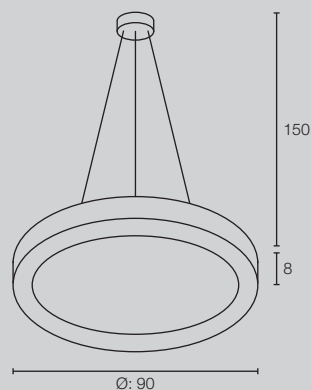

MEDO® RING 90 PD



Tutte le lampade a
plafone possono essere
utilizzate anche come
sospensioni

LAMPADE DA PARETE E A PLAFONE

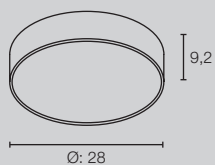

MEDO® PRO 30
CW, DC

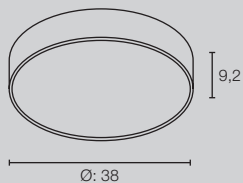

MEDO® PRO 40
CW, DC

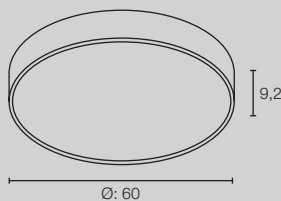

MEDO® PRO 60
CW, DC

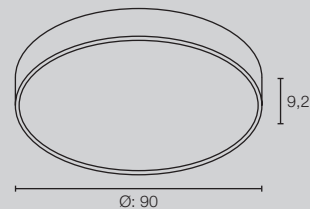

MEDO® PRO 90
CL, DC

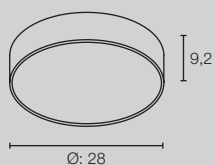

MEDO® PRO 30
CW

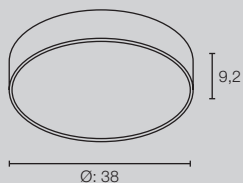

MEDO® PRO 40
CW

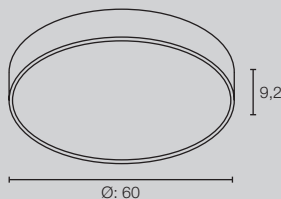

MEDO® PRO 60
CW

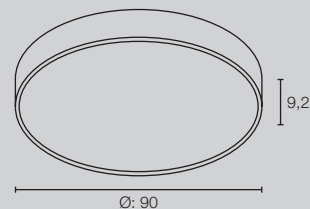

MEDO® PRO 90
CL

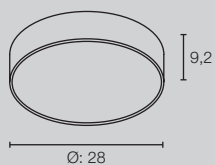

MEDO® 30
CW

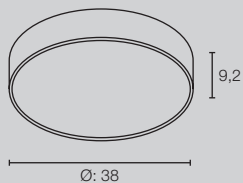

MEDO® 40
CW

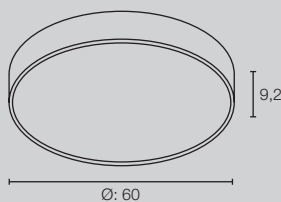

MEDO® 60
CW

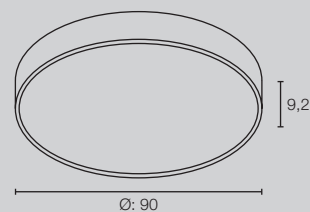

MEDO® 90
CL

LALU®
1007550



LALU®
Sospensioni (PD)

NEW

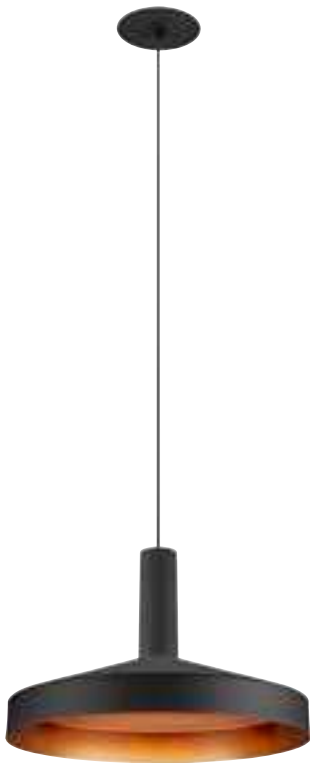
Abbina i colori e le forme
delle sospensioni LALU®LALU®
PD, LED Base, Phase220-240V ~50/60Hz
Materiale: alluminio/acciaio

IP20

500mA

9,5W

3000K

680lm

1007518 ● 169,00 EUR

1007519 ● 169,00 EUR

1007520 ● 175,00 EUR

MIX
matchLALU®
PD, LED Base, Phase, Recessed220-240V ~50/60Hz
Materiale: alluminio/acciaio

IP20

500mA

9,5W

3000K

680lm

1007548 ● 149,00 EUR

1007549 ● 149,00 EUR

1007550 ● 155,00 EUR



SCEGLI IL DIFFUSORE ADATTO ALLE TUE ESIGENZE



LALU® TETRA 14	nero/bronzo antico				1007523	55,00 EUR	
	bianco/oro	IP20	Ø: 14 cm, H: 4,9 cm		1007522	55,00 EUR	
	bronzo antico				1007521	58,00 EUR	
LALU® TETRA 24	nero/bronzo antico				1007526	72,00 EUR	
	bianco/oro	IP20	Ø: 24 cm, H: 6,7 cm		1007525	72,00 EUR	
	bronzo antico				1007524	78,00 EUR	
LALU® TETRA 36	nero/bronzo antico				1007529	114,00 EUR	
	bianco/oro	IP20	Ø: 36 cm, H: 8,9 cm		1007528	114,00 EUR	
	bronzo antico				1007527	126,00 EUR	
LALU® CONE 15	nero/bronzo antico				1007532	57,00 EUR	
	bianco/oro	-	Ø: 15,2 cm, H 17 cm		1007531	57,00 EUR	
	bronzo antico				1007530	65,00 EUR	
LALU® ELYPSE 15	nero/bronzo antico				1007535	36,00 EUR	
	bianco/oro	-	Ø: 15 cm, H 1,4 cm		1007534	36,00 EUR	
	bronzo antico				1007533	42,00 EUR	
LALU® ELYPSE 22	nero/bronzo antico				1007538	57,00 EUR	
	bianco/oro	-	Ø: 22 cm, H 2,8 cm		1007537	57,00 EUR	
	bronzo antico				1007536	65,00 EUR	
LALU® ELYPSE 33	nero/bronzo antico				1007541	89,00 EUR	
	bianco/oro	-	Ø: 33 cm, H 3,5 cm		1007540	89,00 EUR	
	bronzo antico				1007539	95,00 EUR	
LALU® PLATE 15	nero/bronzo antico				1007544	42,00 EUR	
	bianco/oro	-	Ø: 15 cm, H 1,5 cm		1007543	42,00 EUR	
	bronzo antico				1007542	45,00 EUR	
LALU® PLATE 22	nero/bronzo antico				1007547	55,00 EUR	
	bianco/oro	-	Ø: 22 cm, H 1,5 cm		1007546	55,00 EUR	
	bronzo antico				1007545	59,00 EUR	



MIX & MATCH

LALU®

LALU® TETRA 14

nero | 1007523
bianco | 1007522
bronzo antico | 1007521



LALU® CONE 15

nero | 1007532
bianco | 1007531
bronzo antico | 1007530

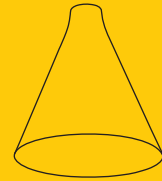

LALU® TETRA 24

nero | 1007526
bianco | 1007525
bronzo antico | 1007524



LALU® TETRA 36

nero | 1007529
bianco | 1007528
bronzo antico | 1007527



LALU®

PD, LED BASE, PHASE

nero | 1007518
bianco | 1007519
bronzo antico | 1007520



LALU®

PD, LED BASE, PHASE, RECESSED

nero | 1007548
bianco | 1007549
bronzo antico | 1007550



LALU® ELYPSE 15

nero | 1007535
bianco | 1007534
bronzo antico | 1007533



LALU® PLATE 15

nero | 1007544
bianco | 1007543
bronzo antico | 1007542



LALU® ELYPSE 22

nero | 1007538
bianco | 1007537
bronzo antico | 1007536



LALU® PLATE 22

nero | 1007547
bianco | 1007546
bronzo antico | 1007545



LALU® ELYPSE 33

nero | 1007541
bianco | 1007540
bronzo antico | 1007539



LALU®

PD, LED BASE, 48V, DALI

nero | 1007749
bianco | 1007748
bronzo antico | 1007747



Abbina i prodotti della famiglia LALU® in base ai tuoi gusti. Grazie alla loro armonia perfetta, è possibile abbinare forme, dimensioni e colori o creare composizioni multiple. Libera la creatività: i prodotti Mix & Match di SLV sono contraddistinti dal seguente simbolo:



MIX
match

LALU®
1007658





LALU®
Sospensione (PD)

SOCKET
INSIDE

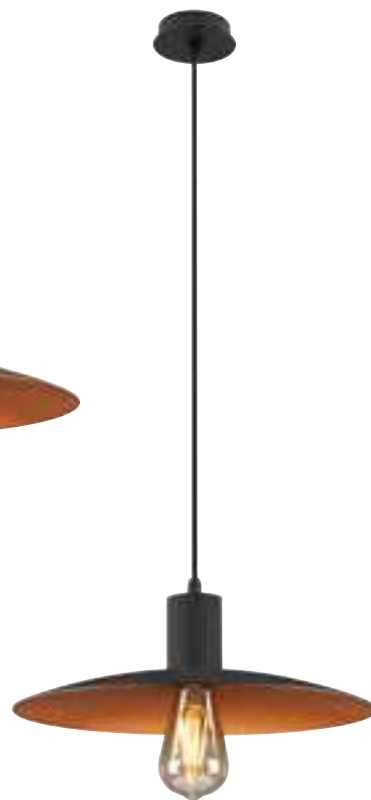

LALU®
PD, E27



IP20

150

220-240V ~50/60Hz
Materiale: alluminio

● - IP20 - 10W 1xE27 - 1007658 ● 149,00 EUR



LALU®
Shade, E27 Base

nero/bronzo antico

Ø: 33 cm, H: 3,5 cm

1007659 ● 149,00 EUR

bronzo antico

1007660 ● 169,00 EUR



A60
180°, Classe=F, 8kWh/1000h



7,5W

2700K

720lm

- 1005305

19,00 EUR

LALU® DIMENSIONI

SOSPENSIONI LALU

MIX
match



LALU® TETRA 14
PD, SHADE

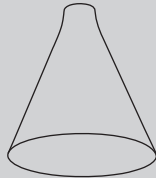

LALU® CONE 15
PD, SHADE



LALU® ELYPSE 15
PD, SHADE



LALU® PLATE 15
PD, SHADE



LALU® TETRA 24
PD, SHADE



LALU® ELYPSE 22
PD, SHADE



LALU® PLATE 22
PD, SHADE

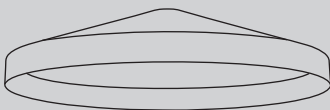

LALU® TETRA 36
PD, SHADE



LALU® ELYPSE 33
PD, SHADE

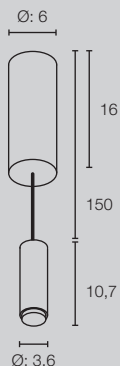

LALU®
PD, LED BASE, PHASE

Dimensioni di incasso:
Ø: 6,8 cm P: 5 cm

LALU®
PD, LED BASE, PHASE, RECESSED

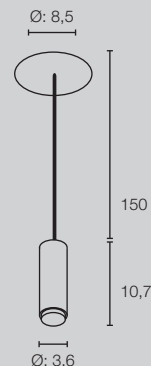

Ø: 3,6

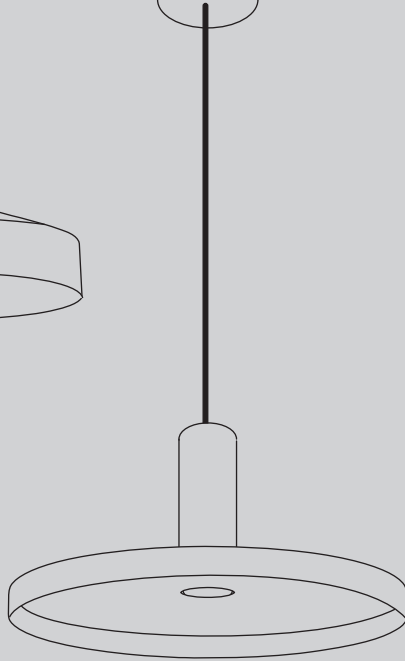
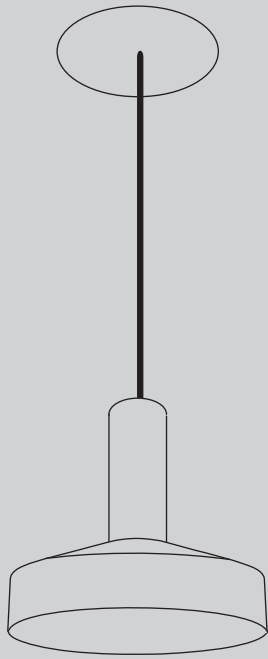

LALU®
PD, SHADE

SOCKET
INSIDE

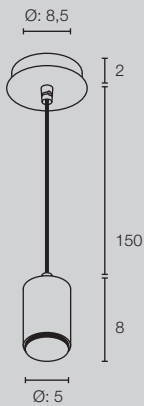

LALU®
PD, E27

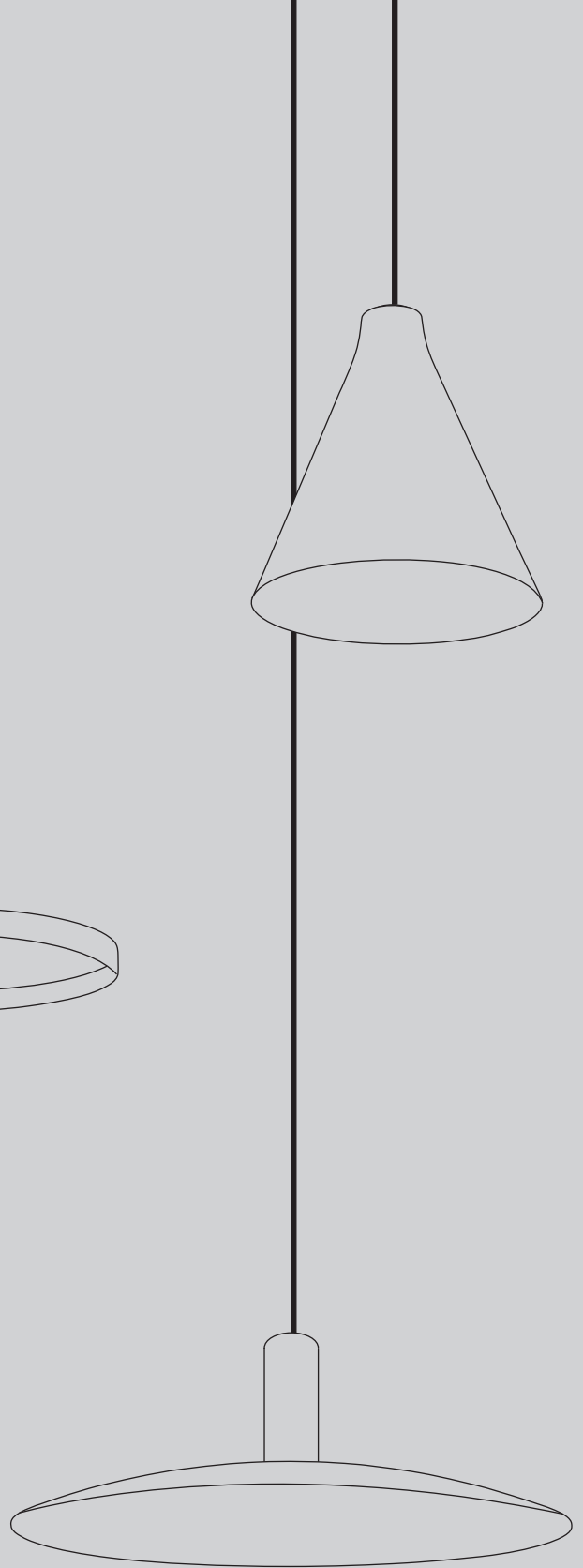

ONE® 60
1005177





ONE®
Sospensioni (PD)



ONE® TRIPLE DALI



ONE® 60 DALI



ONE® DOUBLE
PD DALI UP/DOWN

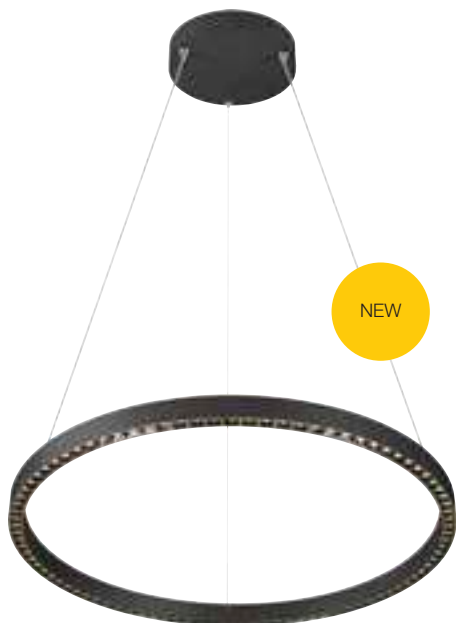

ONE® CUBE
DALI UP/DOWN

ONE® 60 PD, Dali



220-240V ~50/60Hz
Materiale: alluminio/acciaio

		IP20	600mA	24W	CCT 3000 / 4000K	1480 / 1550lm	1002909	423,00 EUR	
	2.0						1002910	423,00 EUR	

ONE® 60 PD, Up/Down, Dali

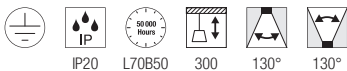

220-240V ~50/60Hz
Materiale: alluminio/acciaio

		IP20	600mA	25W	CCT 3000 / 4000K	400 / 410lm	1004761	535,00 EUR	
	2.0					800 / 820lm	1004762	535,00 EUR	

ONE® 60 PD, Up/Down, Phase



220-240V ~50/60Hz
Materiale: alluminio/acciaio

		IP20	600mA	24W	CCT 2700 / 3000K	410 / 415lm	1004759	484,00 EUR	
	C						1004760	484,00 EUR	
							1005177	504,00 EUR	

ONE® 80 PD, Dali



220-240V ~50/60Hz
Materiale: alluminio/acciaio

		IP20	800mA	32W	CCT 3000 / 4000K	1930 / 2140lm	1002911	474,00 EUR	
	2.0						1002912	474,00 EUR	

ONE® 80 PD, Up/Down, Dali



220-240V ~50/60Hz
Materiale: alluminio/acciaio

		IP20	800mA	34W	CCT 3000 / 4000K	615 / 635lm	1004763	636,00 EUR	
	2.0						1004764	636,00 EUR	



ONE® DOUBLE PD, Up/Down, Dali

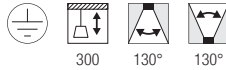

220-240V ~50/60Hz
Materiale: alluminio/acciaio

		-	1400mA	55W	CCT 3000 / 4000K	1050 / 1060lm

1004767	1.110,00 EUR
1004768	1.110,00 EUR



ONE® DOUBLE PD, Up/Down, Phase

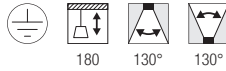

220-240V ~50/60Hz
Materiale: alluminio/acciaio

		-	900mA	35W	CCT 2700 / 3000K	615 / 635lm

1004765	827,00 EUR
1004766	827,00 EUR
1005178	848,00 EUR



ONE® TRIPLE PD, Dali

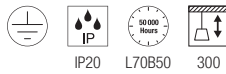

220-240V ~50/60Hz
Materiale: alluminio/acciaio

		IP20	1700mA	64W	CCT 3000 / 4000K	4040 / 4200lm
		2.0				

1002913	1.110,00 EUR
1002914	1.110,00 EUR



ONE® CUBE PD, Dali



220-240V ~50/60Hz
Materiale: alluminio/acciaio

		IP20	1400mA	54W	3000K	4000lm
		2.0				
		IP20	1400mA	54W	4000K	4300lm

1007661		629,00 EUR
1007662		629,00 EUR
1007663		629,00 EUR
1007664		629,00 EUR



ONE® CUBE PD, Up/Down, Dali



220-240V ~50/60Hz
Materiale: alluminio/acciaio

		IP20	2100mA	80W	3000K	UP 2000lm DOWN 4000lm
		IP20	2100mA	80W	4000K	UP 2200lm DOWN 4300lm

1007665		699,00 EUR
1007666		699,00 EUR
1007671		699,00 EUR
1007672		699,00 EUR



ONE® LINEAR 140
1006190





ONE® LINEAR 100

ONE® LINEAR 140

ONE® LINEAR 100
PD, Up/Down, Phase

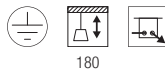

180

220-240V ~50/60Hz
Materiale: alluminio/acciaio

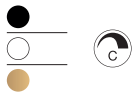

- 600mA 24W CCT 2700 / 3000K

UP 550 / 580lm
DOWN 670 / 700lm

1006185	312,00 EUR
1006186	312,00 EUR
1006187	333,00 EUR



ONE® LINEAR 140
PD, Up/Down, Phase

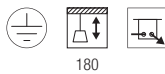

180

220-240V ~50/60Hz
Materiale: alluminio/acciaio

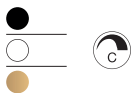

- 900mA 35W CCT 2700 / 3000K

UP 830 / 860lm
DOWN 980 / 1015lm

1006188	368,00 EUR
1006189	368,00 EUR
1006190	388,00 EUR



Per le dimensioni dettagliate e le informazioni sul montaggio consultare le pagine 200-201

ONE® 60
1002919



ONE® DOUBLE
1004766





ONE®
Lampade da parete e a plafone
(CW)

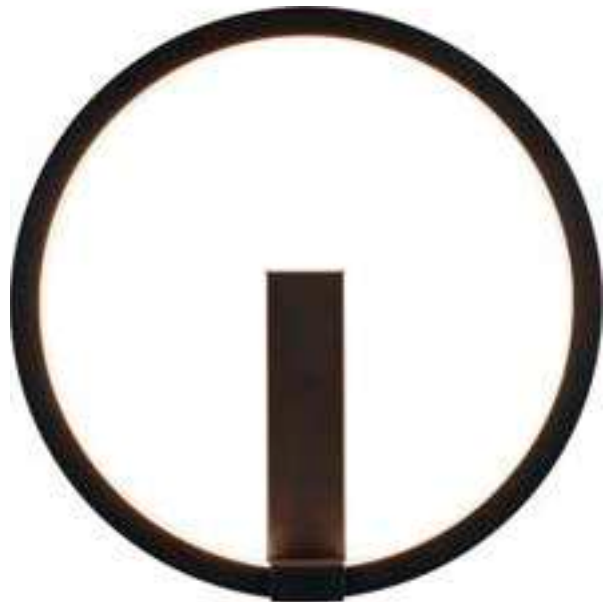

ONE® 40
CW, Dali



220-240V ~50/60Hz
Materiale: alluminio/acciaio

● ○	Dali 2.0	IP20	350mA	14W	CCT 3000 / 4000K	700 / 730lm	1002915	343,00 EUR	
							1002917	343,00 EUR	

ONE® 60
CW, Dali



220-240V ~50/60Hz
Materiale: alluminio/acciaio

● ○	Dali 2.0	IP20	600mA	24W	CCT 3000 / 4000K	1350 / 1430lm	1002918	413,00 EUR	
							1002919	413,00 EUR	

Per le dimensioni dettagliate e le informazioni sul montaggio consultare le pagine 200-201



ONE® 40 TRACK
1004769

ONE® 40 TRACK
Binario Trifase, Dali

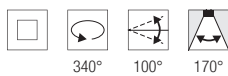

340° 100° 170°



220-240V ~50/60Hz
Materiale: alluminio

●	-	350mA	15,2W	3000K	650lm	1004769	333,00 EUR
○	-	350mA	15,2W	4000K	670lm	1004770	333,00 EUR
●	-	350mA	15,2W	4000K	670lm	1004771	333,00 EUR
○	-	350mA	15,2W	4000K	670lm	1004772	333,00 EUR



Per le dimensioni dettagliate e le informazioni sul montaggio consultare le pagine 200-201



ONE® 40 TRACK
1004771

ONE® 40 TRACK
Binario trifase



Orientabili di 340°
e ruotabili di 100°



ONE®
Lampade da terra (FL)



ONE® STRAIGHT
FL, Up/Down

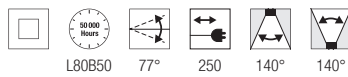

220-240V ~50/60Hz
Materiale: acciaio/policarbonato (PC)



-

24V

22W

CCT 2700 / 3000K

UP 600 / 600lm
DOWN 600 / 600lm

UGR<22

- 1006355 ● 849,00 EUR
- 1006354 ● 849,00 EUR
- 1006353 ● 849,00 EUR



Flusso luminoso degli anelli con regolazione individuale

NEW

ONE® BOW
FL, Up/Down

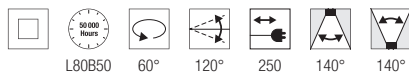

220-240V ~50/60Hz
Materiale: acciaio/polycarbonato (PC)



-

24V

22W

CCT 2700 / 3000K

UP 600 / 600lm
DOWN 600 / 600lm

UGR<22

- 1006352 ● 1.249,00 EUR
- 1006351 ● 1.249,00 EUR
- 1006350 ● 1.249,00 EUR

Per le dimensioni dettagliate e le informazioni sul montaggio consultare le pagine 200-201



ONE® STRAIGHT
1006353



ONE® BOW
1006351

ONE® DIMENSIONI

SOSPENSIONI

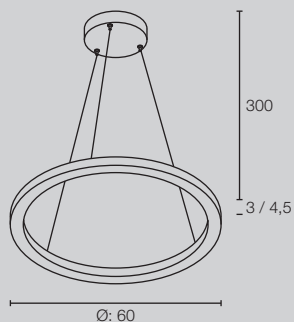

ONE® 60 / **ONE® 60**
PD, DALI / PD, UP/DOWN, DALI

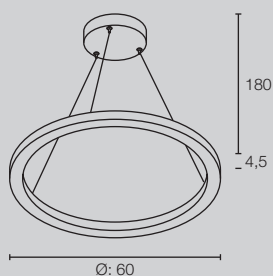

ONE® 60
PD, UP/DOWN, PHASE

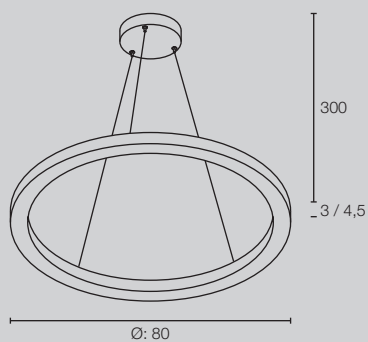

ONE® 80 / **ONE® 80**
PD, DALI / PD, UP/DOWN, DALI

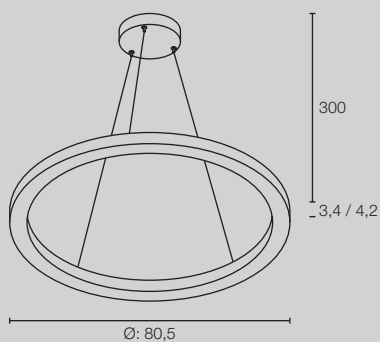

ONE® CUBE / **ONE® CUBE**
PD, DALI / PD, UP/DOWN, DALI

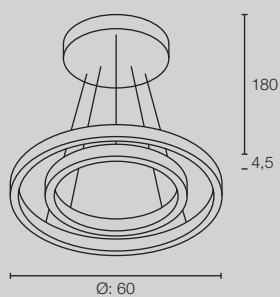

ONE® DOUBLE 60
PD, UP/DOWN, DALI

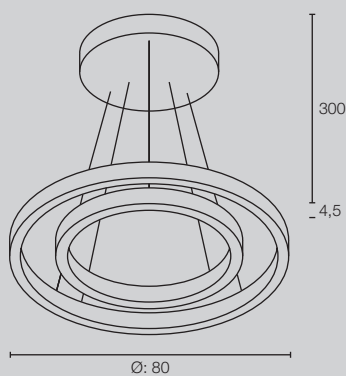

ONE® DOUBLE 80
PD, UP/DOWN, DALI

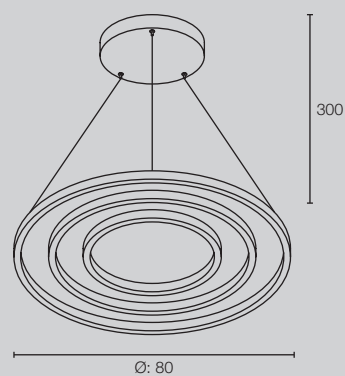

ONE® TRIPLE
PD, DALI

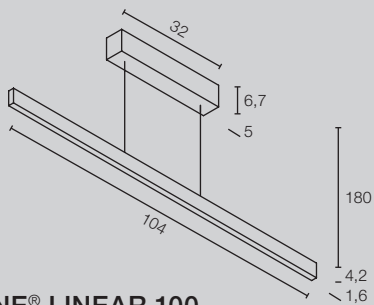

ONE® LINEAR 100
PD, UP/DOWN, DALI

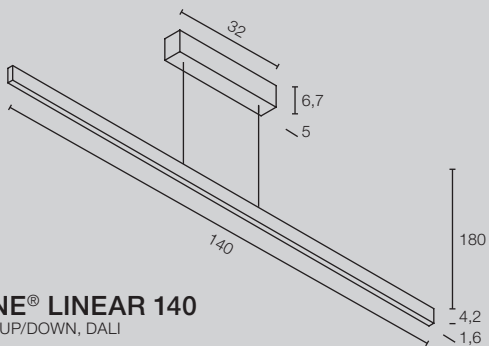

ONE® LINEAR 140
PD, UP/DOWN, DALI

LAMPADE DA PARETE

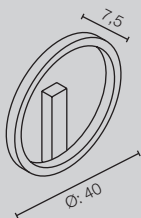

ONE® 40
CW, DALI

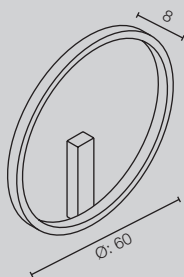

ONE® 60
CW, DALI

BINARIO TRIFASE

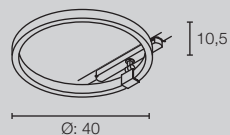

ONE® 40 TRACK
TRACK 3PH, DALI

LAMPADE DA TERRA



ONE® STRAIGHT
FL, UP/DOWN, SWITCH

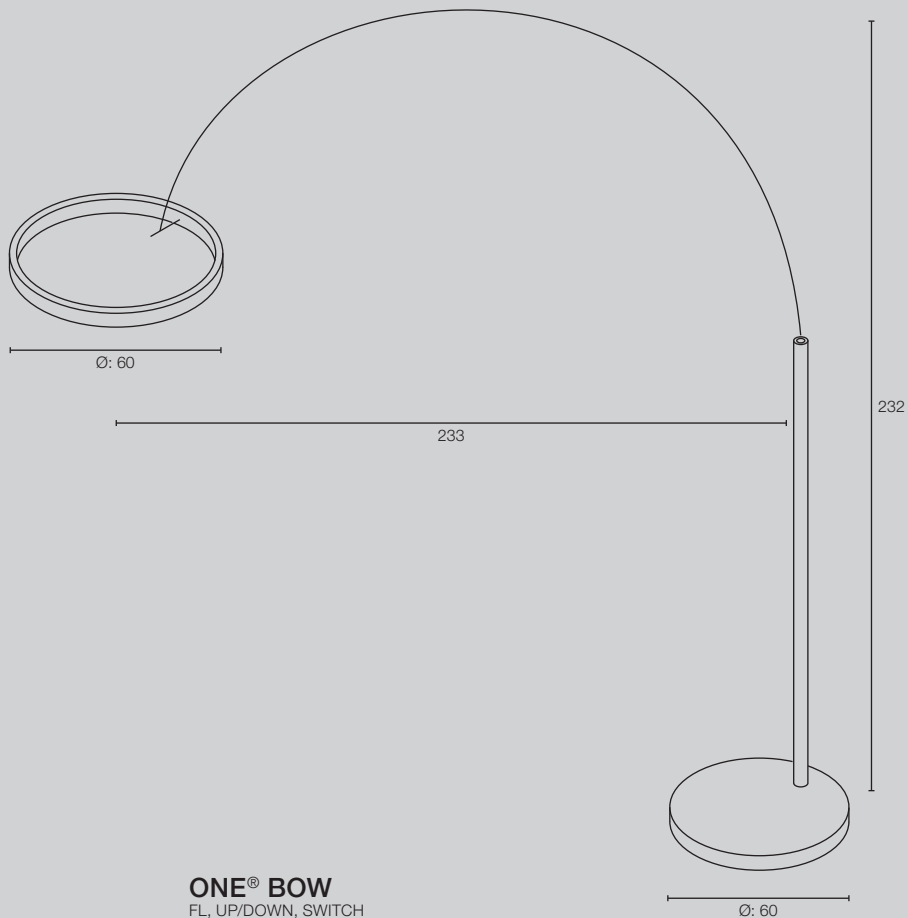

ONE® BOW
FL, UP/DOWN, SWITCH



NUMINOS®
alle pagine
82-93

LED



NEW TRIA®
alle pagine
122-147

LED



MEDO®
alle pagine
168-171

LED



NEW

LED

UNIVERSAL
DOWNLIGHT | 205



NEW

LED

UNIVERSAL
DOWNLIGHT | 207



NEW

LED

UNIVERSAL
DOWNLIGHT | 208



NEW

LED

UNIVERSAL
DOWNLIGHT | 209



NEW

LED

KADUX | 213



NEW

LED

KADUX | 213



NEW

LED

KADUX | 213



SCKET

KADUX | 214



SCKET

KADUX | 214



SCKET

KADUX | 214



SCKET

KADUX | 215



SCKET

KADUX | 215



LED

MILANDOS 4 | 217



LED

MILANDOS 6 | 217



LED

MILANDOS 8 | 217



LED

HORN MINI | 218



SCKET

HORN | 219



SCKET

HORN | 219



SCKET

HORN | 219



SCKET

HORN | 220



SCKET

HORN | 220



SCKET

HORN | 220



SCKET

HORN-T | 221



LED

HORN MAGNA | 221



LED

SENER 12 | 223



LED

SENER 18 | 223



LED

SENER 24 | 223



LED

SENER 12 | 225



LED

SENER 18 | 225



LED

SENER 24 | 225



LED

VERLUX | 227



LED

VERLUX | 227



LED

DL 126 | 227



SCKET

PIKA | 228



SCKET

PIKA | 228



LED

OCULUS | 229



LED
OCCULDAS 14 | 230



LED
OCCULDAS 23 | 230



LED
CONTONE® | 231



LED
CONTONE® | 231



LED
H-LIGHT | 232



LED
KARPO 30 | 232



SCKET
PLASTRA | 233



SCKET
PLASTRA | 233



LED
DEKLED | 234



SCKET
VARU | 234



SCKET
DOLIX OUT | 235



SCKET
DOLIX OUT | 235



LED
KAMUELA ECO | 236



LED
KAMUELA ECO | 237



LED
KINI | 237



LED
AKALO D83 | 237



LED
FRAME BASIC SET | 238



LED
FRAME BASIC | 238



LED
FRAME BASIC | 238



LED
FRAME CURVE | 239



LED
FRAME CURVE | 239



LED
QUAD FRAME 9 | 240



LED
NOTAPO S | 241



LED
NOTAPO L | 241



LED
DOWNUNDER PUR 80 | 242



LED
DOWNUNDER PUR 150 | 242



LED
MOBALA | 243



LED
WORO | 243



LED
LED PANEL | 243



LED
PATTA-I | 244



LED
PATTA-I | 244



LED
PATTA-I | 245



LED
PATTA-I | 245



LED
PATTA-F | 246



LED
PATTA-F | 247

1007095 + 1007180 205

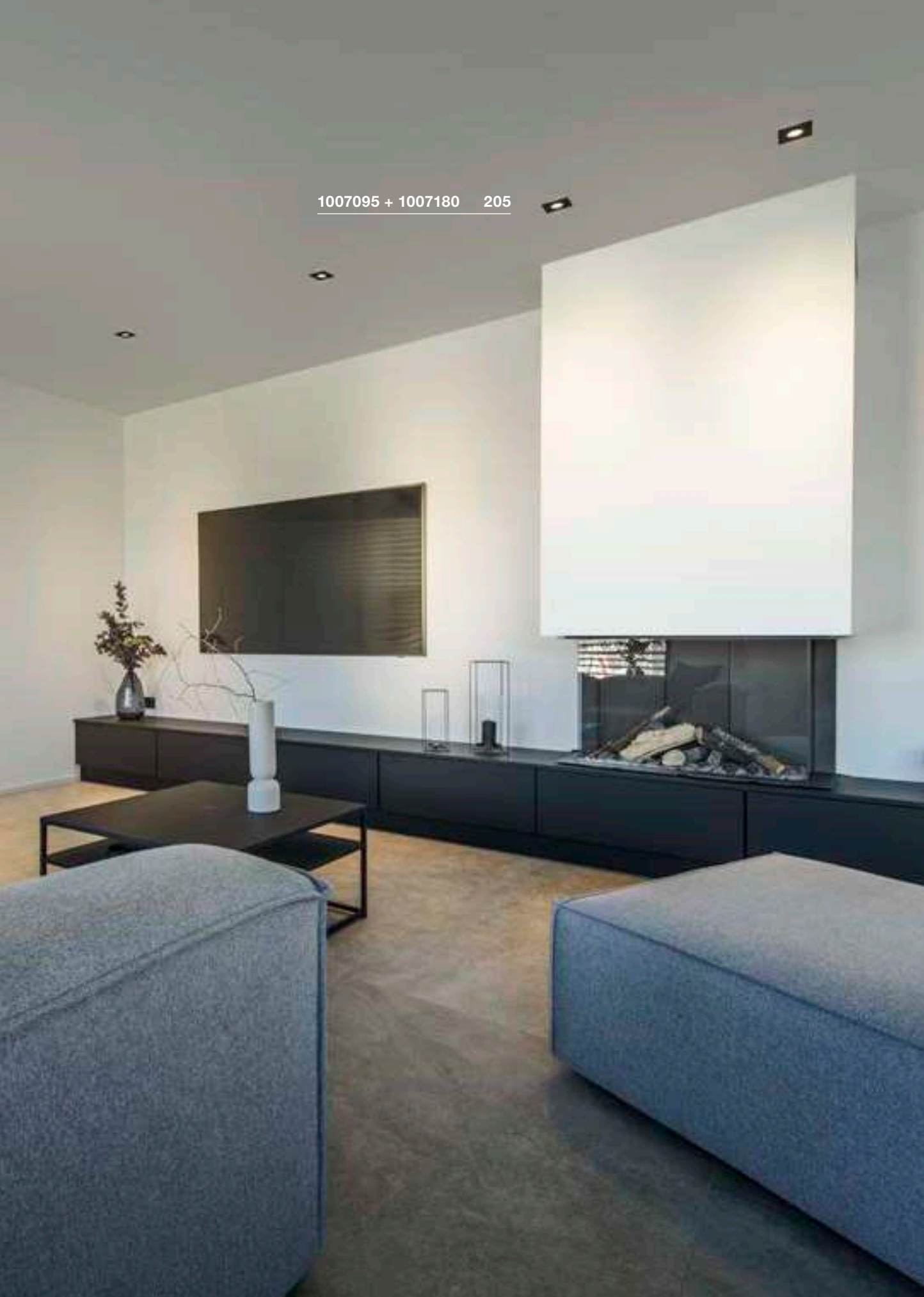



UNIVERSAL DOWNLIGHT Cover, rotondo



NEW

Ø: 8,8 cm
H: 0,35 cm
Materiale: policarbonato (PC)

Versione	Articolo	EUR
● nero	1007096	3,00
○ bianco	1007097	3,00
● oro	1007099	3,50
● oro satinato	1007192	3,50
● cromo spazzolato	1007098	3,50

UNIVERSAL DOWNLIGHT DL, PHASE



NEW

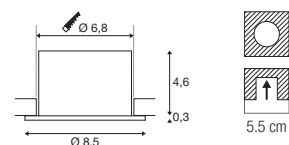

UNIVERSAL DOWNLIGHT Cover, quadrato



NEW

L: 8,8 cm
La: 8,8 cm
H: 0,35 cm
Materiale: policarbonato (PC)

Versione	Articolo	EUR
● nero	1007180	4,00
○ bianco	1007181	4,00
● oro	1007183	4,50
● oro satinato	1007193	4,50
● cromo spazzolato	1007182	4,50



10

220-240V ~50/60Hz | 60/90mA
Potenza: 5W/8W
Materiale: acciaio

- Spessore del materiale della superficie di incasso: 25 mm max.



5W	410lm	2700K
	430lm	3000K
	470lm	4000K
	440lm	6500K
8W	560lm	2700K
	610lm	3000K
	680lm	4000K
	640lm	6500K

Versione	Articolo	EUR
● nero	1007095	26,50

1007090 + 1007184 205



WATCH OUT
MONSTER INSIDE



1002



UNIVERSAL DOWNLIGHT Cover, rotondo



NEW

Ø: 8,8 cm
H: 0,35 cm
Materiale: policarbonato (PC)

Versione	Articolo	EUR
● nero	1007091	3,00
○ bianco	1007092	3,00
● oro	1007094	3,50
● oro satinato	1007191	3,50
● cromo spazzolato	1007093	3,50

UNIVERSAL DOWNLIGHT DL, Move, PHASE



NEW

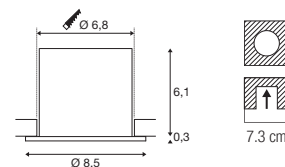

UNIVERSAL DOWNLIGHT Cover, quadrato



NEW

L: 8,8 cm
La: 8,8 cm
H: 0,35 cm
Materiale: policarbonato (PC)

Versione	Articolo	EUR
● nero	1007184	4,00
○ bianco	1007185	4,00
● oro	1007187	4,50
● oro satinato	1007194	4,50
● cromo spazzolato	1007186	4,50

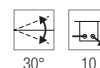

220-240V ~50/60Hz | 60/90mA
Potenza: 5W/8W
Materiale: acciaio

- Spessore del materiale della superficie di incasso: 25 mm max.



5W	410lm	2700K
	610lm	3000K
	680lm	4000K
	640lm	6500K
8W	560lm	2700K
	610lm	3000K
	680lm	4000K
	640lm	6500K

Versione	Articolo	EUR
● nero	1007090	27,00

UNIVERSAL DOWNLIGHT DL with Cover, Multipack

1007271 208

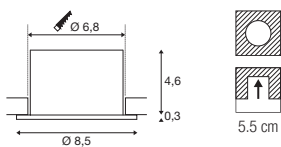

10

220-240V ~50/60Hz | 60/90mA
Potenza: 5W/8W
Materiale: acciaio

- Spessore del materiale della superficie di incasso: 25 mm max.



5W	560lm	2700K
	610lm	3000K
	680lm	4000K
	640lm	6500K
8W	560lm	2700K
	610lm	3000K
	680lm	4000K
	640lm	6500K

Versione	Articolo	EUR
● nero	1007271	354,00
○ bianco	1007272	354,00

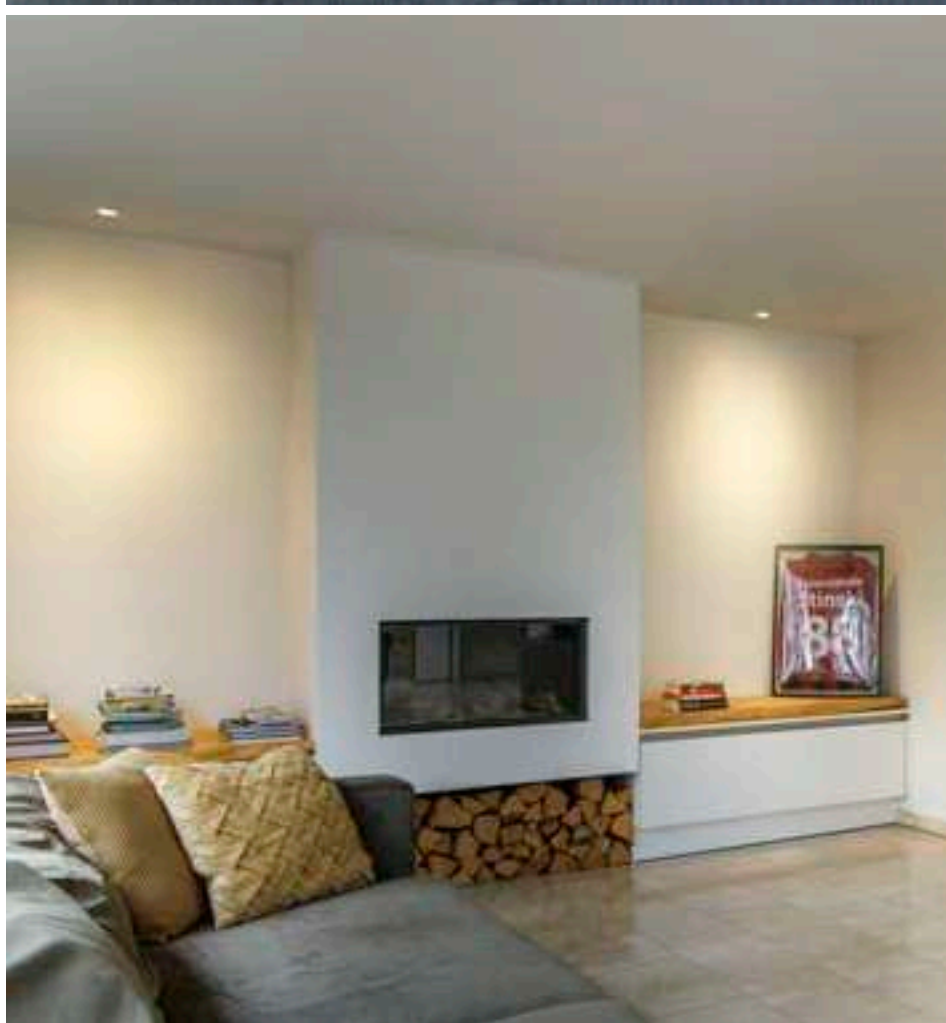
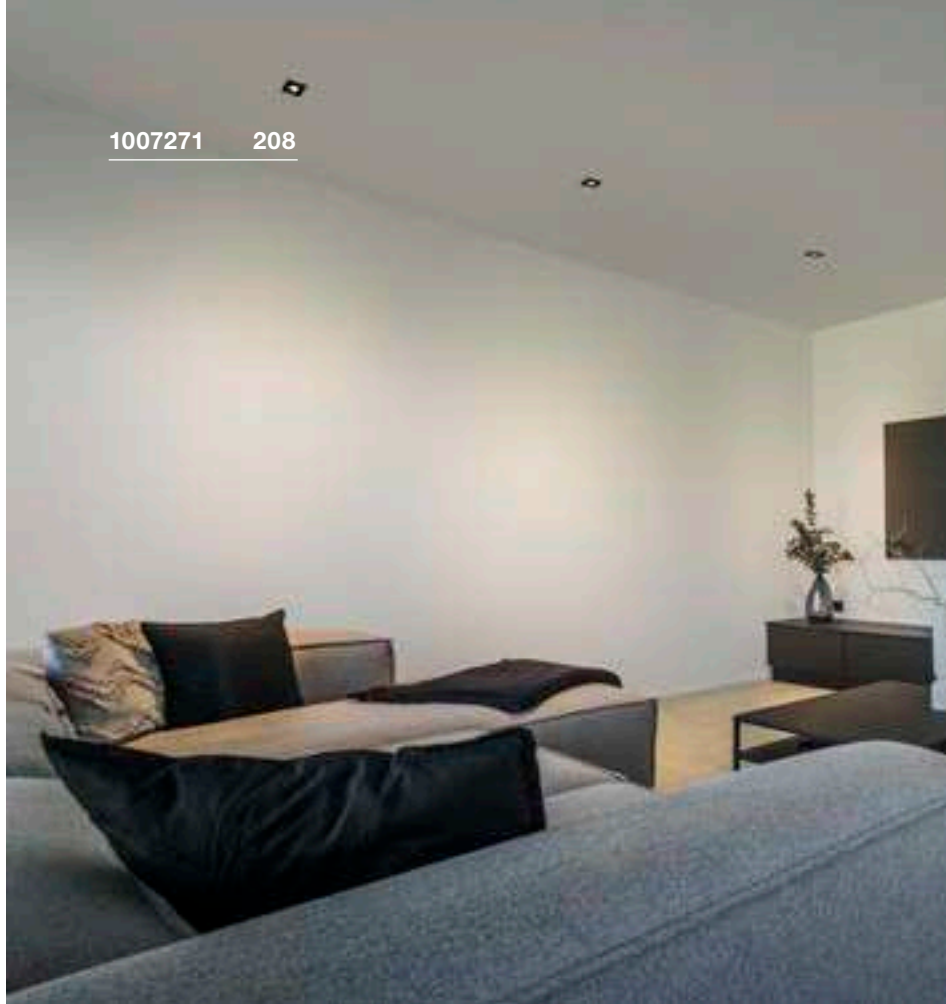



UNIVERSAL DOWNLIGHT DL with Cover, Multipack



NEW

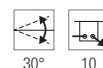
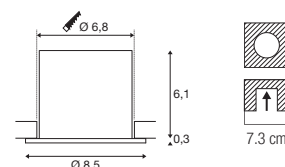

220-240V ~50/60Hz | 60/90mA

Potenza: 5W/8W

Materiale: acciaio

- Spessore del materiale della superficie di incasso: 25 mm max.



5W	410lm	2700K
	610lm	3000K
	680lm	4000K
	640lm	6500K
8W	560lm	2700K
	610lm	3000K
	680lm	4000K
	640lm	6500K

Versione	Articolo	EUR
● nero	1007273	360,00
○ bianco	1007274	360,00

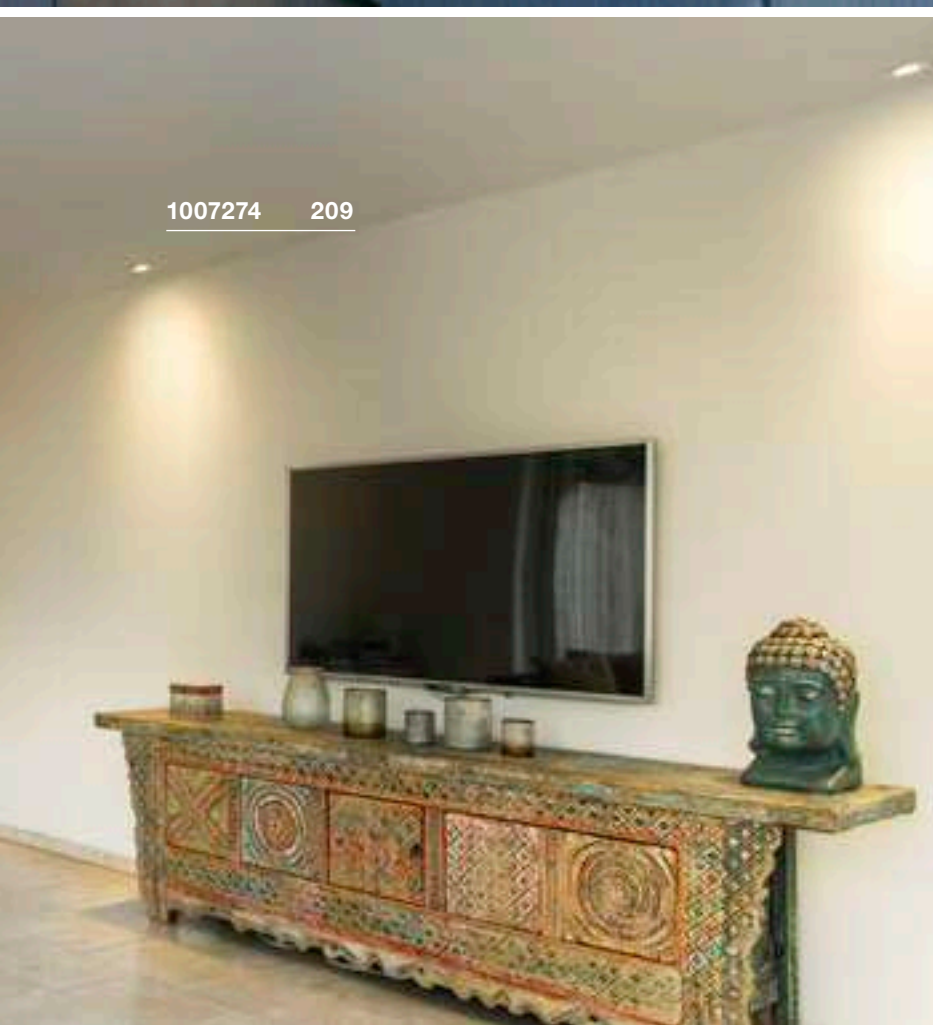

1007274 209

CONFIGURA IL TUO DOWNLIGHT

Estetica semplice, caratteristiche top. L'UNIVERSAL DOWNLIGHT, disponibile nella versione fissa e orientabile, è un apparecchio da incasso che produce una illuminazione mirata con fascio di 36°. Il colore della luce (2700/3000/4000/6500K) e la potenza (5W, 8W) possono essere selezionati durante l'installazione tramite gli interruttori CCT. La resa fedele dei colori è ottenuta grazie all'elevato CRI superiore a 90. Il box di connessione rapida lo rende facile e veloce da installare. Completa il tuo UNIVERSAL DOWNLIGHT con gli anelli frontali decorativi disponibili separatamente rotondi e quadrati nelle finiture nero, bianco, cromo spazzolato, oro, oro satinato.

SCEGLI LE OPZIONI

- 1 Versione (fissa, orientabile)
- 2 Copertura (nero, bianco, cromo spazzolato, oro, oro satinato)
- 3 Temperatura del colore (2700, 3000, 4000, 6500 K)
- 4 Potenza: (5W, 8W)



FATTO!

UNIVERSAL DOWNLIGHT

UNIVERSAL DOWNLIGHT



Cornice quadrata o rotonda per versione fissa

UNIVERSAL DOWNLIGHT MOVE



Cornice quadrata o rotonda per versione orientabile

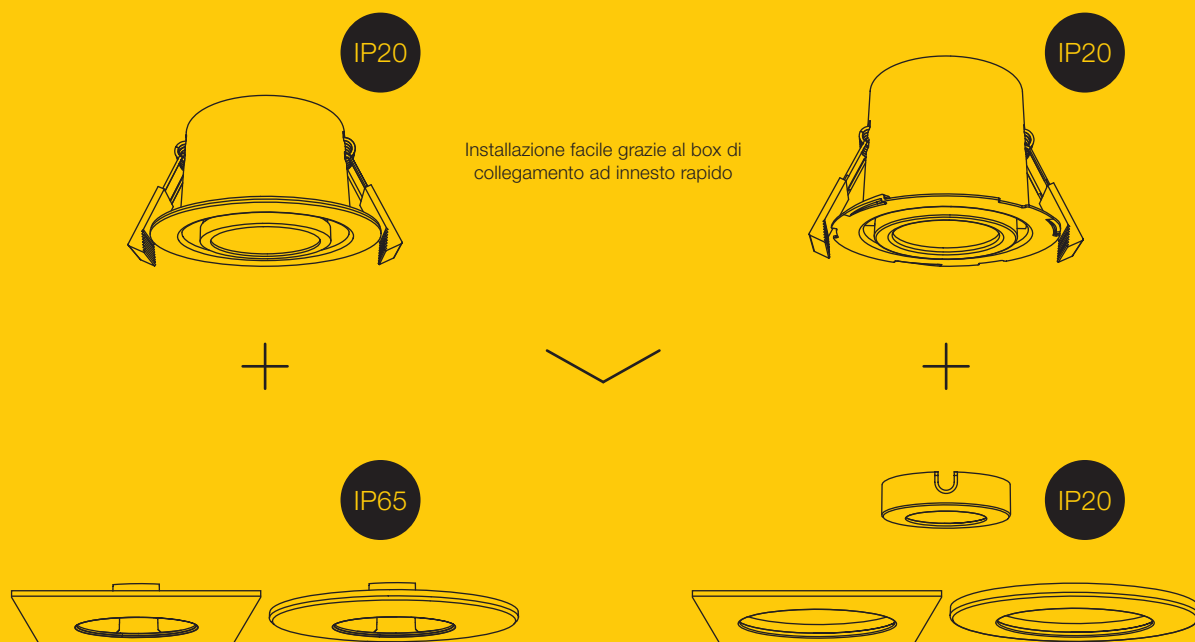

Anelli frontali intercambiabili rotondi o quadrati nelle finiture nero, bianco, cromo spazzolato, oro, oro satinato

2700K 3000K 4000K 6500K Temperatura del colore selezionabile 2700K 3000K 4000K 6500K

Potenza selezionabile 5W/8W

Elevata qualità della luce grazie alla resa cromatica CRI>90

1007560 213



1007567 213



1007551 213

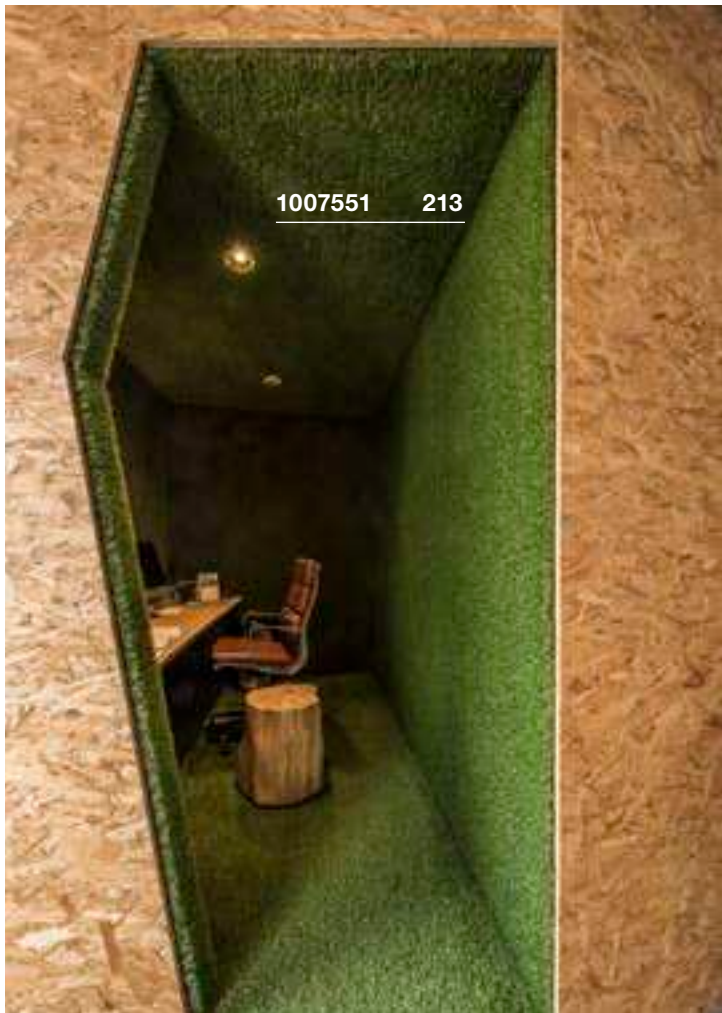



KADUX DL, single, PHASE

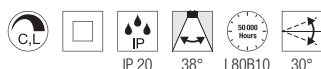
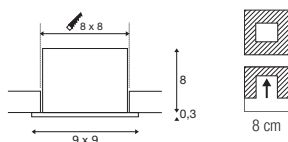

220-240V ~50/60Hz | 350mA
Potenza assorbita: 7,5W
Materiale: alluminio/acciaio

- Clip di fissaggio
- Spessore del materiale della superficie di incasso: 30 mm max



Down 770lm | 3000K

Versione	Articolo	EUR
● nero	1007551	85,00
○ bianco	1007552	85,00

KADUX DL, double, PHASE

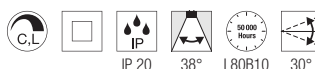
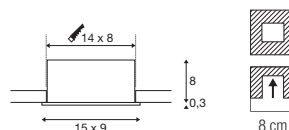

220-240V ~50/60Hz | 350mA
Potenza assorbita: 14W
Materiale: alluminio/acciaio

- Clip di fissaggio
- Spessore del materiale della superficie di incasso: 30 mm max



Down 1510lm | 3000K

Versione	Articolo	EUR
● nero	1007559	160,00
○ bianco	1007560	160,00

KADUX DL, triple, PHASE

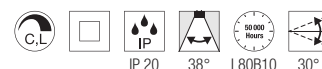
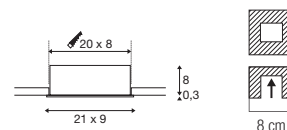

220-240V ~50/60Hz | 350mA
Potenza assorbita: 20W
Materiale: alluminio/acciaio

- Clip di fissaggio
- Spessore del materiale della superficie di incasso: 30 mm max



Down 2310lm | 3000K

Versione	Articolo	EUR
● nero	1007567	211,00
○ bianco	1007568	211,00

KADUX
EL, single, QPAR51

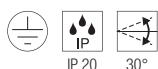
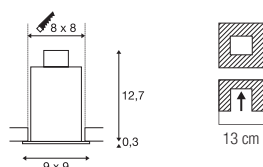

220-240V ~50/60Hz
Materiale: alluminio/acciaio

- Clip di fissaggio
- Spessore del materiale della superficie di incasso: 30 mm max



Attacco: 1xGU10

Versione	Articolo	EUR
● nero	115510	33,25
○ bianco	115511	33,25

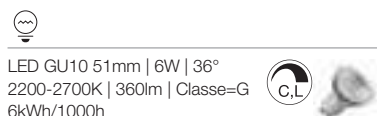

Articolo: 1005273 | 9,99 EUR

KADUX
EL, double, QPAR51

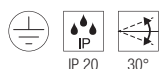
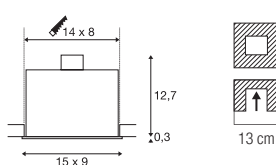

220-240V ~50/60Hz
Materiale: alluminio/acciaio

- Clip di fissaggio
- Spessore del materiale della superficie di incasso: 30 mm max



Attacco: 2xGU10

Versione	Articolo	EUR
● nero	115520	61,00
○ bianco	115521	61,00

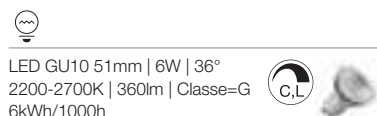

Articolo: 1005273 | 9,99 EUR

KADUX
EL, triple, QPAR51

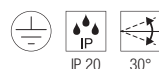
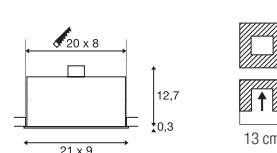

220-240V ~50/60Hz
Materiale: alluminio/acciaio

- Clip di fissaggio
- Spessore del materiale della superficie di incasso: 30 mm max



Attacco: 3xGU10

Versione	Articolo	EUR
● nero	115530	83,00
○ bianco	115531	83,00

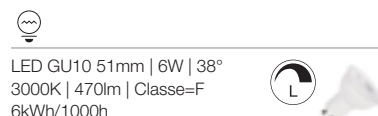

Articolo: 1005079 | 7,50 EUR



115550

215

KADUX
EL, single, QPAR111

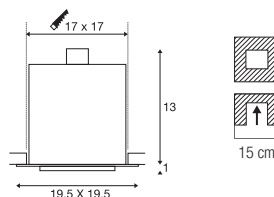

KADUX
EL, double, QPAR111

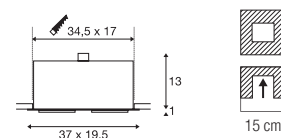

115531

214

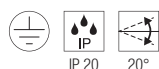

220-240V ~50/60Hz
Materiale: alluminio/acciaio

- Clip di fissaggio
- Spessore del materiale della superficie di incasso: 25 mm max.



Attacco: 1xGU10

Versione	Articolo	EUR
● nero	115540	107,00
○ bianco	115541	107,00



220-240V ~50/60Hz
Materiale: alluminio/acciaio

- Clip di fissaggio
- Spessore del materiale della superficie di incasso: 25 mm max.



Attacco: 2xGU10

Versione	Articolo	EUR
● nero	115550	164,00
○ bianco	115551	164,00



QPAR111 | 8W | 38°
2700K | 680lm | Classe=F
8kWh/1000h



Articolo: 1005274 | 30,75 EUR



QPAR111 | 8W | 38°
2700K | 680lm | Classe=F
8kWh/1000h



Articolo: 1005274 | 30,75 EUR

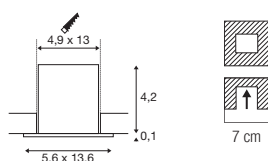

MILANDOS 4
DL

700mA
Potenza assorbita: 8W
Materiale: alluminio/policarbonato (PC)

- Clip di fissaggio
- Spessore del materiale della superficie di incasso: max. 40 mm



Down	510lm 2700K	2700K
	520lm 3000K	3000K
	650lm 3000K	

Versione	Articolo	EUR
● nero		
510lm 2700K	1005407	190,00
● nero		
520lm 3000K	1005408	190,00
○ bianco		
650lm 3000K	1005410	190,00

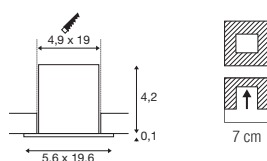

Articolo	Articolo	EUR
Driver LED 20W 250-700mA 1-10V/ dimmerabile DALI con serracavo		
○ bianco	1002423	85,00
Driver LED 10W 700mA dimmerabile con serracavo		
○ bianco	1007213	35,00

MILANDOS 6
DL

700mA
Potenza assorbita: 12W
Materiale: alluminio/policarbonato (PC)

- Clip di fissaggio
- Spessore del materiale della superficie di incasso: max. 40 mm



Down	770lm 2700K	2700K
	780lm 3000K	3000K
	980lm 3000K	

Versione	Articolo	EUR
● nero		
770lm 2700K	1005415	212,00
● nero		
780lm 3000K	1005416	212,00
○ bianco		
980lm 3000K	1005418	212,00

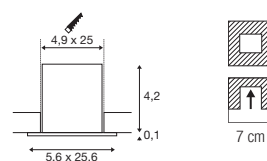

Articolo	Articolo	EUR
Driver LED 15W 700mA con serracavo		
○ bianco	1006202	34,00
Driver LED 20W 700mA dimmerabile con serracavo		
○ bianco	1002423	85,00

MILANDOS 8
DL

700mA
Potenza assorbita: 16W
Materiale: alluminio/policarbonato (PC)

- Clip di fissaggio
- Spessore del materiale della superficie di incasso: max. 40 mm



Down	1030lm 2700K	2700K
	1040lm 3000K	3000K

Versione	Articolo	EUR
● nero		
1030lm 2700K	1005423	259,00
● nero		
1040lm 3000K	1005424	259,00



Articolo	Articolo	EUR
Driver LED 20W 250-700mA 1-10V/ dimmerabile DALI con serracavo		
○ bianco	1002423	85,00
Driver LED 20W 700mA dimmerabile con serracavo		
○ bianco	1006202	34,00

HORN MINI EL

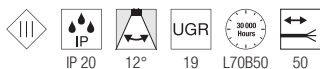
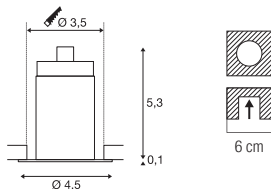

350mA
Potenza assorbita: 1,2W
Materiale: alluminio/policarbonato (PC)

- Clip di fissaggio
- Spina AMP incl.
- Temperatura della luce più calda utilizzando la versione con il riflettore oro
- Driver escluso



Down 70lm | 2900K
3000K

Versione	Articolo	EUR
● nero 3000K	1000915	40,25
●● nero/oro 2900K	1000917	43,75
○ bianco 3000K	1000914	40,25



Articolo	Articolo	EUR
Prolunga cavi 1m		
○ bianco	111861	7,75
Driver Led 3W 350mA presa AMP inclusa		
○ bianco	1007270	19,80
Presa multipla a 3 uscite		
● nero	111850	13,40

113141 219



1000914 218





HORN
DL, single, QPAR51

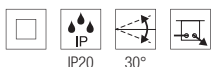
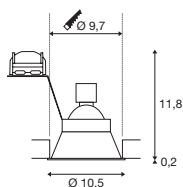

220-240V ~50/60Hz
Materiale: alluminio

- Clip di fissaggio
- Spessore del materiale della superficie di incasso: 30 mm max



Attacco: 1xGU10

Versione	Articolo	EUR
● nero	113140	52,00
○ bianco	113141	52,00



LED GU10 51mm | 6W | 38°
2700K | 450lm | Classe=F
6kWh/1000h



Articolo: 1005077 | 7,50 EUR

HORN
DL, double, QPAR51

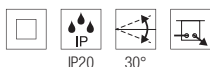
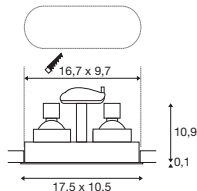

220-240V ~50/60Hz
Materiale: alluminio

- Clip di fissaggio
- Spessore del materiale della superficie di incasso: 30 mm max



Attacco: 2xGU10

Versione	Articolo	EUR
● nero	1006121	75,00
○ bianco	1006122	75,00



LED GU10 51mm | 6W | 38°
2700K | 450lm | Classe=F
6kWh/1000h



Articolo: 1005077 | 7,50 EUR

HORN
DL, single, asimmetrica, QPAR51

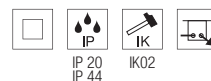
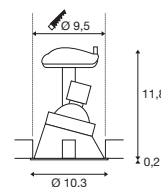

220-240V ~50/60Hz
Materiale: alluminio

- Clip di fissaggio
- Spessore del materiale della superficie di incasso: 30 mm max



Attacco: 1xGU10

Versione	Articolo	EUR
● nero	113150	57,00
○ bianco	113151	57,00



LED GU10 51mm | 6W | 36°
2200-2700K | 360lm | Classe=G
6kWh/1000h



Articolo: 1005273 | 9,99 EUR

HORN
DL, single, QPAR51

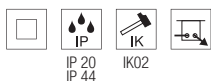
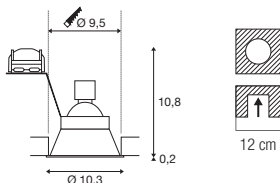

220-240V ~50/60Hz
Materiale: alluminio

- Clip di fissaggio
- Spessore del materiale della superficie di incasso: 25 mm max.



Attacco: 1xGU10

Versione	Articolo	EUR
● nero	113160	52,00
○ bianco	113161	52,00



LED GU10 51mm | 6W | 38°
2700K | 450lm | Classe=F
6kWh/1000h



Articolo: 1005077 | 7,50 EUR

HORN
EL, single, QPAR51

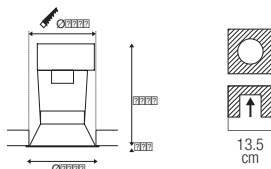

220-240V ~50/60Hz
Materiale: acciaio

- Clip di fissaggio
- Spessore del materiale della superficie di incasso: 45 mm max



Attacco: 1xGU10 max. Ø: 5,1 cm | L: 5,4 cm

Versione	Articolo	EUR
● nero	112910	27,50
○ bianco	112911	27,50



LED GU10 51mm | 6W | 38°
2700K | 450lm | Classe=F
6kWh/1000h



Articolo: 1005077 | 7,50 EUR

HORN
DL, GU10, testato Blower Door

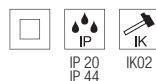
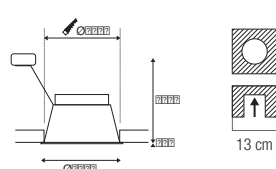

220-240V ~50/60Hz
Materiale: alluminio

- Il downlight soddisfa i requisiti RT2012
- Spessore del materiale della superficie di incasso: 30 mm max



Attacco: 1xGU10

Versione	Articolo	EUR
● nero	1005435	26,50
○ bianco	1005436	26,50



LED GU10 51mm | 6W | 38°
2700K | 450lm | Classe=F
6kWh/1000h



Articolo: 1005077 | 7,50 EUR

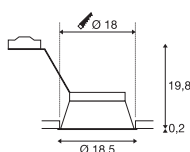
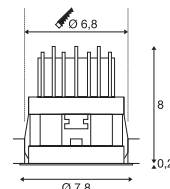

112911 220

HORN-T
EL, QPAR111HORN MAGNA
EL

1002592 221

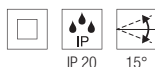
220-240V ~50/60Hz
Materiale: acciaio

- Clip di fissaggio
- Spessore del materiale della superficie di incasso: 30 mm max



Attacco: 1xGU10

Versione	Articolo	EUR
● nero	113170	69,00
○ bianco	113171	69,00

QPAR111 | 8W | 38°
2700K | 680lm | Classe=F
8kWh/1000h

Articolo: 1005274 | 30,75 EUR

500mA
Potenza assorbita: 9W
Materiale: alluminio/polycarbonato (PC)

- Temperatura della luce più calda utilizzando la versione con il riflettore oro
- Clip di fissaggio
- Spessore del materiale della superficie di incasso: 25 mm max.
- Cavo con terminale aperto

Down
445lm | 3000K
550lm |
570lm

Versione	Articolo	EUR
● nero		
445lm	1002592	75,00
● nero/oro		
570lm	1002594	78,00
○ bianco		
550lm	1002591	75,00



Articolo	Articolo	EUR
Driver LED 20W 350mA/500mA PHASE		
○ bianco	1007227	40,00
Driver LED 25W 150-700mA dimmerabile DALI		
○ bianco	1007229	70,00
Driver LED 21W 500mA con serracavo		
○ bianco	1007226	30,00

1003010 223





SENER 12 EL, rotondo

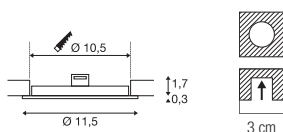

200mA
Potenza assorbita: 6,4W
Materiale: alluminio

- Clip di fissaggio
- Spessore del materiale della superficie di incasso: 15 mm max.



Down 420lm | 3000K
470lm | 4000K

Versione	Articolo	EUR
○ bianco 420lm 3000K 6.4W	1003008	29,50
○ bianco 470lm 4000K 6W	1004694	29,50



Articolo	Articolo	EUR
Driver LED 25W 150-700mA dimmerabile DALI		
○ bianco	1007229	70,00
Driver LED 10W 200mA dimmerabile con serracavo		
○ bianco	1007215	35,00

SENER 18 EL, rotondo

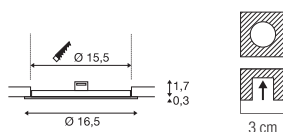

350mA
Potenza assorbita: 10W
Materiale: alluminio

- Clip di fissaggio
- Spessore del materiale della superficie di incasso: 15 mm max.



Down 880lm | 3000K
990lm | 4000K

Versione	Articolo	EUR
○ bianco 880lm 3000K 10W	1003009	34,00
○ bianco 990lm 4000K 12W	1004695	34,00



Articolo	Articolo	EUR
Driver LED 20W 350mA dimmerabile		
○ bianco	1007228	40,00
Driver LED 25W 150-700mA dimmerabile DALI		
○ bianco	1007229	70,00

SENER 24 EL, rotondo

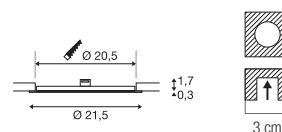

500mA
Potenza assorbita: 13W
Materiale: alluminio

- Clip di fissaggio
- Spessore del materiale della superficie di incasso: 15 mm max.



Down 1200lm | 3000K
1300lm | 4000K

Versione	Articolo	EUR
○ bianco 1200lm 3000K	1003010	45,25
○ bianco 1300lm 4000K	1004696	45,25



Articolo	Articolo	EUR
Driver LED 20W 350mA/500mA PHASE		
○ bianco	1007227	40,00
Driver LED 25W 150-700mA dimmerabile DALI		
○ bianco	1007229	70,00
Driver LED 21W 500mA con serracavo		
○ bianco	1007226	30,00

1003011 225

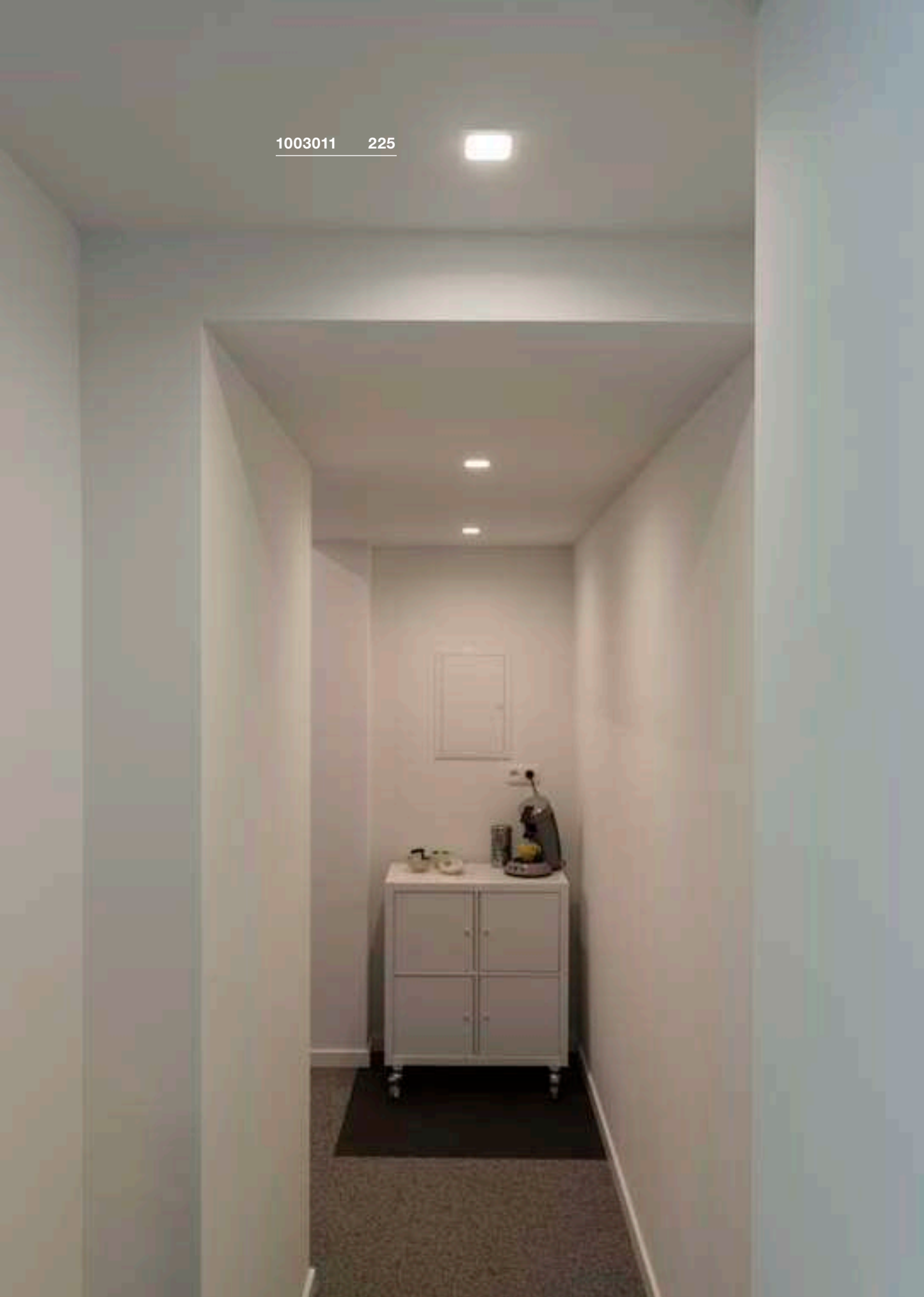



SENER 12 EL, quadrato

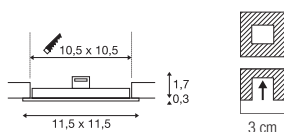

200mA
Potenza assorbita: 6,4W
Materiale: alluminio

- Clip di fissaggio
- Spessore del materiale della superficie di incasso: 15 mm max.



Down 440lm | 3000K | 4000K

Versione	Articolo	EUR
○ bianco 3000K	1003011	29,50
○ bianco 4000K	1004697	29,50



Articolo	Articolo	EUR
Driver LED 25W 150-700mA dimmerabile DALI		
○ bianco	1007229	70,00
Driver LED 10W 200mA dimmerabile		
○ bianco	1007215	35,00

SENER 18 EL, quadrato

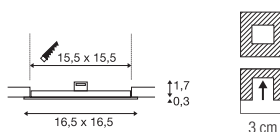

350mA
Potenza assorbita: 10W
Materiale: alluminio

- Clip di fissaggio
- Spessore del materiale della superficie di incasso: 15 mm max.



Down 880lm | 4000K | 900lm | 3000K

Versione	Articolo	EUR
○ bianco 900lm 3000K 10W	1003012	34,00
○ bianco 880lm 4000K 12W	1004698	34,00



Articolo	Articolo	EUR
Driver LED 20W 350mA dimmerabile		
○ bianco	1007228	40,00
Driver LED 25W 150-700mA dimmerabile DALI		
○ bianco	1007229	70,00

SENER 24 EL, quadrato

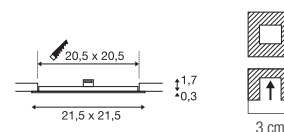

500mA
Potenza assorbita: 13W
Materiale: alluminio

- Clip di fissaggio
- Spessore del materiale della superficie di incasso: 15 mm max.



Down 1100lm | 3000K | 1240lm | 4000K

Versione	Articolo	EUR
○ bianco 1100lm 3000K	1003013	45,25
○ bianco 1240lm 4000K	1004699	45,25



Articolo	Articolo	EUR
Driver LED 20W 350-500mA PHASE		
○ bianco	1007227	40,00
Driver LED 25W 150-700mA dimmerabile DALI		
○ bianco	1007229	70,00
Driver LED 21W 500mA		
○ bianco	1007226	30,00

112682 227



112222 227



112225 227





VERLUX
EL, quadrato, PHASE

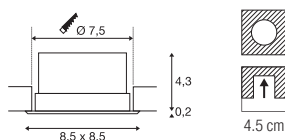

220-240V ~50/60Hz | 500mA
Potenza assorbita: 11W
Materiale: alluminio/plastica

- Clip di fissaggio
- Spessore del materiale della superficie di incasso: 20 mm max



Down 940lm | 3000K

Versione	Articolo	EUR
○ bianco	112682	90,00

VERLUX
EL, quadrato, PHASE

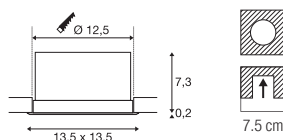

220-240V ~50/60Hz | 500mA
Potenza assorbita: 22W
Materiale: alluminio/plastica

- Clip di fissaggio
- Spessore del materiale della superficie di incasso: 25 mm max.



Down 1800lm | 3000K

Versione	Articolo	EUR
○ bianco	112692	133,00

DL 126
EL

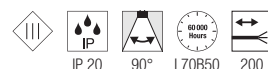
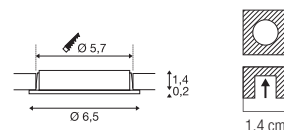

12V DC
Potenza assorbita: 2,8W
Materiale: alluminio/plastica

- Clip di fissaggio



Down 170lm | 3000K

Versione	Articolo	EUR
○ bianco	112221	36,25
● cromo	112222	42,25
● grigio	112225	36,25



Articolo	Articolo	EUR
Alimentatore LED 12/20W 24V		
○ bianco	1005381	39,50
Alimentatore LED 15W 12V		
○ bianco	1005444	29,50

PIKA
DL, rotondo, QPAR51, fisso

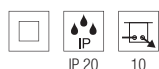
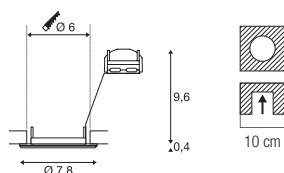

220-240V ~50/60Hz
Materiale: alluminio

- Clip di fissaggio
- Spessore del materiale della superficie di incasso: 13 mm max.



Attacco: 1xGU10

Versione	Articolo	EUR
○ bianco	1000714	12,70
● ottone	1000716	18,20
● cromo	1000715	18,20
● grigio	1000717	12,70

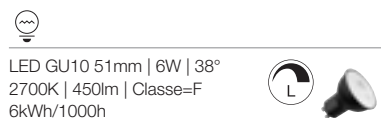

Articolo: 1005077 | 7,50 EUR

PIKA
DL, rotondo, QPAR51, orientabile

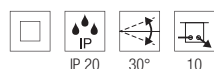
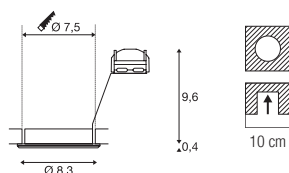

220-240V ~50/60Hz
Materiale: alluminio

- Clip di fissaggio
- Spessore del materiale della superficie di incasso: 15 mm max.



Attacco: 1xGU10

Versione	Articolo	EUR
○ bianco	1000718	18,20
● ottone	1000720	20,50
● cromo	1000719	20,50
● grigio	1000721	18,20

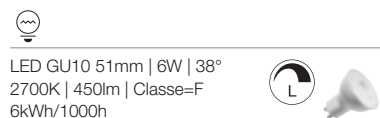

Articolo: 1005075 | 7,50 EUR

1000719 228





OCULUS CL, Move, PHASE

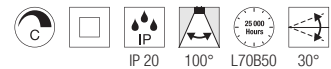
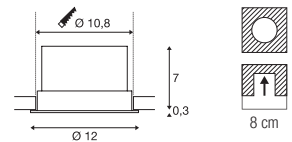

220-240V ~50/60Hz | 250mA

Potenza assorbita: 11W

Materiale: alluminio/vetro

- Clip di fissaggio
- Inclusa lente smerigliata aggiuntiva
- Spessore del materiale della superficie di incasso: 20 mm max



Down 36lm | 2000K - 780lm | 3000K

Versione	Articolo	EUR
● nero	1004668	209,00
○ bianco	1004669	209,00

1004669 229

OCCULDAS 14
EL, indiretto, PHASE

OCCULDAS 23
EL, indiretto, PHASE

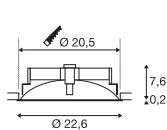
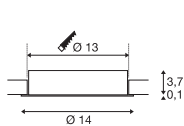

220-240V ~50/60Hz | 350mA
Potenza assorbita: 15W
Materiale: alluminio/acciaio

- Clip di fissaggio
- Spessore del materiale della superficie di incasso: 20 mm max



Down 810lm | 3000K

Versione	Articolo	EUR
○ bianco	117331	167,00



220-240V ~50/60Hz | 700mA
Potenza assorbita: 23W
Materiale: alluminio/acciaio

- Clip di fissaggio
- Spessore del materiale della superficie di incasso: 30 mm max



Down 1500lm | 3000K

Versione	Articolo	EUR
○ bianco	117311	308,00

117311

230





CONTONE®
DL, rotondo, regolabile, PHASE

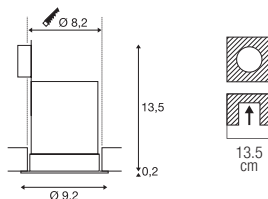

CONTONE®
DL, rotondo, fisso, PHASE

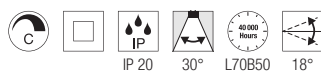
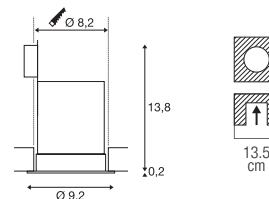

220-240V ~50/60Hz | 350mA
Potenza assorbita: 15W
Materiale: alluminio

- Clip di fissaggio
- Spessore del materiale della superficie di incasso: 25 mm max.



Down 1000lm | 2000-3000K

Versione	Articolo	EUR
○ bianco	161271	103,00

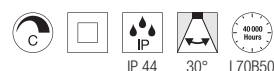

220-240V ~50/60Hz | 350mA
Potenza assorbita: 15W
Materiale: alluminio

- Clip di fissaggio
- Spessore del materiale della superficie di incasso: 25 mm max.



Down 1000lm | 2000-3000K

Versione	Articolo	EUR
○ bianco	161291	103,00



161271 231

H-LIGHT
DL, rotondo, PHASE

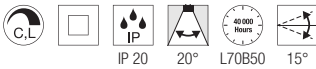
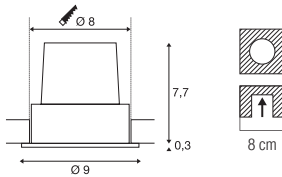

220-240V ~50/60Hz | 500mA
Potenza assorbita: 11W
Materiale: alluminio

- Clip di fissaggio
- Spessore del materiale della superficie di incasso: 30 mm max



Down 265lm | 2700K

Versione	Articolo	EUR
● nero	114480	91,00
○ bianco	114481	91,00

KARPO 30
EL

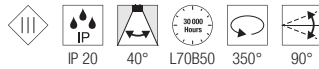
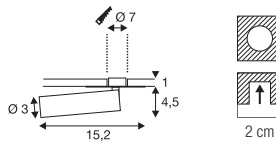

500mA
Potenza assorbita: 7,5W
Materiale: alluminio/acciaio

- Spessore del materiale della superficie di incasso: 12 mm max. In caso di utilizzo di più apparecchi, collegare in serie.
- Clip di fissaggio
- Spina AMP incl.
- Spessore del materiale della superficie di incasso: max. 12 mm



Down 450lm | 470lm | 3000K

Versione	Articolo	EUR
● nero		
450lm	152380	125,00
○ bianco		
470lm	152381	125,00



Articolo	Articolo	EUR
Driver LED 20W 350mA/500mA PHASE		
○ bianco	1007227	40,00
Driver LED 25W 150-700mA dimmerabile DALI		
○ bianco	1007229	70,00
Driver LED 21W 500mA con serracavo		
○ bianco	1007226	30,00





148071 233

PLASTRA

RL, rotondo, QPAR51

PLASTRA

RL, quadrato, QPAR51

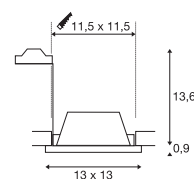
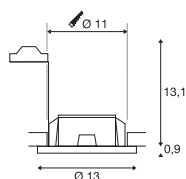

IP 20

220-240V ~50/60Hz
Materiale: gesso/acciaio

- Clip di fissaggio
- Spessore del materiale della superficie di incasso: 25 mm max.



IP 20

220-240V ~50/60Hz
Materiale: gesso/acciaio

- Clip di fissaggio
- Spessore del materiale della superficie di incasso: 30 mm max



Attacco: 1xGU10

Versione	Articolo	EUR
○ bianco	148070	42,25



LED GU10 51mm | 6W | 36°
2200-2700K | 360lm | Classe=G
6kWh/1000h



Articolo: 1005273 | 9,99 EUR



Attacco: 1xGU10

Versione	Articolo	EUR
○ bianco	148071	42,25



LED GU10 51mm | 6W | 38°
2700K | 450lm | Classe=F
6kWh/1000h



Articolo: 1005076 | 7,50 EUR

DEKLED
EL

VARU
EL, QPAR51

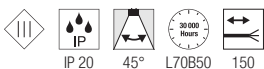
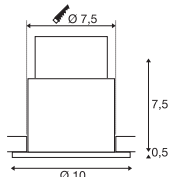
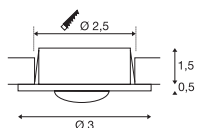

350mA
Potenza assorbita: 1W
Materiale: alluminio/polycarbonato (PC)

- Clip di fissaggio



Down 60lm | 3000K

Versione	Articolo	EUR
● grigio	112242	31,25



Articolo	Articolo	EUR
○ bianco	1002791	28,50

Driver LED 350mA/6W dimmerabile

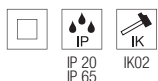

220-240V ~50/60Hz
Materiale: alluminio/vetro

- Clip di fissaggio
- Spessore del materiale della superficie di incasso: 15 mm max.



Attacco: 1xGU10 max. Ø: 5,1 cm

Versione	Articolo	EUR
● nero	1001930	41,00
○ bianco	1001931	41,00



LED GU10 51mm | 6W | 38°
2700K | 450lm | Classe=F
6kWh/1000h

Articolo: 1005077 | 7,50 EUR



1001931 234



1001931 234





1001165 235



DOLIX OUT
EL, rotondo, QPAR51

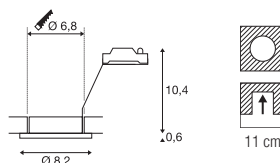

DOLIX OUT
EL, quadrato, QPAR51

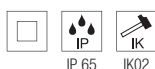
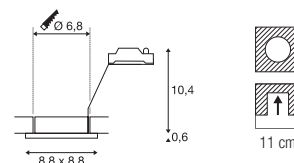

220-240V ~50/60Hz
Materiale: alluminio/vetro

- Clip di fissaggio
- Spessore del materiale della superficie di incasso: 20 mm max



Attacco: 1xGU10

Versione	Articolo	EUR
○ bianco	1001165	35,50
● argento	1001168	39,50
● cromo	1001166	39,50
● grigio	1001167	35,50



LED GU10 51mm | 6W | 36°
2200-2700K | 360lm | Classe=G
6kWh/1000h



Articolo: 1005273 | 9,99 EUR

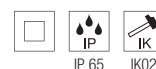

220-240V ~50/60Hz
Materiale: alluminio/vetro

- Clip di fissaggio
- Spessore del materiale della superficie di incasso: 20 mm max



Attacco: 1xGU10

Versione	Articolo	EUR
○ bianco	1001169	35,50
● argento	1001172	39,50
● grigio	1001171	35,50



LED GU10 51mm | 6W | 36°
2200-2700K | 360lm | Classe=G
6kWh/1000h



Articolo: 1005273 | 9,99 EUR



1001166 235

1001015 236



KAMUELA ECO
EL, rotondo, PHASE

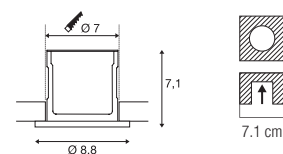

1001017 237

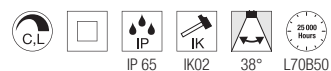

220-240V ~50Hz
Potenza assorbita: 6W
Materiale: alluminio/plastica

- Clip di fissaggio
- Spessore del materiale della superficie di incasso: max. 40 mm
- Resistente al fuoco per min. 90 minuti secondo BS 476-21



CRI
84

Down

500lm | 3000K

Versione	Articolo	EUR
● nero	1001015	35,50
○ bianco	1001016	35,50



KAMUELA ECO EL, rotondo, PHASE

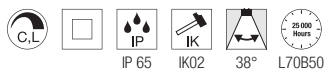
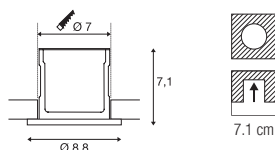

220-240V ~50Hz
Potenza assorbita: 6W
Materiale: alluminio/plastica

- Clip di fissaggio
- Spessore del materiale della superficie di incasso: max. 40 mm
- Resistente al fuoco per min. 90 minuti secondo BS 476-21



Down 530lm | 4000K

Versione	Articolo	EUR
● nero	1001017	35,50
○ bianco	1001018	35,50

KINI EL, PHASE

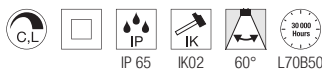
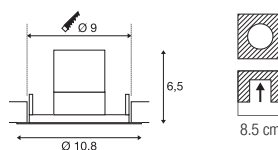

220-240V ~50/60Hz | 260mA
Potenza assorbita: 12W
Materiale: alluminio/policarbonato (PC)

- Clip di fissaggio
- Spessore del materiale della superficie di incasso: 20 mm max
- Orientabile 30°



Down 850lm | 3000K

Versione	Articolo	EUR
○ bianco	1000833	103,00

AKALO D83 EL

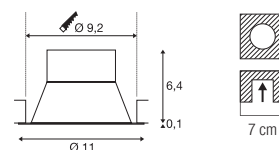

220-240V ~50/60Hz | 120mA
Potenza assorbita: 9W
Materiale: alluminio/policarbonato (PC)

- Clip di fissaggio
- Spessore del materiale della superficie di incasso: 20 mm max



800lm | 3000K | 880lm | 4000K | 850lm | 5700K

Versione	Articolo	EUR
○ bianco	1001264	40,25

FRAME BASIC SET RL

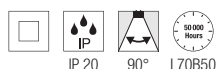
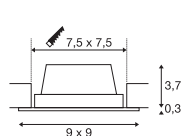

220-240V ~50/60Hz | 350mA
Potenza assorbita: 8,3W
Materiale: alluminio/acrilico

- Clip di fissaggio
- Spessore del materiale della superficie di incasso: 20 mm max



Down 600lm | 3000K

Versione	Articolo	EUR
● nero	112720	54,00
○ bianco	112721	54,00

FRAME BASIC RL, HV

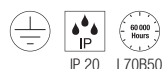
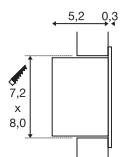

100-240V ~50/60Hz | 350mA
Potenza assorbita: 3W
Materiale: alluminio

- Spessore del materiale della superficie di incasso: 30 mm max



Down 170lm | 2700K

Versione	Articolo	EUR
○ bianco	1000576	71,00
● grigio	1000577	71,00



Articolo	Articolo	EUR
Scatola da incasso		
● nero	112781	10,90
Telaio sotto intonaco		
● oro	112780	6,35

FRAME BASIC

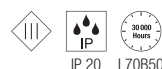
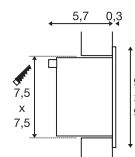

350mA
Potenza assorbita: 1W
Materiale: alluminio/vetro

- In caso di utilizzo di più apparecchi, collegare in serie.
- Spina AMP incl.
- Spessore del materiale della superficie di incasso: 30 mm max



Down 40lm | 3000K

Versione	Articolo	EUR
○ bianco	113262	40,00
● grigio	111262	40,00



Articolo	Articolo	EUR
Scatola da incasso		
● nero	112781	10,90
Prolunga cavi 1m		
○ bianco	111861	7,75
Driver Led 3W 350mA presa AMP inclusa		
○ bianco	1007270	19,80
Presa multipla a 3 uscite		
● nero	111850	13,40
Telaio sotto intonaco		
● oro	112780	6,35



FRAME CURVE EL

FRAME CURVE EL

1000575 239

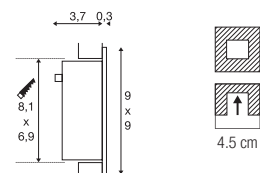
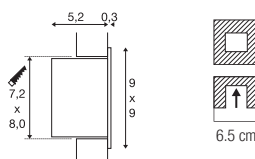

IP 20 L70B50

100-240V ~50/60Hz | 350mA
Potenza assorbita: 3W
Materiale: alluminio

- Clip di fissaggio
- Spessore del materiale della superficie di incasso: 30 mm max



Down 140lm | 2700K

Versione	Articolo	EUR
○ bianco	1000574	77,00
● grigio	1000575	77,00



Articolo	Articolo	EUR
Scatola da incasso		
● nero	112781	10,90
Telaio sotto intonaco		
● oro	112780	6,35

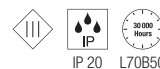

IP 20 L70B50

350mA
Potenza assorbita: 1W
Materiale: alluminio

- In caso di utilizzo di più apparecchi, collegare in serie.
- Clip di fissaggio
- Spina AMP incl.
- Spessore del materiale della superficie di incasso: 25 mm max.



Down 60lm | 3000K

Versione	Articolo	EUR
○ bianco	113292	54,00
● grigio	111292	54,00



Articolo	Articolo	EUR
Scatola da incasso		
● nero	112781	10,90
Prolunga cavi 1m		
○ bianco	111861	7,75
Driver Led 3W 350mA presa AMP inclusa		
○ bianco	1007270	19,80
Presa multipla a 3 uscite		
● nero	111850	13,40
Telaio sotto intonaco		
● oro	112780	6,35

1000577 238

QUAD FRAME 9 WL

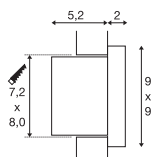

L70B50

100-240V ~50/60Hz | 350mA

Potenza assorbita: 3W

Materiale: alluminio

- Spessore del materiale della superficie di incasso: 30 mm max



Down

75lm | 3000K

Versione	Articolo	EUR
○ bianco	1003466	92,00



Articolo	Articolo	EUR
Scatola da incasso		
● nero	112781	10,90
Telaio sotto intonaco		
● oro	112780	6,35

1003466 240



NOTAPO S
RLNOTAPO L
RL

1002979 241

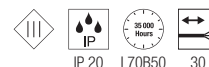
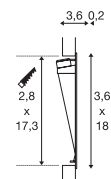
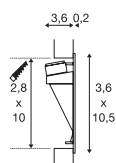

700mA
Potenza assorbita: 2,2W
Materiale: alluminio

- In caso di utilizzo di più apparecchi, collegare in serie.
- Molle a balestra
- Cavo con terminale aperto

700mA
Potenza assorbita: 2,2W
Materiale: alluminio

- In caso di utilizzo di più apparecchi, collegare in serie.
- Molle a balestra
- Cavo con terminale aperto



Down 6lm | 3000K

Down 6lm | 3000K

1002980 241

Versione	Articolo	EUR
○ bianco	1002979	60,00

Versione	Articolo	EUR
○ bianco	1002980	82,00



Articolo	Articolo	EUR
Driver LED 25W 150-700mA dimmerabile DALI		
○ bianco	1007229	70,00
Driver LED 3W 700mA		
○ bianco	1007216	23,00
NOTAPO Telaio da incasso		
● nero	1002981	24,25

Articolo	Articolo	EUR
Driver LED 10W 700mA dimmerabile con serracavo		
○ bianco	1007213	35,00
Driver LED 3W 700mA con serracavo		
○ bianco	1007216	23,00
NOTAPO Telaio da incasso		
● nero	1002981	24,25

DOWNUNDER PUR 80 EL

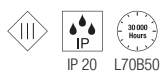
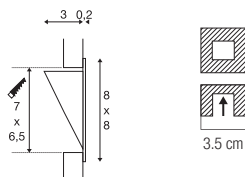

350mA
Potenza assorbita: 6W
Materiale: alluminio/acciaio

- In caso di utilizzo di più apparecchi, collegare in serie.
- Molle a balestra



Down 180lm | 3000K

Versione	Articolo	EUR
<input type="radio"/> bianco	151950	60,00



Articolo	Articolo	EUR
Telaio da incasso		
<input checked="" type="radio"/> grigio	151960	9,05
Prolunga cavi 1m		
<input type="radio"/> bianco	111861	7,75
Driver Led 3W 350mA presa AMP inclusa		
<input type="radio"/> bianco	1007270 ●	19,80
Presa multipla a 3 uscite		
<input checked="" type="radio"/> nero	111850	13,40

DOWNUNDER PUR 150 EL

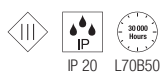
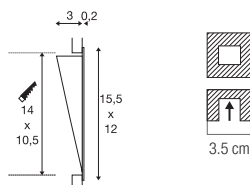

500mA
Potenza assorbita: 5,2W
Materiale: alluminio/acciaio

- In caso di utilizzo di più apparecchi, collegare in serie.
- Molle a balestra



Down 230lm | 3000K

Versione	Articolo	EUR
<input type="radio"/> bianco	151952	86,00



Articolo	Articolo	EUR
Telaio da incasso		
<input checked="" type="radio"/> grigio	151962	12,90
Driver LED 20W 350-500mA PHASE		
<input type="radio"/> bianco	1007227 ●	40,00
Driver LED 25W 150-700mA dimmerabile DALI		
<input type="radio"/> bianco	1007229 ●	70,00
Driver LED 21W 500mA		
<input type="radio"/> bianco	1007226 ●	30,00

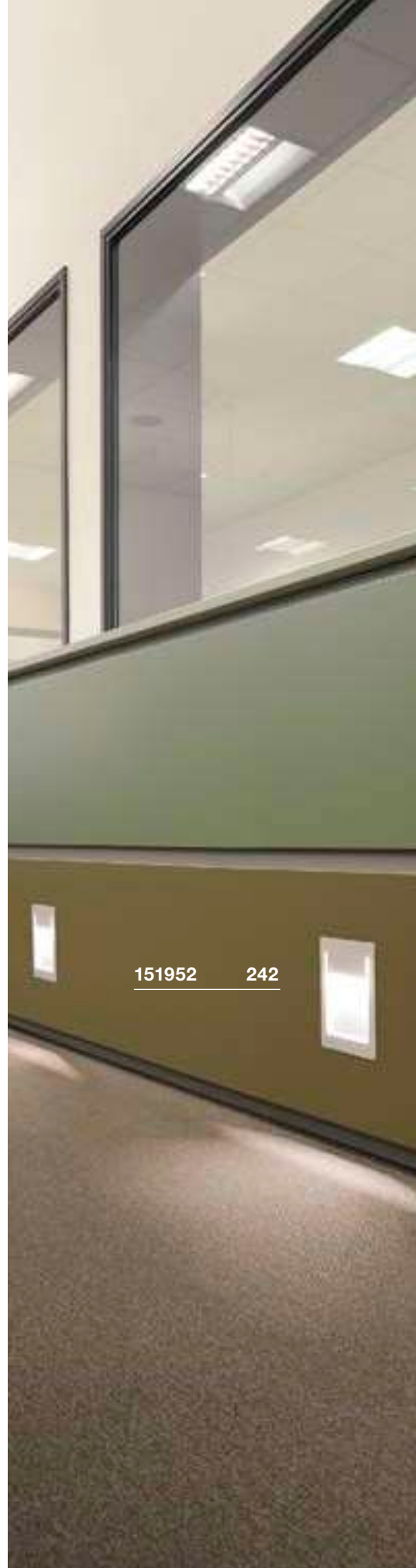

151952

242

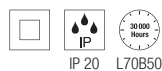
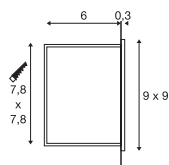
MOBALA
EL

100-240V ~50/60Hz
Potenza assorbita: 1,3W
Materiale: alluminio

- Per l'installazione sono necessari il telaio da incasso (1002984) o la scatola da incasso (1002983).
- Molle a balestra



Down 14lm | 3000K

Versione	Articolo	EUR
○ bianco	1002982	72,00

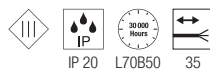
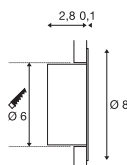

Articolo	Articolo	EUR
Driver LED 3W 350mA		
○ bianco	1005248	15,00

WORO
EL

350mA
Potenza assorbita: 1,2W
Materiale: acciaio

- In caso di utilizzo di più apparecchi, collegare in serie.
- L'articolo è adatto all'installazione in scatole da incasso tonde da 60mm
- Clip di fissaggio
- Cavo con terminale aperto



Down 50lm | 3000K

Versione	Articolo	EUR
○ bianco	1002922	70,00

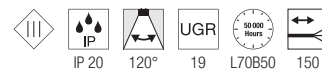
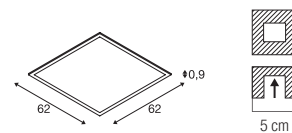

Articolo	Articolo	EUR
Driver LED 20W 350mA/500mA PHASE		
○ bianco	1007227	40,00

LED PANEL
620x620mm

1050mA
Potenza assorbita: 35W
Materiale: alluminio/polistirolo (PS)

- Cavo con terminale aperto



Down 4000lm | 3000K
4000K

Versione	Articolo	EUR
○ bianco		
3000K	1003073	202,00
○ bianco		
4000K	1003074	202,00



Articolo	Articolo	EUR
Set per sospensione 1,5 m		
● cromo	158799	20,00
Driver LED, 40W 1050mA DALI dimmerabile con interfaccia RF		
○ bianco	1006197	100,00
Driver LED 40W 10500mA dimmerabile		
○ bianco	464804	57,00
Modulo RF per driver DALI		
○ bianco	1006454	129,00
Modulo RF per driver DALI		
○ bianco	1006199	38,00

PATTA-I
EL, rotondo, PHASE

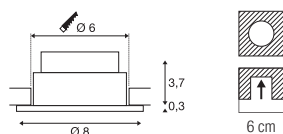

220-240V ~50/60Hz | 350mA
Potenza assorbita: 7,3W
Materiale: alluminio/vetro

- Clip di fissaggio
- Spessore del materiale della superficie di incasso: 20 mm max



Down 440lm | 1800-3000K

Versione	Articolo	EUR
● nero	1002098	86,00
○ bianco	1002099	86,00
● alluminio	1002100	90,00

PATTA-I
DL, quadrato, PHASE

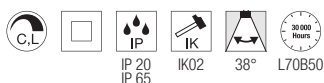
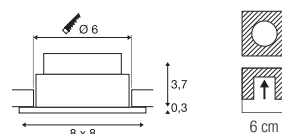

220-240V ~50/60Hz | 350mA
Potenza assorbita: 7,3W
Materiale: alluminio/vetro

- Clip di fissaggio
- Spessore del materiale della superficie di incasso: 20 mm max



Down 440lm | 1800-3000K

Versione	Articolo	EUR
● nero	1002101	86,00
○ bianco	1002102	86,00

1002099 244



1002101 244



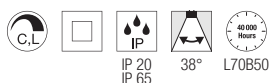
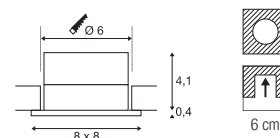
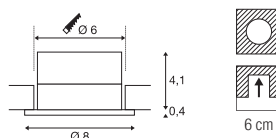

1002098 244

PATTA-I
EL, rotondo, PHASEPATTA-I
EL, quadrato, PHASE220-240V ~50/60Hz | 500mA
Potenza assorbita: 11W
Materiale: alluminio/vetro

- Clip di fissaggio
- Spessore del materiale della superficie di incasso: 25 mm max.

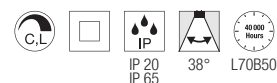
220-240V ~50/60Hz | 500mA
Potenza assorbita: 11W
Materiale: alluminio/vetro

- Clip di fissaggio
- Spessore del materiale della superficie di incasso: 25 mm max.

114431 245



Down 910lm | 3000K

Versione	Articolo	EUR
● nero	114420	86,00
○ bianco	114421	86,00
● alluminio	114426	90,00



Down 910lm | 3000K

Versione	Articolo	EUR
● nero	114430	86,00
○ bianco	114431	86,00
● alluminio	114436	90,00

114451 247

PATTA-F
EL, rotondo, PHASE

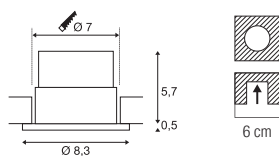

220-240V ~50/60Hz | 500mA

Potenza assorbita: 11W

Materiale: alluminio/vetro

- Clip di fissaggio
- Spessore del materiale della superficie di incasso: 20 mm max



Down 745lm | 3000K
860lm

Versione	Articolo	EUR
● nero 745lm	114440	97,00
○ bianco 860lm	114441	97,00





114450 247

PATTA-F EL, quadrato, PHASE

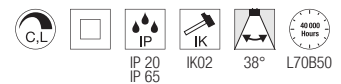
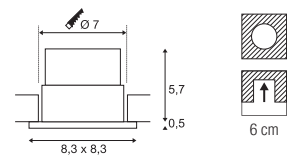

220-240V ~50/60Hz | 500mA

Potenza assorbita: 11W

Materiale: alluminio/vetro

- Clip di fissaggio
- Spessore del materiale della superficie di incasso: 20 mm max



CRI 80

Down

745lm | 3000K
860lm

Versione	Articolo	EUR
● nero		
745lm	114450	97,00
○ bianco		
860lm	114451	97,00





NUMINOS®
alle pagine
102-105

LED



MEDO®
alle pagine
164-165

LED



SCKET
VARYT | 251



LED
Q-LINE® | 253



LED
Q-LINE® | 253



SCKET
TRILEDO | 255



SCKET
TRILEDO | 255



SCKET
TRILEDO | 255



LED
TRILEDO | 257



LED
TRILEDO | 257



LED
TRILEDO | 257



LED
OCULUS | 258



SCKET
ENOLA B | 259



LED
ENOLA C | 259



SCKET
ASTINA | 261



SCKET
NAGY 75 | 261



LED
ANELA | 261



LED
OCCULDAS 13 | 262



LED
OCCULDAS 23 | 262



SCKET
ALTRA DICE | 263



SCKET
ALTRA DICE | 263



SCKET
KARDAMOD | 265



SCKET
KARDAMOD | 265



SCKET
FENDA | 266



FENDA | 267



FENDA | 267



FENDA | 267



SCKET
TENORA | 268



SCKET
SOPRANA | 269



SCKET
PLASTRA | 270



LED
PLASTRA | 271



SCKET
PLASTRA 105 | 271



SCKET
PLASTRA 104 | 271



LED
FERA 25 | 272



LED
FERA 25 | 272



LED
MARONA | 273



LED
PANEL 60 | 274



LED
PANEL | 275



LED
PANEL 60 | 275



LED
PANEL | 275

1007605 251

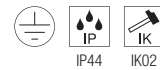
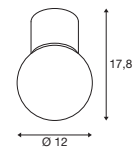

VARYT
CL, E14220-240V ~50/60Hz
Materiale: alluminio**SOCKET
INSIDE** <6
W

Attacco: 1xE14 | Ø max.: 3,8 cm | L: 11 cm

Versione	Articolo	EUR
● nero	1007607	159,00
○ bianco	1007606	159,00
● cromo	1007604	180,00
● ottone	1007605	189,00

C35 | 4,2W | 320°
2700K | 350lm | Classe=G
5kWh/1000h

Articolo: 1005285 | 8,50 EUR

1000692 253

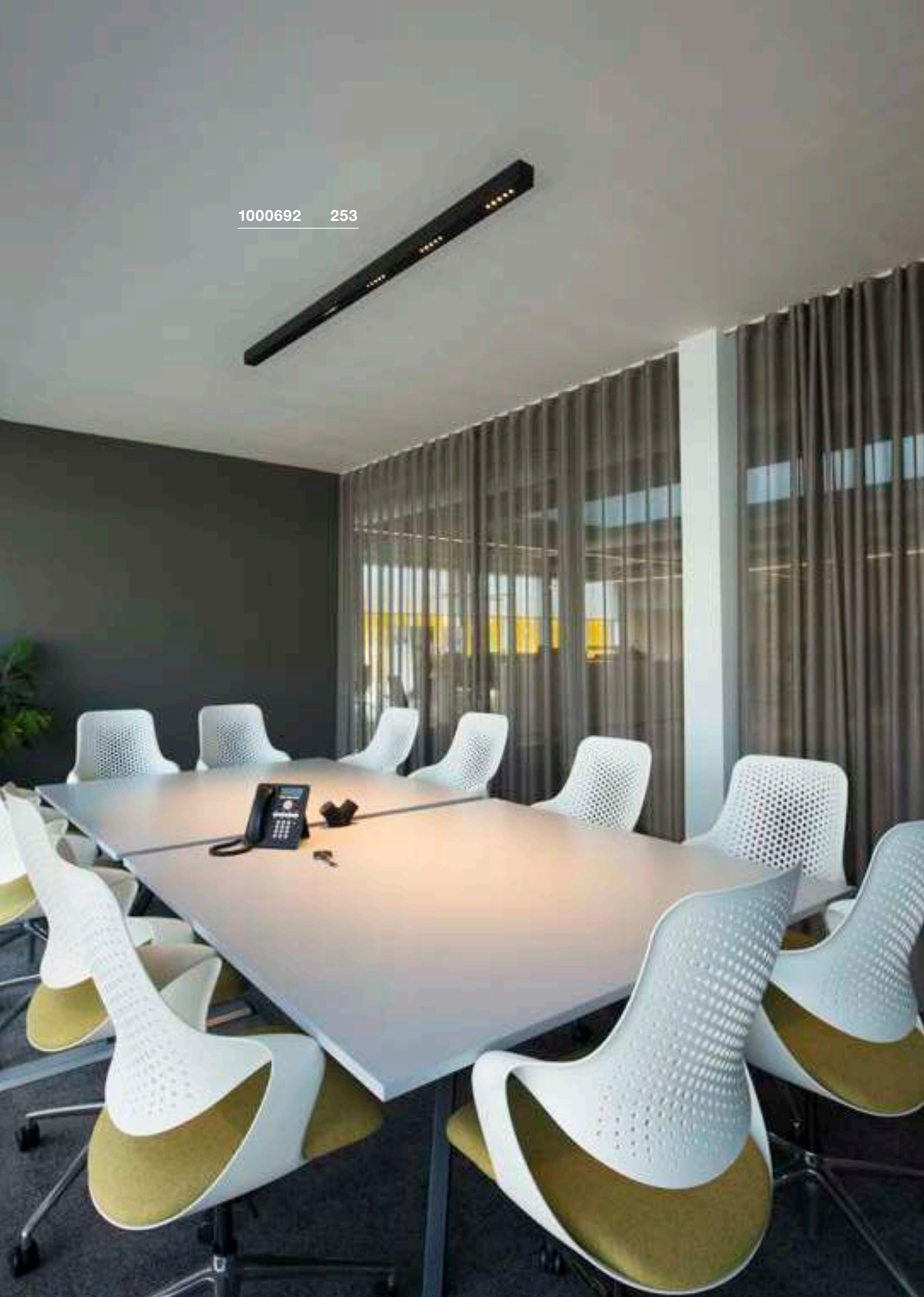



Q-LINE® CL, 1m, BAP, PHASE

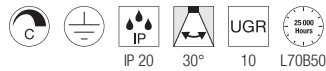
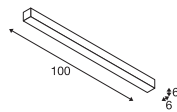

220-240V ~50/60Hz | 900mA
Potenza assorbita: 46W
Materiale: alluminio/plastica



Down 2100lm | 3000K
2300lm | 4000K

Versione	Articolo	EUR
● nero 2100lm 3000K	1000686	464,00
○ bianco 2100lm 3000K	1000685	464,00
● nero 2300lm 4000K	1000689	464,00
○ bianco 2300lm 4000K	1000688	464,00

Q-LINE® CL, 2m, BAP, PHASE

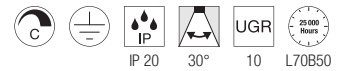
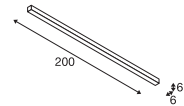

220-240V ~50/60Hz | 900mA
Potenza assorbita: 93W
Materiale: alluminio/plastica



Down 4200lm | 3000K
4600lm | 4000K

Versione	Articolo	EUR
● nero 4200lm 3000K	1000692	696,00
○ bianco 4200lm 3000K	1000691	696,00
● nero 4600lm 4000K	1000695	696,00
○ bianco 4600lm 4000K	1000694	696,00

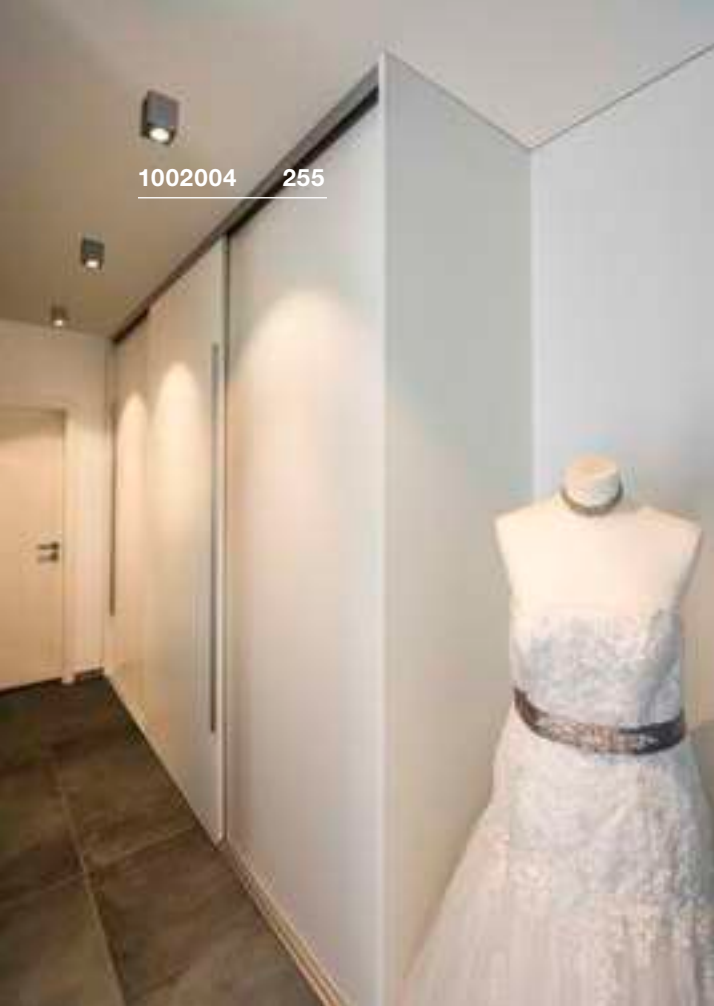

1002004 255



1002011 255



1002005 255



TRILEDO
CL, single, quadrato, QPAR51

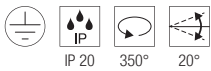
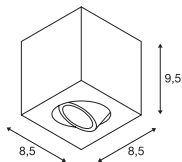

220-240V ~50/60Hz
Materiale: alluminio



Attacco: 1xGU10 max. Ø: 5,1 cm | L: 5,5 cm

Versione	Articolo	EUR
● nero	1002013	73,00
○ bianco	1002015	73,00
● alluminio	1002004	78,00



LED GU10 51mm | 6W | 38°
2700K | 450lm | Classe=F
6kWh/1000h



Articolo: 1005075 | 7,50 EUR

TRILEDO
CL, double, quadrato, QPAR51

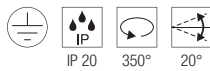
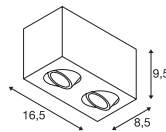

220-240V ~50/60Hz
Materiale: alluminio



Attacco: 2xGU10 max. Ø: 5,1 cm | L: 5,5 cm

Versione	Articolo	EUR
● nero	1002005	107,00
○ bianco	1002006	107,00



LED GU10 51mm | 6W | 38°
2700K | 450lm | Classe=F
6kWh/1000h



Articolo: 1005077 | 7,50 EUR

TRILEDO
CL, single, rotondo, QPAR51

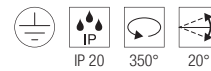
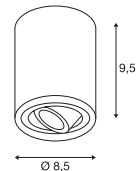

220-240V ~50/60Hz
Materiale: alluminio



Attacco: 1xGU10 max. Ø: 5,1 cm | L: 5,5 cm

Versione	Articolo	EUR
● nero	1002010	73,00
○ bianco	1002011	73,00
● alluminio	1002012	78,00



LED GU10 51mm | 6W | 38°
2700K | 450lm | Classe=F
6kWh/1000h



Articolo: 1005075 | 7,50 EUR

113940 257



113931 257

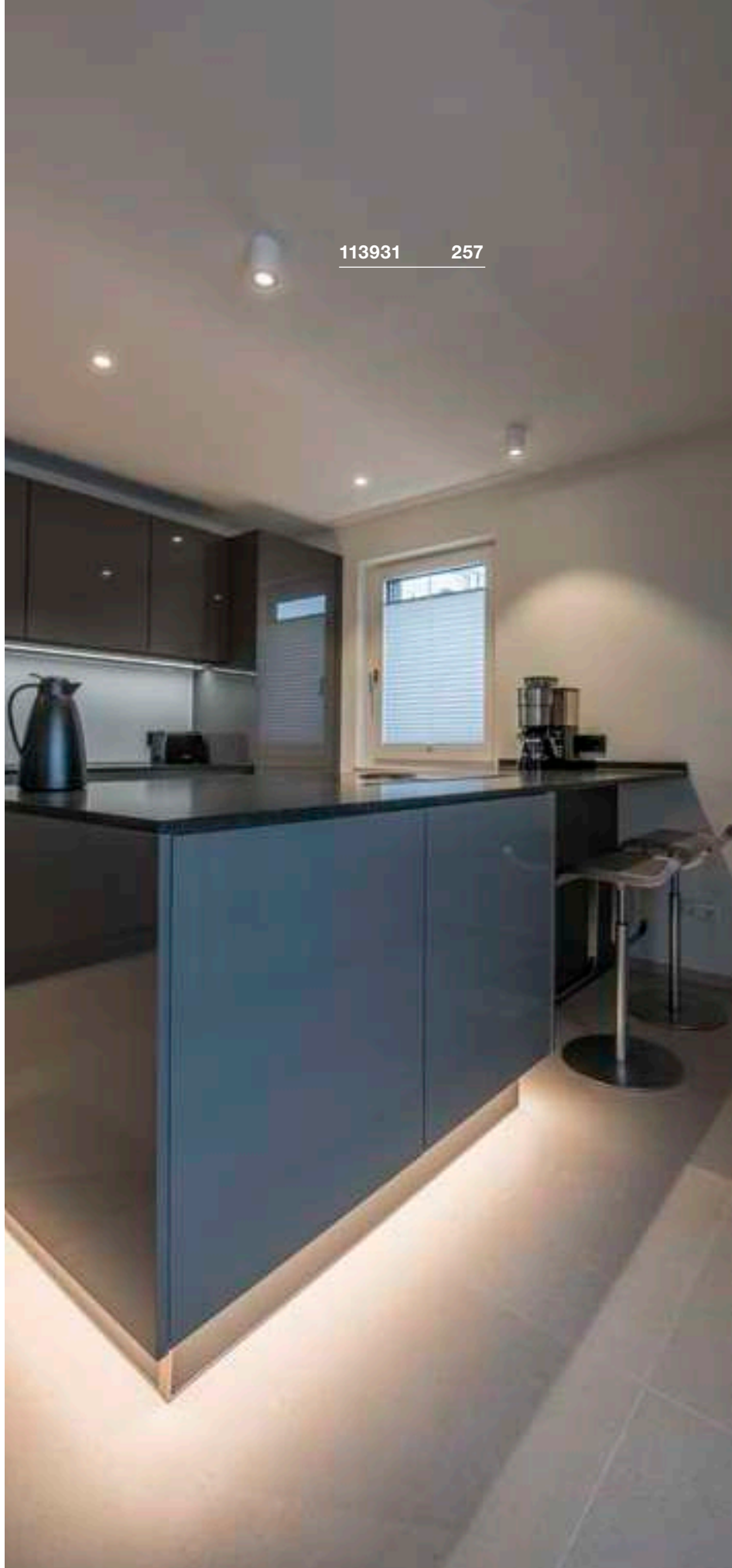

1002003 257





TRILEDO
CL, single, quadrato

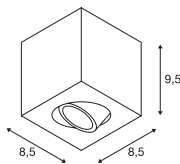

220-240V ~50/60Hz | 350mA
Potenza assorbita: 7,6W
Materiale: alluminio/alluminio



Down 640lm | 3000K

Versione	Articolo	EUR
● nero	113940	117,00
○ bianco	113941	117,00

TRILEDO
CL, double, quadrato

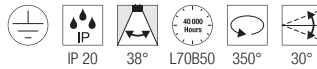
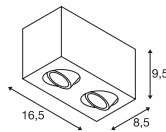

220-240V ~50/60Hz | 350mA
Potenza assorbita: 14W
Materiale: alluminio



Down 1300lm | 3000K

Versione	Articolo	EUR
● nero	1002003	163,00
○ bianco	1002008	163,00

TRILEDO
CL, single, rotondo

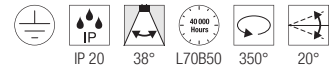
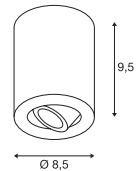

220-240V ~50/60Hz | 350mA
Potenza assorbita: 7,6W
Materiale: alluminio/alluminio



Down 640lm | 3000K

Versione	Articolo	EUR
● nero	113930	117,00
○ bianco	113931	117,00

OCULUS CL, PHASE

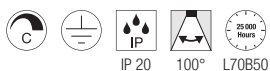
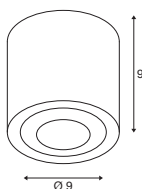

220-240V ~50/60Hz | 250mA

Potenza assorbita: 11W

Materiale: alluminio/vetro

- Inclusa lente smerigliata aggiuntiva



Down 36lm | 2000K - 780lm | 3000K

Versione	Articolo	EUR
● nero	1004666	229,00
○ bianco	1004667	229,00

1004667 258



151811 259

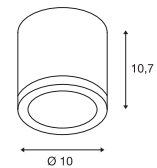
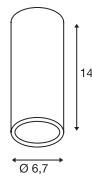

**ENOLA B**
CL, QPAR51**ENOLA C**
CL

IP 20

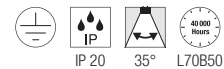
220-240V ~50/60Hz
Materiale: alluminio

IP 20 35° L70B50

220-240V ~50/60Hz | 500mA
Potenza assorbita: 11W
Materiale: alluminio

Attacco: 1xGU10

max. L: 8,5 cm

Versione	Articolo	EUR
● nero	151810	53,00
○ bianco	151811	53,00

LED GU10 51mm | 6W | 36°
2200-2700K | 360lm | Classe=G
6kWh/1000h**Articolo: 1005273 | 9,99 EUR**

Articolo	Articolo	EUR
Anello decorativo		
● nero	151840	8,95



Down

1020lm | 3000K

Versione	Articolo	EUR
○ bianco	152101	198,00

1002936 261



1002965 261



1000808 261





ASTINA
CL, QPAR51

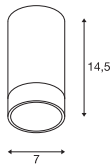

220-240V ~50/60Hz
Materiale: alluminio



Attacco: 1xGU10

Versione	Articolo	EUR
● nero	1002936	88,00
○ bianco	1002934	88,00



LED GU10 51mm | 6W | 38°
2700K | 450lm | Classe=F
6kWh/1000h



Articolo: 1005075 | 7,50 EUR

NAGY 75
CL, QPAR51

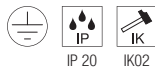
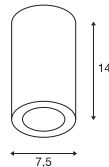

220-240V ~50/60Hz
Materiale: gesso



Attacco: 1xGU10

Versione	Articolo	EUR
○ bianco	1002965	57,00



LED GU10 51mm | 6W | 36°
2200-2700K | 360lm | Classe=G
6kWh/1000h



Articolo: 1005273 | 9,99 EUR

ANELA
CL, PHASE

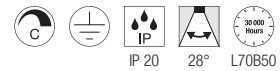
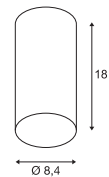

220-240V ~50/60Hz | 500mA
Potenza assorbita: 10W
Materiale: alluminio



Down 220lm | 3000K | 750lm | 3000K

Versione	Articolo	EUR
● nero	1000807	156,00
○ bianco	1000808	156,00



Articolo	Articolo	EUR
Riflettore 28°		
● nero	1000811	19,75
○ bianco	1000812	19,75
● oro	1000809	19,75
● argento	1000810	19,75

OCCULDAS 13
CL, indiretta, PHASE

OCCULDAS 23
CL, indiretta, PHASE

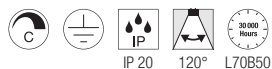
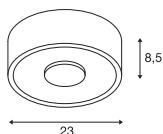
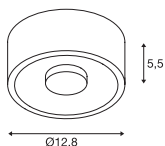

220-240V ~50/60Hz | 350mA
Potenza assorbita: 15W
Materiale: alluminio

220-240V ~50/60Hz | 700mA
Potenza assorbita: 24W
Materiale: alluminio



Down 810lm | 3000K



Down 1500lm | 3000K

Versione	Articolo	EUR
<input type="radio"/> bianco	117351	202,00

Versione	Articolo	EUR
<input type="radio"/> bianco	117321	333,00





ALTRA DICE
CL, QPAR51

ALTRA DICE
CW, double, QPAR51

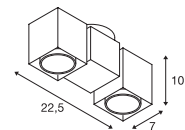
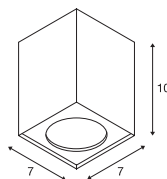

1002215 263



220-240V ~50/60Hz
Materiale: alluminio/acciaio



Attacco: 1xGU10

Versione	Articolo	EUR
● nero	1002216	60,00
○ bianco	151511	60,00
●● grigio/nero	151514	60,00



LED GU10 51mm | 6W | 38°
2700K | 450lm | Classe=F
6kWh/1000h



Articolo: 1005077 | 7,50 EUR

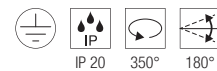

220-240V ~50/60Hz
Materiale: alluminio/acciaio



Attacco: 2xGU10

Versione	Articolo	EUR
● nero	1002215	109,00
○ bianco	151531	109,00
●● grigio	151534	109,00



LED GU10 51mm | 6W | 36°
2200-2700K | 360lm | Classe=G
6kWh/1000h



Articolo: 1005273 | 9,99 EUR

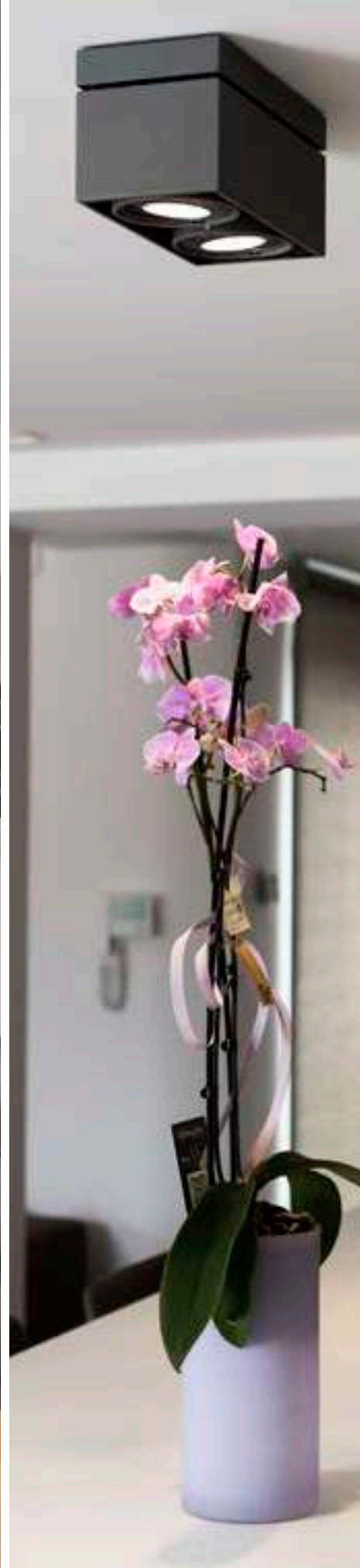



KARDAMOD

CL, single, quadrato, QPAR111

KARDAMOD

CL, double, quadrato, QPAR111

117110 265

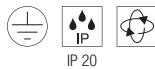
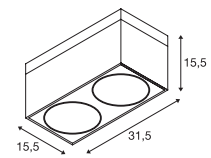
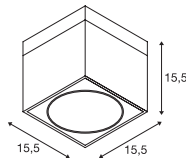

IP 20

220-240V ~50/60Hz
Materiale: acciaio



Attacco: 1xGU10

Versione	Articolo	EUR
● nero	117100	141,00
○ bianco	117101	141,00



QPAR111 | 12,5W | 30°
2700K | 950lm | Classe=F
13kWh/1000h



Articolo: 1005276 | 49,50 EUR



IP 20

220-240V ~50/60Hz
Materiale: acciaio



Attacco: 2xGU10

Versione	Articolo	EUR
● nero	117110	252,00
○ bianco	117111	252,00



QPAR111 | 8W | 38°
2700K | 680lm | Classe=F
8kWh/1000h



Articolo: 1005274 | 30,75 EUR

FENDA
Rosone a plafone, E27

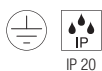
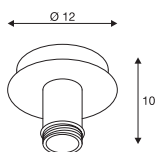

220-240V ~50/60Hz
Materiale: acciaio



Attacco: 1xE27

Versione	Articolo	EUR
● nero	155550	46,75
○ bianco	155551	46,75



LED E27 | 7,5W | 320°
2700K | 800lm | Classe=F
8kWh/1000h



Articolo: 1005268 | 12,25 EUR

155551 + 1004775 266 + 267

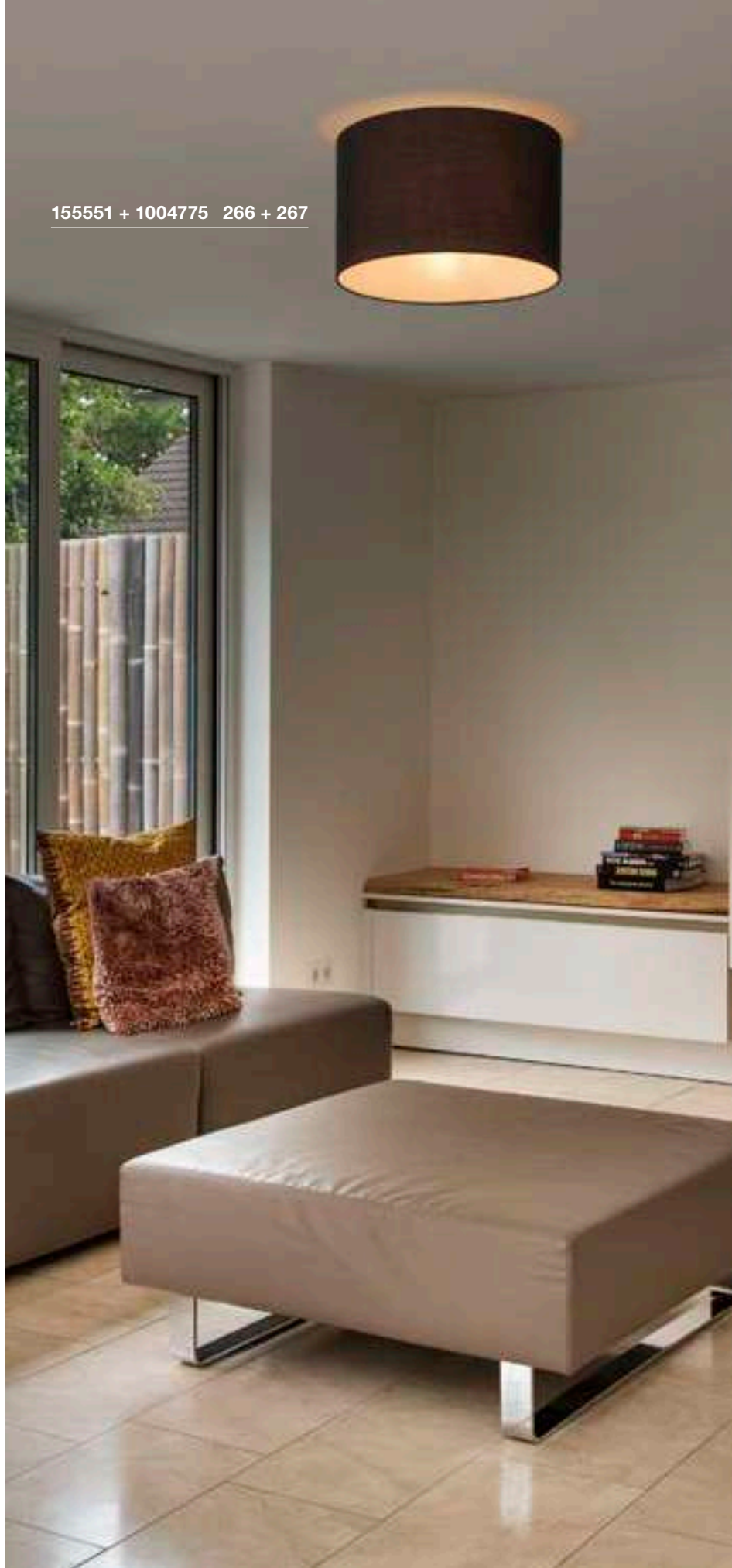



FENDA

30 cm, rotondo



H: 20 cm
 Ø: 30 cm
 Materiale: tessuto/acciaio

FENDA

Ø 45 cm, rotondo



H: 28 cm
 Ø: 45,5 cm
 Materiale: tessuto/acciaio

FENDA

Ø 70 cm, rotondo



H: 36 cm
 Ø: 70 cm
 Materiale: tessuto/acciaio

• Non adatto a Fenda Bow.

Versione	Articolo	EUR
●● nero/rame	155592	70,00
○ bianco	155582	53,00
● grigio	1004774	53,00
● beige	155583	53,00

Versione	Articolo	EUR
●● nero/rame	156122	88,00
○ bianco	156111	83,00
● grigio	1004775	83,00
● beige	156113	83,00

Versione	Articolo	EUR
●● nero/rame	1000580	129,00
○ bianco	1000579	112,00



156050 268

TENORA
CL, E27

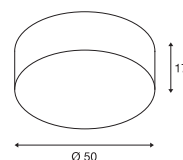

220-240V ~50/60Hz
Materiale: acciaio/tessuto



Attacco: 3xE27

max. L: 14,8 cm

Versione	Articolo	EUR
● nero	156050	187,00
○ bianco	156051	187,00



LED E27 | 13,2W | 220°
2700K | 1300lm | Classe=F
13kWh/1000h



Articolo: 1005302 | 12,25 EUR

**SOPRANA**
CL, E27

155373 269

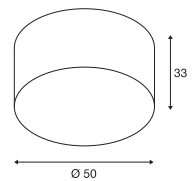
220-240V ~50/60Hz
Materiale: acciaio/tessuto

Attacco: 3xE27

Versione	Articolo	EUR
● beige	155373	206,00

A60 | 7,5W | 320°
2700K | 800lm | Classe=F
8kWh/1000h

Articolo: 1005303 | 9,60 EUR

148004 270



PLASTRA CL, QPAR51

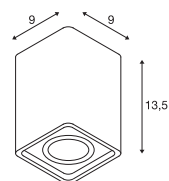

148005 271



220-240V ~50/60Hz
Materiale: gesso/acciaio

SOCKET **INSIDE** <35
W

Attacco: 1xGU10

Versione	Articolo	EUR
○ bianco	148004	67,00



LED GU10 51mm | 6W | 38°
2700K | 450lm | Classe=F
6kWh/1000h



Articolo: 1005077 | 7,50 EUR



PLASTRA
CL, PHASE

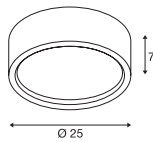

220-240V ~50/60Hz | 350mA
Potenza assorbita: 15W
Materiale: gesso/vetro



Down 990lm | 3000K

Versione	Articolo	EUR
○ bianco	148005	133,00

PLASTRA 105
CL, E27

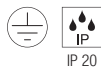
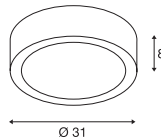

220-240V ~50/60Hz
Materiale: gesso/vetro



Attacco: 2xE27 max. Ø: 5,1 cm | L: 14 cm

Versione	Articolo	EUR
○○ bianco/trasparente	148001	91,00



LED E27 | 8W | 240°
4000K | 920lm | Classe=E
8kWh/1000h



Articolo: 1005290 | 10,25 EUR

PLASTRA 104
CL, E27

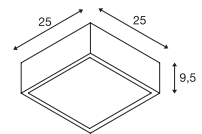

220-240V ~50/60Hz
Materiale: gesso/vetro



Attacco: 2xE27 max. Ø: 5,1 cm | L: 14 cm

Versione	Articolo	EUR
○○ bianco/trasparente	148002	85,00



LED E27 | 8W | 240°
4000K | 920lm | Classe=E
8kWh/1000h



Articolo: 1005290 | 10,25 EUR

FERA 25
CL, DALI

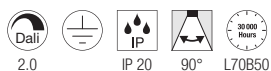
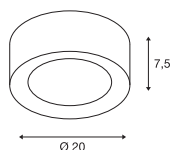

220-240V ~50/60Hz | 500mA
Potenza assorbita: 20W
Materiale: policarbonato (PC)/
polimetilmetacrilato (PMMA)



Down 1580lm | 3000K | 1650lm | 4000K

Versione	Articolo	EUR
● nero	1002968	272,00
○ bianco	1002967	272,00

FERA 25
CL

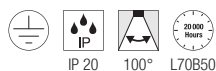
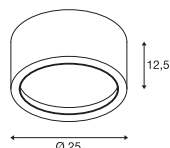

220-240V ~50/60Hz | 550mA
Potenza assorbita: 23W
Materiale: alluminio/polistirene (PS)



Down 1800lm | 3000K

Versione	Articolo	EUR
● nero	1001939	201,00
○ bianco	161461	201,00



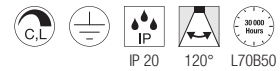
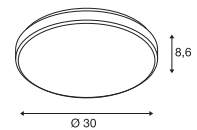

1001939 272

MARONA
CL, PHASE

200-240V ~50/60Hz | 430mA
Potenza assorbita: 15W
Materiale: polimetilmetacrilato (PMMA)/
acciaio



Down 1200lm | 3000K

Versione	Articolo	EUR
● grigio	155156	115,00



155156 273



1000785 274

PANEL 60
CL, rotondo, PHASE

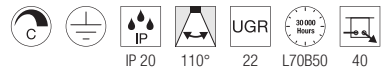
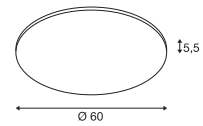

220-240V ~50/60Hz | 1000mA
Potenza assorbita: 42W
Materiale: alluminio/
polimetilmetacrilato (PMMA)



Down 3150lm | 3000K
3350lm | 4000K

Versione	Articolo	EUR
○ bianco 3150lm 3000K	1000783	292,00
○ bianco 3350lm 4000K	1000784	292,00
● grigio 3150lm 3000K	1000785	292,00
● grigio 3350lm 4000K	1000786	292,00



PANEL
CL, 1200x300mm, PHASE

PANEL 60
CL, rotondo, DALI

PANEL
CL, 1200x300mm, DALI

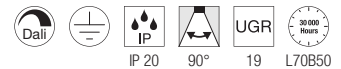
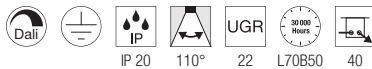
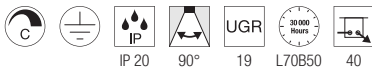
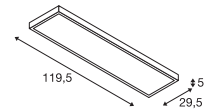
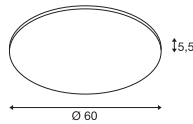
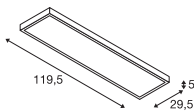

220-240V ~50/60Hz | 1000mA
Potenza assorbita: 45W
Materiale: alluminio/
polimetilmetacrilato (PMMA)

100-277V ~50/60Hz | 200mA
Potenza assorbita: 43W
Materiale: alluminio/
polimetilmetacrilato (PMMA)

100-277V ~50/60Hz | 200mA
Potenza assorbita: 43W
Materiale: alluminio/
polimetilmetacrilato (PMMA)



Down 3100lm | 3000K
3400lm | 4000K

Down 3150lm | 3000K
3350lm | 4000K

Down 3100lm | 3000K
3400lm | 4000K

Versione	Articolo	EUR
○ bianco		
3100lm 3000K CRI80	1001505	278,00
○ bianco		
3400lm 4000K CRI80	1001506	278,00
● grigio		
3100lm 3000K CRI80	1001508	278,00
● grigio		
3400lm 4000K CRI90	1001509	278,00

Versione	Articolo	EUR
○ bianco		
3150lm 3000K	1003040	302,00
○ bianco		
3350lm 4000K	1003041	302,00
● grigio		
3150lm 3000K	1003042	302,00
● grigio		
3350lm 4000K	1003043	302,00

Versione	Articolo	EUR
○ bianco		
3100lm 3000K	1003052	289,00
○ bianco		
3400lm 4000K	1003053	289,00
● grigio		
3100lm 3000K	1003054	289,00
● grigio		
3400lm 4000K	1003055	289,00



SCKET
PANTILO
ROPE 19 | 279



SCKET
PANTILO
ROPE 20 | 279



SCKET
PANTILO
ROPE 27 | 279



SCKET
PANTILO OVAL | 281



SCKET
PANTILO 20 | 281



SCKET
PANTILO 28 | 281



SCKET
PANTILO
CONVEX 29 | 283



SCKET
PANTILO
CONVEX 40 | 283



SCKET
ASTO TUBE | 285



SCKET
ASTO TUBE | 285



SCKET
ASTO TUBE | 285



SCKET
ASTO TUBE | 285



LED
WORKLIGHT
PRO 120 | 287



LED
WORKLIGHT
PRO 150 | 287



LED
WORKLIGHT | 288



LED
I-PENDANT PRO | 289



LED
PANEL 60 | 289



LED
NOYA | 290



LED
GLENOS® | 291



LED
GLENOS® | 291



LED
Q-LINE® | 293



LED
Q-LINE® | 293



LED
Q-LINE® | 293



LED
OCULUS | 294



SCKET
FITU | 295



SCKET
FENDA | 296



FENDA | 296



FENDA | 296



FENDA | 297



FENDA | 297



FENDA | 297



LED
HELIA
AMBIENT 35 | 300



LED
HELIA
AMBIENT 35 | 300



LED
HELIA 30 | 301



LED
HELIA 30 | 301



LED
HELIA 40 | 303



LED
HELIA 40 | 303



SCKET
ASTINA | 305



SCKET
ENOLA B | 305



SCKET
ENOLA | 305



LED
ANELA | 306



SCKET
LISENNE | 306



SCKET
TONGA® | 307



SCKET
QUADRASS | 307



SCKET
PARA CONE GL | 309



SCKET
PARA CONE 20 | 309



SCKET
PARA CONE 30 | 309



SCKET
PHELIA 10 | 310



SCKET
PHELIA 20 | 311



SCKET
PHELIA 25 | 311



SCKET
PHELIA 30 | 311



SCKET
FORCHINI 50 | 312



SCKET
FORCHINI 70 | 312



SCKET
FORCHINI M 40 | 313



SCKET
FORCHINI M 50 | 313



SCKET
LIGHT EYE® 90 | 314



SCKET
LIGHT EYE® 150 | 314



SCKET
SUN / BIG SUN | 315



SCKET
ROTOBALL 25 | 317



SCKET
ROTOBALL 40 | 317



SCKET
ROTOBALL 50 | 317



SCKET
PARA DOME | 318



PARA DOME | 318



PARA DOME | 318



SCKET
PARA 380 | 319



1007588 279

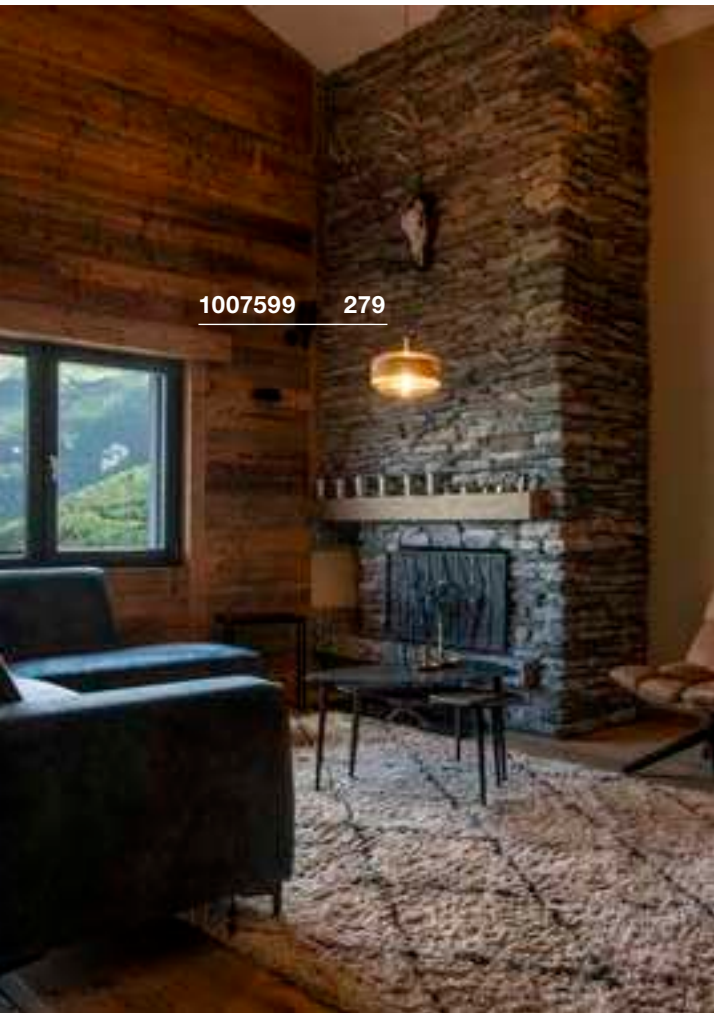

1007599 279



1007597 279



PANTILO ROPE 19 PD, E27

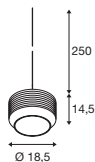

200-240V ~50/60Hz
Materiale: acciaio/vetro/canapa

- Cavo con terminale aperto

SOCKET INSIDE <15 W

Attacco: 1xE27 Ø max.: 10 cm L: 11 cm

Versione	Articolo	EUR
● ambra/oro	1007597	199,00
● antracite/argento	1007596	199,00

A60 | 7,5W | 180°
 2700K | 720lm | Classe=F
 8kWh/1000h

Articolo: 1005305 | 19,00 EUR



Articolo	Articolo	EUR
Adattatore monofase		
● nero	143120	15,00
○ bianco	143121	15,00
● grigio	143124	15,00
Adattatore trifase		
● nero	145990	19,70
● grigio	145994	19,70
○ bianco	1001542	19,70
Rosone FITU singolo		
● nero	132600	26,00
○ bianco	132601	26,00
● oro	1002163	28,50
● cromo	132605	28,50

PANTILO ROPE 20 PD, E27

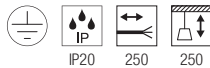
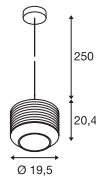

200-240V ~50/60Hz
Materiale: acciaio/vetro/canapa

SOCKET INSIDE <15 W

Attacco: 1xE27 Ø max.: 10 cm L: 18 cm

Versione	Articolo	EUR
● ambra/oro	1007589	239,00
● antracite/argento	1007588	239,00

A60 | 7,5W | 180°
 2700K | 720lm | Classe=F
 8kWh/1000h

Articolo: 1005305 | 19,00 EUR

PANTILO ROPE 27 PD, E27

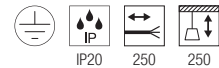
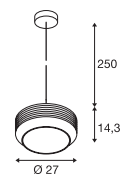

200-240V ~50/60Hz
Materiale: acciaio/vetro/canapa

SOCKET INSIDE <15 W

Attacco: 1xE27 Ø max.: 15 cm L: 11 cm

Versione	Articolo	EUR
● ambra/oro	1007599	259,00
● antracite/argento	1007598	259,00

A60 | 7,5W | 180°
 2700K | 720lm | Classe=F
 8kWh/1000h

Articolo: 1005305 | 19,00 EUR

1006403 281

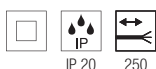
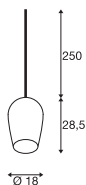

PANTILO OVAL
PD, E27200-240V ~50/60Hz
Materiale: vetro

- Cavo con terminale aperto

SOCKET INSIDE <15 W

Attacco: 1xE27

Versione	Articolo	EUR
○ bianco	1006402	155,00
● oro	1006403	175,00
● cromo	1006398	175,00
● rame	1006400	175,00

A60 | 7,5W | 180°
2700K | 720lm | Classe=F
8kWh/1000h

Articolo: 1005305 | 19,00 EUR

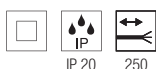
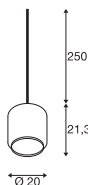

Articolo	Articolo	EUR
Adattatore monofase		
● nero	143120	15,00
○ bianco	143121	15,00
● grigio	143124	15,00
Adattatore trifase		
● nero	145990	19,70
● grigio	145994	19,70
○ bianco	1001542	19,70
Rosone		
● nero	1004744	34,00
○ bianco	1004745	34,00
● cromo	1004746	37,25
Rosone FITU singolo		
○ bianco	132601	26,00
● oro	1002163	28,50
Rosone FITU singolo		
● nero	132600	26,00
● cromo	132605	28,50

PANTILO 20
PD, E27200-240V ~50/60Hz
Materiale: vetro

- Cavo con terminale aperto

SOCKET INSIDE <15 W

Attacco: 1xE27

Versione	Articolo	EUR
○ bianco	1006396	155,00
● oro	1006395	175,00
● cromo	1003004	175,00
● rame	1003005	175,00

A60 | 7,5W | 180°
2700K | 720lm | Classe=F
8kWh/1000h

Articolo: 1005305 | 19,00 EUR

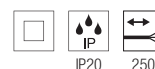
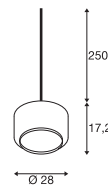

Articolo	Articolo	EUR
Adattatore monofase		
● nero	143120	15,00
○ bianco	143121	15,00
● grigio	143124	15,00
Adattatore trifase		
● nero	145990	19,70
● grigio	145994	19,70
○ bianco	1001542	19,70
Rosone FITU singolo		
○ bianco	132601	26,00
● oro	1002163	28,50
Rosone FITU singolo		
● nero	132600	26,00
● cromo	132605	28,50

PANTILO 28
PD, E27200-240V ~50/60Hz
Materiale: vetro

- Cavo con terminale aperto

SOCKET INSIDE <15 W

Attacco: 1xE27

Versione	Articolo	EUR
○ bianco	1006399	191,00
● oro	1006397	211,00
● cromo	1003006	211,00
● rame	1003007	211,00

A60 | 7,5W | 180°
2700K | 720lm | Classe=F
8kWh/1000h

Articolo: 1005305 | 19,00 EUR



Articolo	Articolo	EUR
Adattatore monofase		
● nero	143120	15,00
○ bianco	143121	15,00
● grigio	143124	15,00
Adattatore trifase		
● nero	145990	19,70
● grigio	145994	19,70
○ bianco	1001542	19,70
Rosone FITU singolo		
○ bianco	132601	26,00
● oro	1002163	28,50
Rosone FITU singolo		
● nero	132600	26,00
● cromo	132605	28,50



1003443 283

**PANTILO CONVEX 29**
PD, E27**PANTILO CONVEX 40**
PD, E27

1003444 283

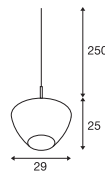
220-240V ~50/60Hz
Materiale: vetro/acciaio

- Cavo con terminale aperto

SOCKET
INSIDE 40 W

Attacco: E27 Ø max.: 10 cm L: 20 cm

Versione	Articolo	EUR
● cromo	1003443	247,00

A60 | 7,5W | 180°
2700K | 720lm | Classe=F
8kWh/1000h

Articolo: 1005305 | 19,00 EUR

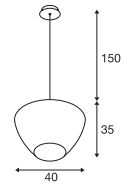

Articolo	Articolo	EUR
Adattatore monofase		
● nero	143120	15,00
○ bianco	143121	15,00
● grigio	143124	15,00
Adattatore trifase		
● nero	145990	19,70
● grigio	145994	19,70
○ bianco	1001542	19,70
Rosone FITU singolo		
○ bianco	132601	26,00
● oro	1002163	28,50
Rosone FITU singolo		
● nero	132600	26,00
● cromo	132605	28,50

220-240V ~50/60Hz
Materiale: vetro/acciaio**SOCKET**
INSIDE 40 W

Attacco: E27 Ø max.: 15 cm L: 30 cm

Versione	Articolo	EUR
● cromo	1003444	353,00

A60 | 7,5W | 180°
2700K | 720lm | Classe=F
8kWh/1000h

Articolo: 1005305 | 19,00 EUR

1006438 285





ASTO TUBE

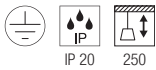

220-240V ~50/60Hz
Materiale: alluminio



Attacco: 1xGU10



LED GU10 51mm | 6W | 36°
2200-2700K | 360lm | Classe=G
6kWh/1000h



Articolo: 1005273 | 9,99 EUR

ASTO TUBE PD, single, GU 10

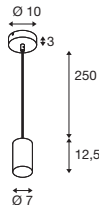

ASTO TUBE PD, double, GU 10

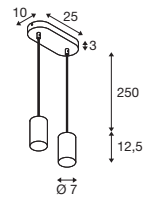

Versione	Articolo	EUR
● nero	1006431	60,00
○ bianco	1006432	60,00

Versione	Articolo	EUR
● nero	1006433	110,00
○ bianco	1006434	110,00

ASTO TUBE Riflettore decorativo



H: 3,95 cm
Ø: 6,75 cm
Materiale: policarbonato (PC)

ASTO TUBE PD, triple, GU 10

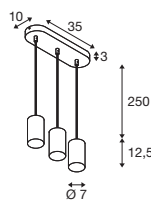

ASTO TUBE PD, quadruple, GU 10

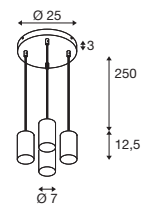

Versione	Articolo	EUR
● nero-cromo	1007190	4,00
● oro	1006450	4,00
● cromo	1006449	4,00
● rame	1006451	4,00

Versione	Articolo	EUR
● nero	1006435	160,00
○ bianco	1006436	160,00

Versione	Articolo	EUR
● nero	1006437	195,00
○ bianco	1006438	195,00





WORKLIGHT PRO 120 PD, DALI

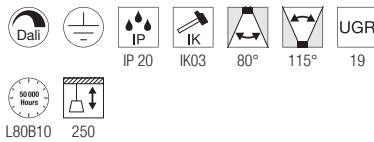
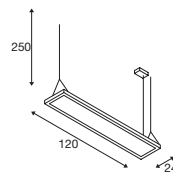

200-240V ~50/60Hz | 1200mA
Potenza assorbita: 50W
Materiale: alluminio/acciaio



Up 2800lm | 4000K
Down 3300lm

Versione	Articolo	EUR
● nero	1007468	499,00
○ bianco	1007469	499,00
● grigio	1007470	499,00

WORKLIGHT PRO 150 PD, DALI

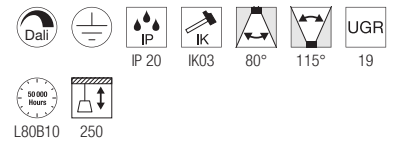
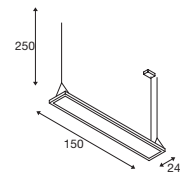

200-240V ~50/60Hz | 1400mA
Potenza assorbita: 59W
Materiale: alluminio/acciaio



Up 3300lm | 4000K
Down 3900lm

Versione	Articolo	EUR
● nero	1007471	599,00
○ bianco	1007472	599,00
● grigio	1007473	599,00

WORKLIGHT PD, DALI



NEW

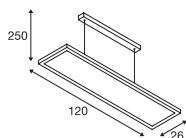

200-240V ~50/60Hz | 1550mA
Potenza assorbita: 57W
Materiale: alluminio



Up 2000lm | 4000K
Down 3000lm

Versione	Articolo	EUR
● nero	1005395	469,00
○ bianco	1005396	469,00
● argento	1006345	469,00

1006345 288





I-PENDANT PRO
PD, 1195x295mm, DALI

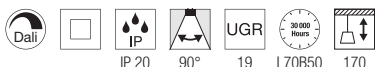
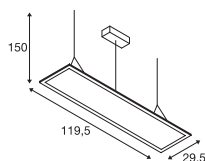

120-277V ~50/60Hz | 1000mA
Potenza assorbita: 43W
Materiale: alluminio/
polimetilmetacrilato (PMMA)



Down 3750lm | 3000K
3800lm | 4000K

Versione	Articolo	EUR
○ bianco 3750lm 3000K	1003048	373,00
○ bianco 3800lm 4000K	1003049	373,00
● grigio 3750lm 3000K	1003050	373,00
● grigio 3800lm 4000K	1003051	373,00



PANEL 60
PD, rotondo, DALI

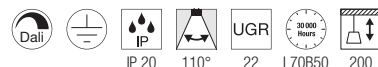
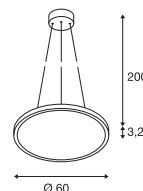

120-277V ~50/60Hz | 1000mA
Potenza assorbita: 43W
Materiale: alluminio/
polimetilmetacrilato (PMMA)



Down 3150lm | 3000K
3350lm | 4000K

Versione	Articolo	EUR
○ bianco 3150lm 3000K	1003044	324,00
○ bianco 3350lm 4000K	1003045	324,00
● grigio 3150lm 3000K	1003046	324,00
● grigio 3350lm 4000K	1003047	324,00



NOYA
PD, PHASE

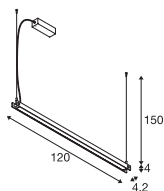

220-240V ~50/60Hz | 700mA
Potenza assorbita: 32W
Materiale: alluminio/polycarbonato (PC)



Down 1861lm | 2700K | 2025lm | 3000K

Versione	Articolo	EUR
● nero	1003530	479,00
○ bianco	1003532	479,00



1003530 290



1001403 291

GLENOS®
PD, 1m, 1-10V

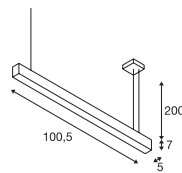

GLENOS®
PD, 2m, 1-10V

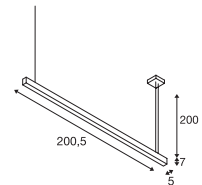

1001409 291

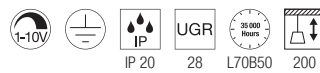

220-240V ~50/60Hz | 1000mA
Potenza assorbita: 43W
Materiale: alluminio/plastica



Down 2850lm | 3000K
3300lm | 4000K

Versione	Articolo	EUR
● nero		
2850lm 3000K	1001400	393,00
● nero		
3300lm 4000K	1001403	393,00

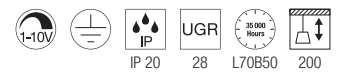

220-240V ~50/60Hz | 1000mA
Potenza assorbita: 85W
Materiale: alluminio/plastica



Down 5700lm | 3000K
6600lm | 4000K

Versione	Articolo	EUR
● nero		
5700lm 3000K	1001406	540,00
● nero		
6600lm 4000K	1001409	540,00



1000933 293



1000927 293



Q-LINE®
PD, 1m, BAP, PHASE

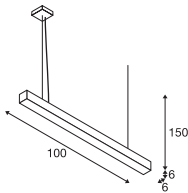

220-240V ~50/60Hz | 900mA
Potenza assorbita: 46W
Materiale: alluminio/plastica



Down 2100lm | 3000K
2300lm | 4000K

Versione	Articolo	EUR
● nero 2100lm 3000K	1000927	484,00
● nero 2300lm 4000K	1000933	484,00
○ bianco 2100lm 3000K	1000926	484,00
○ bianco 2300lm 4000K	1000932	484,00

Q-LINE®
PD, 2m, BAP, PHASE

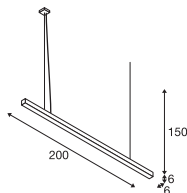

220-240V ~50/60Hz | 900mA
Potenza assorbita: 93W
Materiale: alluminio/plastica



Down 4200lm | 3000K
4600lm | 4000K

Versione	Articolo	EUR
● nero 4200lm 3000K	1000930	726,00
● nero 4600lm 4000K	1000936	726,00
○ bianco 4200lm 3000K	1000929	726,00
○ bianco 4600lm 4000K	1000935	726,00

Q-LINE®
PD, DALI, single

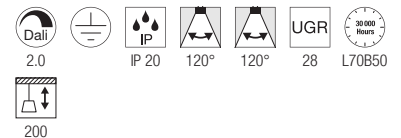
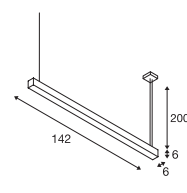

220-240V ~50/60Hz | 700mA
Potenza assorbita: 47W
Materiale: alluminio/acrilico



Down 3700lm | 3000K

Versione	Articolo	EUR
● nero	1001309	580,00
○ bianco	1001310	580,00

OCULUS
PD, single, PHASE

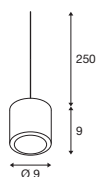

220-240V ~50/60Hz | 250mA

Potenza assorbita: 11W

Materiale: alluminio/vetro

- Inclusa lente smerigliata aggiuntiva
- Accessori abbinabili a pag. 295
- Cavo con terminale aperto



Down 36lm | 2000K - 780lm | 3000K

Versione	Articolo	EUR
● nero	1004672	209,00
○ bianco	1004673	209,00

1004672 294



132690 295

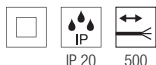
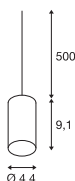

FITU
PD, E27

220-240V ~50/60Hz
Materiale: alluminio

- Cavo in tessuto
- Accessori abbinabili a pag. 295
- Cavo con terminale aperto

SOCKET INSIDE  **<60 W**

Attacco: 1xE27

Versione	Articolo	EUR
● nero	132690	60,00
○ bianco	132691	60,00



A60 | 7,5W | 320°
2700K | 800lm | Classe=F
8kWh/1000h



Articolo: 1005303 | 9,60 EUR

Rosone FITU singolo

16A max.
Acciaio
H: 3,9 cm
Ø: 8,5 cm
Incluso serracavo



Versione	Articolo	EUR
● nero	132600	26,00
○ bianco	132601	26,00
● oro	1002163	28,50
● cromo	132605	28,50

Rosone FITU a 3 punti rotondo

16A max.
Acciaio
H: 5,4 cm
Ø: 22 cm
Incluso serracavo



Versione	Articolo	EUR
● nero	132610	63,00
○ bianco	132611	63,00

Rosone

16A max.
Acciaio
H: 2,6 cm
Ø: 9 cm



Versione	Articolo	EUR
● nero	1004744	34,00
○ bianco	1004745	34,00
● oro	1006377	37,25
● cromo	1004746	37,25

Rosone a incasso

16A max.
Acciaio/Poliammide 66 (PA 66)
H: 3,3 cm
Ø: 8,5 cm



Versione	Articolo	EUR
● nero	1004674	22,50
○ bianco	1004675	22,50
● oro	1006378	27,00
● cromo	1004676	27,00

Gancio a soffitto

Alluminio
L: 4,6 cm
Ø: 1,8 cm



Versione	Articolo	EUR
● nero	132670	19,20
○ bianco	132671	19,20

Adattatore monofase

6A max.
Policarbonato (PC)
L: 8,5 cm La: 3,5 cm H: 3,2 cm
carico meccanico max 2 kg



Versione	Articolo	EUR
● nero	143120	15,00
○ bianco	143121	15,00
● grigio	143124	15,00

Adattatore trifase

10A max.
Plastica
L: 9,6 cm La: 3,5 cm H: 4,5 cm
carico meccanico max 5 kg



Versione	Articolo	EUR
● nero	145990	19,70
○ bianco	1001542	19,70
● grigio	145994	19,70

Gancio serracavo

Alluminio
L: 3,1 cm
Ø: 1,4 cm



Versione	Articolo	EUR
● nero	132680	12,50
○ bianco	132681	12,50

FENDA
PD, E27

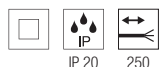
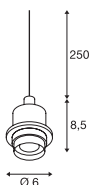

220-240V ~50/60Hz
Materiale: acciaio/plastica

- Accessori abbinabili a pag. 295
- Cavo con terminale aperto



Attacco: 1xE27

Versione	Articolo	EUR
● nero	132660	29,25
○ bianco	132661	29,25
● cromo	132662	33,00



A60 | 7,5W | 320°
2700K | 800lm | Classe=F
8kWh/1000h



Articolo: 1005303 | 9,60 EUR

FENDA
Diffusore in vetro



H: 20 cm
Ø: 12,5 cm
Materiale: vetro

FENDA
15 cm, rotondo



H: 40 cm
Ø: 15 cm
Materiale: tessuto/acciaio

Versione	Articolo	EUR
● fumè	1000773	65,00

Versione	Articolo	EUR
● nero/rame	156152	53,00
○ bianco	156141	44,75
● grigio	1004773	44,75
● beige	156143	44,75

155560 + 1000773 296





FENDA

30 cm, rotondo



H: 20 cm
 Ø: 30 cm
 Materiale: tessuto/acciaio

FENDA

Ø 45 cm, rotondo



H: 28 cm
 Ø: 45,5 cm
 Materiale: tessuto/acciaio

FENDA

Ø 70 cm, rotondo



H: 36 cm
 Ø: 70 cm
 Materiale: tessuto/acciaio

• Non adatto a Fenda Bow.

Versione	Articolo	EUR
●● nero/rame	155592	70,00
○ bianco	155582	53,00
● grigio	1004774	53,00
● beige	155583	53,00

Versione	Articolo	EUR
●● nero/rame	156122	88,00
○ bianco	156111	83,00
● grigio	1004775	83,00
● beige	156113	83,00

Versione	Articolo	EUR
●● nero/rame	1000580	129,00
○ bianco	1000579	112,00



Articolo	Articolo	EUR
Copertura in vetro acrilico	156100	44,50



Articolo	Articolo	EUR
Copertura in vetro acrilico	1000957	94,00



155561 + 1000579 296 + 297

MIX & MATCH FENDA

FENDA Ø15

Nero	156152
Bianco	156141
Beige	156143
Grigio	1004773

FENDA Ø30

Nero	155592
Bianco	155582
Beige	155583
Grigio	1004774

FENDA Ø45

Nero	156122
Bianco	156111
Beige	156113
Grigio	1004775

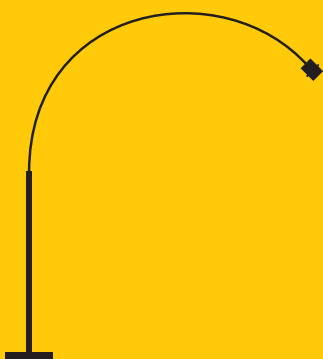

FENDA BOW

Nero	1003029
Cromo	1000763



FENDA TL

Nero	155780
------	--------



FENDA FL

Nero	155790
------	--------



FENDA TL

Nero	155540
------	--------

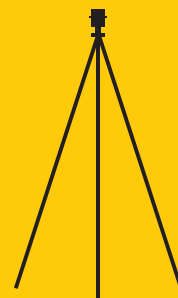

FENDA FL

Nero	155490
------	--------

Combina tra loro i prodotti Mix & Match a tuo piacimento, sono fatti gli uni per gli altri! Potrai mescolarli all'interno della famiglia FENDA o persino abbinare gli articoli FENDA e FITU. I prodotti Mix & Match sono contassegnati dal seguente simbolo:



MIX
match

FENDA Ø70

Nero | 1000580
Bianco | 1000579

FENDA Ø12,5

Glass Shade

Marrone | 1000773

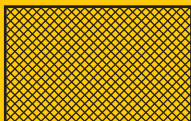

FENDA PD

Nero | 132660
Bianco | 132661
Cromo | 132662

FENDA CL

Nero | 155550
Bianco | 155551

FITU CRANE BASE

Nero | 1004682



FITU PD

Nero | 132690
Bianco | 132691

HELIA AMBIENT 35 PD, PHASE

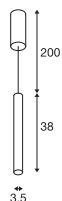

L70B50 200

220-240V ~50/60Hz | 500mA
Potenza assorbita: 9W
Materiale: alluminio/acrilico



Down 425lm | 3000K

Versione	Articolo	EUR
● nero	1003436	219,00

HELIA AMBIENT 35 PD

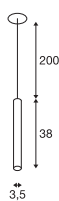
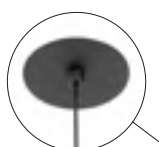

3 cm



L70B50 200

500mA
Potenza assorbita: 7,5W
Materiale: alluminio/acrilico

- Cavo con terminale aperto
- Ø rosone a incasso 68 mm



Down 425lm | 3000K

Versione	Articolo	EUR
● nero	1003435	179,00



Articolo	Articolo	EUR
Driver LED 20W 350mA/500mA PHASE		
○ bianco	1007227	● 40,00
Driver LED 25W 150-700mA dimmerabile DALI		
○ bianco	1007229	● 70,00
Driver LED 21W 500mA		
○ bianco	1007226	● 30,00



1003436 300



HELIA 30 PD, PHASE

HELIA 30 PD

152360 301

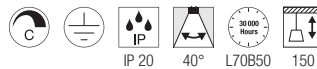
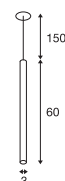
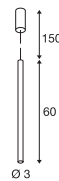

220-240V ~50/60Hz | 500mA
Potenza assorbita: 9,2W
Materiale: alluminio

500mA
Potenza assorbita: 7,5W
Materiale: alluminio

- incl. rosone a incasso
- Spessore del materiale della superficie di incasso: max. 12 mm
- Ø rosone a incasso 68 mm



Down 590lm | 3000K

Down 500lm | 3000K

Versione	Articolo	EUR
● nero	152360	219,00

Versione	Articolo	EUR
● nero	158400	179,00



Articolo	Articolo	EUR
Driver LED 20W 350-500mA PHASE		
○ bianco	1007227	40,00
Driver LED 25W 150-700mA dimmerabile DALI		
○ bianco	1007229	70,00
Driver LED 21W 500mA		
○ bianco	1007226	30,00

152370 303





HELIA 40 PD, PHASE

HELIA 40 PD

158400 303

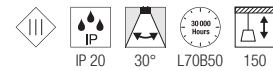
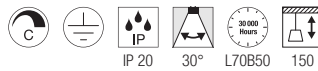
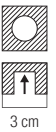
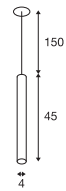
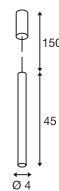

220-240V ~50/60Hz | 500mA
Potenza assorbita: 10W
Materiale: alluminio

500mA
Potenza assorbita: 9W
Materiale: alluminio

- incl. rosone a incasso
- Spessore del materiale della superficie di incasso: max. 12 mm
- Ø rosone a incasso 68 mm



Down 730lm | 3000K

Down 700lm | 3000K

Versione	Articolo	EUR
● nero	152370	249,00

Versione	Articolo	EUR
● nero	158410	199,00



Articolo	Articolo	EUR
Driver LED 20W 350-500mA PHASE		
○ bianco	1007227	● 40,00
Driver LED 25W 150-700mA dimmerabile DALI		
○ bianco	1007229	● 70,00
Driver LED 21W 500mA		
○ bianco	1007226	● 30,00



149388 305



ASTINA PD, QPAR51

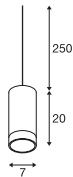

220-240V ~50/60Hz
Materiale: alluminio

- Cavo con terminale aperto



Attacco: 1xGU10

Versione	Articolo	EUR
● nero	1002939	117,00
○ bianco	1002937	117,00



LED GU10 51mm | 6W | 36°
2200-2700K | 360lm | Classe=G
6kWh/1000h



Articolo: 1005273 | 9,99 EUR

ENOLA B PD, QPAR51

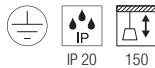

220-240V ~50/60Hz
Materiale: alluminio/acciaio



Attacco: 1xGU10

Versione	Articolo	EUR
● nero	151850	110,00
○ bianco	151851	110,00
● oro	151853	115,00



LED GU10 51mm | 6W | 38°
2700K | 450lm | Classe =F
6kWh/1000h



Articolo: 1005077 | 7,50 EUR

ENOLA PD, E27

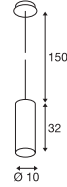

220-240V ~50/60Hz
Materiale: alluminio/acciaio



Attacco: 1xE27

Ø max.: 9 cm

L: 18 cm

Versione	Articolo	EUR
● nero	149388	81,00
○ bianco	149381	81,00
● oro	149387	94,00



LED E27 | 13,2W | 220°
2700K | 1300lm | Classe=F
13kWh/1000h



Articolo: 1005302 | 12,25 EUR



Articolo	Articolo	EUR
Adattatore monofase		
● nero	143120	15,00
○ bianco	143121	15,00
● grigio	143124	15,00
Adattatore trifase		
● nero	145990	19,70
● grigio	145994	19,70
○ bianco	1001542	19,70
Rosone FITU singolo		
● nero	132600	26,00
● cromo	132605	28,50
Rosone FITU singolo		
○ bianco	132601	26,00
Rosone FITU a 3 punti, rotondo		
● nero	132610	63,00
○ bianco	132611	63,00

ANELA
PD, PHASE

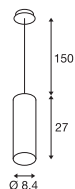

LISENNE
PD, E27

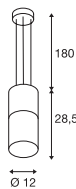

1000813 306



155714 306

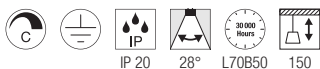

220-240V ~50/60Hz | 500mA
Potenza assorbita: 10W
Materiale: alluminio

- Riflettore escluso
- Flusso luminoso con riflettore 1000809: 500lm / Flusso luminoso con riflettore 1000810: 620lm / Flusso luminoso con riflettore 1000811: 200lm / Flusso luminoso con riflettore 1000812: 600lm



Down 220lm | 3000K 750lm |

Versione	Articolo	EUR
● nero	1000813	189,75



Articolo	Articolo	EUR
Riflettore 28°		
● nero	1000811	19,75
○ bianco	1000812	19,75
● oro	1000809	19,75
● argento	1000810	19,75

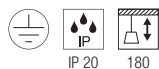

220-240V ~50/60Hz
Materiale: basalto/vetro



Attacco: 1xE27 Ø max.: 5,9 cm L: 15 cm

Versione	Articolo	EUR
● grigio/fumè	155714	241,00



LED E27 | 8W | 240°
3000K | 880lm | Classe=E
8kWh/1000h

Articolo: 1005289 | 10,25 EUR





133444 307

TONGA® PD, E14

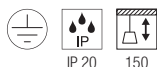
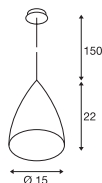

220-240V ~50/60Hz
Materiale: alluminio/vetro



Attacco: 1xE14 max. Ø: 5,1 cm | L: 13 cm

Versione	Articolo	EUR
● grigio	133444	129,00



C35 | 4,2W | 320°
2700K | 350lm | Classe=G
5kWh/1000h



Articolo: 1005285 | 8,50 EUR

QUADRASS PD, E27

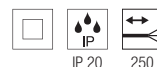
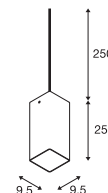

220-240V ~50/60Hz
Materiale: acciaio/vetro

- Cavo con terminale aperto



Attacco: 1xE27 Ø max.: 6,5 cm | L: 18 cm

Versione	Articolo	EUR
● cromo	1003432	104,00



LED E27 | 13,2W | 220°
2700K | 1300lm | Classe=F
13kWh/1000h



Articolo: 1005302 | 12,25 EUR



Articolo	Articolo	EUR
Adattatore monofase		
○ bianco	143121	15,00
Adattatore trifase		
○ bianco	1001542	19,70
Rosone FITU singolo		
○ bianco	132601	26,00

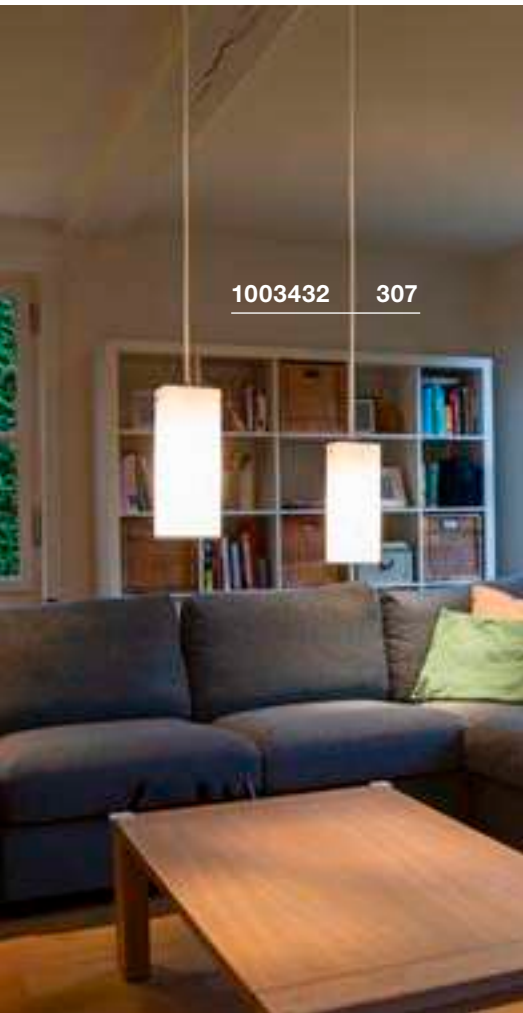

1003432 307



1006159 309



133019 309



133060 309



PARA CONE GL PD, GU10

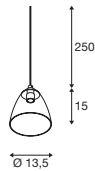

220-240V ~50/60Hz
Materiale: alluminio/vetro

- Cavo con terminale aperto



Attacco: 1xGU10

Versione	Articolo	EUR
● nero	1006159	84,00
○ bianco	1006160	84,00



LED GU10 51mm | 6W | 38°
2700K | 450lm | Classe =F
6kWh/1000h



Articolo: 1005077 | 7,50 EUR

PARA CONE 20 PD, E27

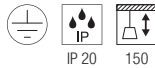
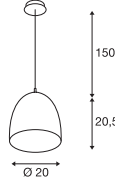

220-240V ~50/60Hz
Materiale: alluminio/acciaio

- Cavo in tessuto
- Versione nero/oro con riflettore dorato
- Tutte le altre versioni con riflettore bianco



Attacco: 1xE27

Versione	Articolo	EUR
●● nero/oro	133050	117,00
● rame	133009	164,00



A60 | 7,5W | 320°
2700K | 800lm | Classe=F
8kWh/1000h



Articolo: 1005303 | 9,60 EUR

PARA CONE 30 PD, E27

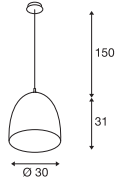

220-240V ~50/60Hz
Materiale: alluminio/acciaio

- Cavo in tessuto
- Versione nero/oro con riflettore dorato
- Tutte le altre versioni con riflettore bianco



Attacco: 1xE27

Versione	Articolo	EUR
●● nero/oro	133060	198,00
● rame	133019	222,00



A60 | 7,5W | 320°
2700K | 800lm | Classe=F
8kWh/1000h



Articolo: 1005303 | 9,60 EUR



Articolo	Articolo	EUR
Adattatore monofase		
● nero	143120	15,00
○ bianco	143121	15,00
● grigio	143124	15,00
Adattatore trifase		
● nero	145990	19,70
● grigio	145994	19,70
○ bianco	1001542	19,70
Rosone		
● nero	1004744	34,00
○ bianco	1004745	34,00
● cromo	1004746	37,25
Rosone a incasso		
● nero	1004674	22,50
○ bianco	1004675	22,50
Rosone FITU singolo		
● nero	132600	26,00
● cromo	132605	28,50
Rosone FITU singolo		
○ bianco	132601	26,00



1002949 311

1002951 310

1002950 311



1002949 311

PHELIA 10 PD, E27

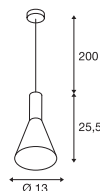

220-240V ~50/60Hz
Materiale: alluminio

- Cavo in tessuto



Attacco: 1xE27

Versione	Articolo	EUR
● nero/oro	1002951	131,00



A60 | 7,5W | 180°
2700K | 720lm | Classe=F
8kWh/1000h



Articolo: 1005305 | 19,00 EUR



PHELIA 20 PD, E27

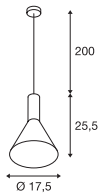

220-240V ~50/60Hz
Materiale: alluminio

- Cavo in tessuto



Attacco: 1xE27

Versione	Articolo	EUR
●● nero/oro	1002948	141,00



LED E27 | 13,2W | 220°
2700K | 1300lm | Classe=F
13kWh/1000h



Articolo: 1005302 | 12,25 EUR

PHELIA 25 PD, E27

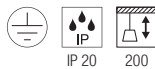
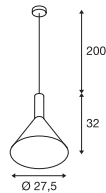

220-240V ~50/60Hz
Materiale: alluminio

- Cavo in tessuto



Attacco: 1xE27

Versione	Articolo	EUR
●● nero/oro	1002949	161,00



LED E27 | 13,2W | 220°
2700K | 1300lm | Classe=F
13kWh/1000h



Articolo: 1005302 | 12,25 EUR

PHELIA 30 PD, E27

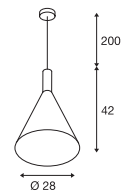

220-240V ~50/60Hz
Materiale: alluminio

- Cavo in tessuto



Attacco: 1xE27

Versione	Articolo	EUR
●● nero/oro	1002950	187,00



G125 | 7,5W | 320°
2700K | 800lm | Classe=F
8kWh/1000h



Articolo: 1005310 | 18,50 EUR

FORCHINI 50
PD, E27

FORCHINI 70
PD, E27

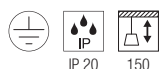
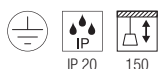
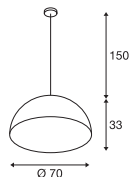
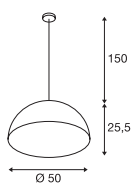

220-240V ~50/60Hz
Materiale: vetroresina

220-240V ~50/60Hz
Materiale: vetroresina

- Cavo in tessuto

- Cavo in tessuto



Attacco: 1xE27 max. L: 20 cm

Attacco: 1xE27 max. L: 20 cm

Versione	Articolo	EUR
●● nero/oro	155530	228,00

Versione	Articolo	EUR
●● nero/oro	1001701	403,00



A60 | 7,5W | 180°
2700K | 720lm | Classe=F
8kWh/1000h



Articolo: 1005305 | 19,00 EUR



LED E27 | 13,2W | 220°
2700K | 1300lm | Classe=F
13kWh/1000h



Articolo: 1005302 | 12,25 EUR

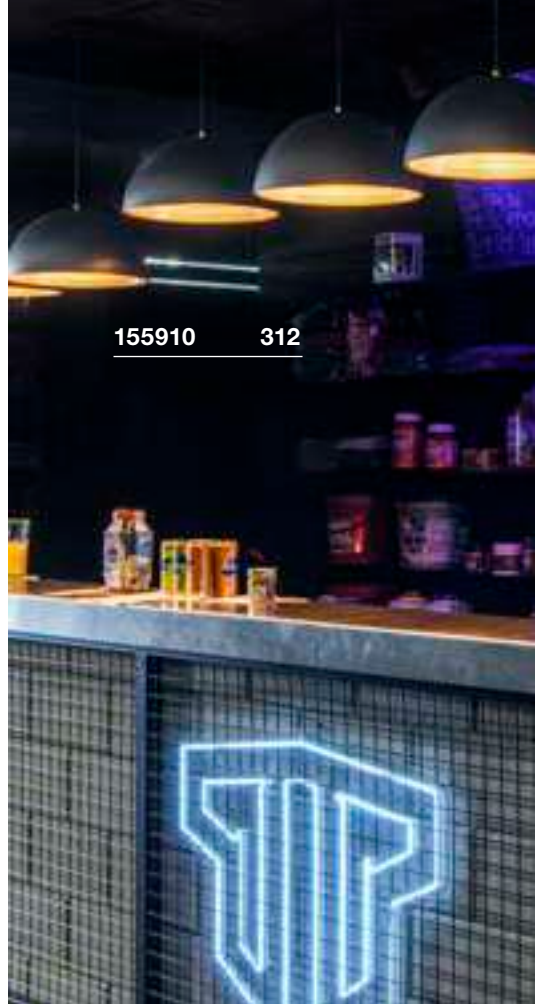

155910 312



1001701 311



FORCHINI M 40
PD, E27

FORCHINI M 50
PD, E27

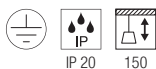
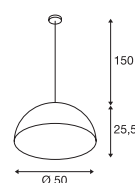
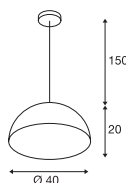
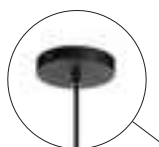

IP 20 150

220-240V ~50/60Hz
Materiale: alluminio/acciaio

- Cavo in tessuto



Attacco: 1xE27

max. L: 15,2 cm

Versione	Articolo	EUR
●● nero/oro	155910	228,00



A60 | 7,5W | 180°
2700K | 720lm | Classe=F
8kWh/1000h



Articolo: 1005305 | 19,00 EUR

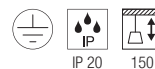

IP 20 150

220-240V ~50/60Hz
Materiale: alluminio/acciaio

- Cavo in tessuto



Attacco: 1xE27

max. L: 18 cm

Versione	Articolo	EUR
●● nero/oro	155930	251,00



LED E27 | 13,2W | 220°
2700K | 1300lm | Classe=F
13kWh/1000h



Articolo: 1005302 | 12,25 EUR

LIGHT EYE® 90
PD, GU10

LIGHT EYE® 150
PD, QPAR111

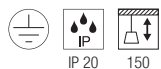
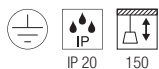

220-240V ~50/60Hz
Materiale: acciaio

220-240V ~50/60Hz
Materiale: acciaio

- Cavo in tessuto

- Cavo in tessuto



Attacco: 1xGU10

Attacco: 1xGU10

Versione	Articolo	EUR
● nero/cromo	133490	84,00

Versione	Articolo	EUR
○ bianco/cromo	133481	119,00
● cromo	133482	127,00
● rame	133489	155,00



LED GU10 51mm | 5W | 38°
2700-6500K | 350lm | Classe=G
5kWh/1000h

Articolo: 1005311 | 37,75 EUR

QPAR111 | 12,5W | 30°
2700K | 950lm | Classe=F
13kWh/1000h

Articolo: 1005276 | 49,50 EUR

⊕

Articolo	Articolo	EUR
Anello decorativo Ø 5,7cm		
● nero	151040	5,30
○ bianco	151041	5,30
● cromo	151049	7,75

SUN / BIG SUN
PD, E27

1002045 315

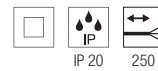
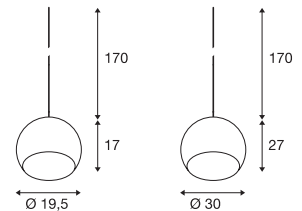
220-240V ~50/60Hz
Materiale: acciaio/vetro

- Accessori abbinabili a pag. 295
- Cavo con terminale aperto

SOCKET **INSIDE** <60
W

Attacco: 1xE27 | Ø max.: 7 cm | L: 12 cm

Versione	Articolo	EUR
○ 1xE27 Ø: 19,5 cm	1002045	91,00
○ 1xE27 Ø: 30 cm	1002046	171,00

A60 | 7,5W | 320°
2700K | 800lm | Classe=F
8kWh/1000hArticolo: **1005303** | **9,60 EUR**



165410 317



165400 317



165390 317



ROTOBALL 25 PD, E27



220-240V ~50/60Hz
Materiale: acciaio/polietilene (PE)



Attacco: 1xE27 Ø max.: 7 cm

Versione	Articolo	EUR
○ bianco	165390	161,00



LED E27 | 13,2W | 220°
2700K | 1300lm | Classe=F
13kWh/1000h



Articolo: **1005302** | **12,25 EUR**

ROTOBALL 40 PD, E27

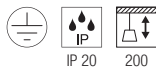

220-240V ~50/60Hz
Materiale: acciaio/polietilene (PE)



Attacco: 1xE27 Ø max.: 9,5 cm

Versione	Articolo	EUR
○ bianco	165410	181,00



LED E27 | 13,2W | 220°
2700K | 1300lm | Classe=F
13kWh/1000h



Articolo: **1005302** | **12,25 EUR**

ROTOBALL 50 PD, E27

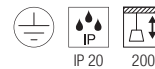

220-240V ~50/60Hz
Materiale: acciaio/polietilene (PE)



Attacco: 1xE27 Ø max.: 9,5 cm

Versione	Articolo	EUR
○ bianco	165400	222,00



LED E27 | 13,2W | 220°
2700K | 1300lm | Classe=F
13kWh/1000h



Articolo: **1005302** | **12,25 EUR**

PARA DOME PD, E27

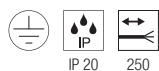
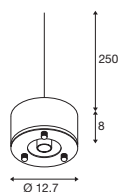

220-240V ~50/60Hz
Materiale: alluminio

- Cavo con terminale aperto



Attacco: 1xE27 Ø max.: 7 cm

Versione	Articolo	EUR
● nero	1005214	82,00
● grigio	1005215	82,00

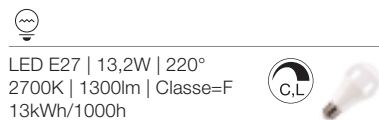

LED E27 | 13,2W | 220°
2700K | 1300lm | Classe=F
13kWh/1000h

Articolo: 1005302 | 12,25 EUR

Articolo	Articolo	EUR
Adattatore monofase		
● nero	143120	15,00
Adattatore trifase		
● nero	145990	19,70
Rosone		
● nero	1004744	34,00
Rosone quadrato		
● nero	210060	32,00
Rosone FITU		
● nero	132600	26,00

PARA DOME Diffusore



NEW



H: 20,6 cm
Ø: 30,8 cm
Materiale: alluminio

Versione	Articolo	EUR
● nero	1005216	100,00
● nero/oro	1006410	100,00
● grigio	1005217	100,00

PARA DOME Diffusore



H: 20 cm
Ø: 31,5 cm
Materiale: policarbonato (PC)

Versione	Articolo	EUR
○ trasparente	1005218	100,00



165358 319



165359 319



PARA 380

PD, E27

165359

319

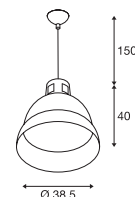

220-240V ~50/60Hz
Materiale: alluminio

SOCKET INSIDE <20 W

Attacco: 1xE27

Versione	Articolo	EUR
● nero	165359	165,00
● alluminio	165358	168,00



LED E27 | 13,2W | 220°
2700K | 1300lm | Classe=F
13kWh/1000h



Articolo: 1005302 | 12,25 EUR

1007612 325





LED
LYGANT | 325



LED
LYGANT | 325



SOCKET
VARYT | 327



LED
SEDO 7 | 329



LED
SEDO 14 | 329



LED
SEDO 21 | 329



LED
TRUKKO | 330



LED
TRUKKO | 330



LED
TRUKKO | 331



LED
TRUKKO 80 | 331



LED
TRUKKO 60 | 332



LED
TRUKKO 90 | 332



LED
MARYLIN 40 | 333



LED
WL 149 | 334



SOCKET
WL 149 | 334



SOCKET
WL 106 | 335



SOCKET
WL 106 | 335



SOCKET
MIBO UP/DOWN | 337



LED
MAGANDA | 337



LED
DORISA 30 | 339



LED
DORISA 50 | 339



LED
GLENOS® 60 | 339



LED
L-LINE 60 | 341



LED
L-LINE 120 | 341



LED
Q-LINE® | 341



SOCKET
PANTILO ROPE | 345



SOCKET
ASTO TUBE | 347



SOCKET
ASTO TUBE | 347



LED
MANA BASE | 349



LED
MANA BASE | 349



LED
MANA 40 | 319



LED
MANA 60 | 349



LED
MANA | 351



LED
MANA | 351



LED
MANA | 351



LED
MANA | 353



LED
MANA | 353



LED
MANA | 353

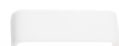

LED
MANA | 353



LED
OCULUS | 355



LED
OCULUS
UP/DOWN | 355



SOCKET
PLASTRA | 356



SCKET
PLASTRA | 356



SCKET
PLASTRA | 357



SCKET
PLASTRA | 357



SCKET
PLASTRA | 359



LED
PLASTRA | 359



LED
PLASTRA | 359



SCKET
PLASTRA | 360



SCKET
PLASTRA 101 | 361



SCKET
PLASTRA | 361



SCKET
PLASTRA 104 | 361



LED
LOGS IN | 362



LED
LOGS IN | 362



LED
LOGS IN L | 363



LED
LOGS IN L | 363



LED
QUAD FRAME 14 | 364



LED
QUAD FRAME 19 | 364



LED
SHELL 15 | 365



LED
SHELL 30 | 365



LED
ASSO 300 | 366



LED
ASSO 300 | 367



SCKET
OSSA 180 | 367



SCKET
OSSA 300 | 367



LED
CARISO | 368



LED
CARISO | 368



LED
CHROMBO | 369



LED
DIRETO 60 | 370



LED
DIRETO 90 | 370



LED
ARLINA 60 | 371



LED
ARLINA 130 | 371



SCKET
ANDREAS | 373



SCKET
DENA 30 | 373



SCKET
BASKET | 373



SCKET
QUADRASS | 375



LED
QUADRASS
SPOT | 375



SCKET
LISENNE | 375



SCKET
FITU | 376



SCKET
FITU CUBE | 376



SCKET
THEO UP/DOWN | 377



SCKET
SOLID CUBE | 377



ENOLA B | 379



ENOLA B | 379



**ASTINA
UP/DOWN** | 379



SCKET

FENDA | 380



FENDA | 380



LED

KENKUA SPOT | 381



LED

COUPA FLEX | 381



LED

KARPO MAGN | 382



LED

KARPO GOOSE | 382



LED

KARPO 30 | 383



LED

KARPO | 383



LED

SOMNILA SPOT | 384



LED

SOMNILA SPOT | 385



LED

SOMNILA FLEX | 385



LED

SOMNILA FLEX | 385



SCKET

DIO FLEX PLATE | 387



LED

DIO FLEX PLATE | 387



LED

DIO FLEX PLATE | 387



SCKET

PHELIA | 388



LED

MERADO FLOOD | 388



SCKET

DISPLAY ADL 50 | 389

1007619 325





LYGANT WL, single

LYGANT WL, double

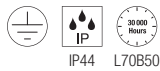
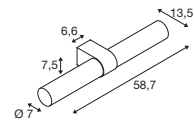
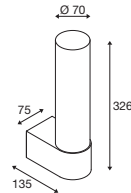

220-240V ~50/60Hz | 700mA
Potenza assorbita: 8W
Materiale: acciaio inox/vetro

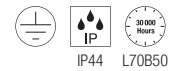

220-240V ~50/60Hz | 500mA
Potenza assorbita: 11W
Materiale: acciaio inox/vetro



Down 560lm | 3000K



Down 800lm | 3000K

Versione	Articolo	EUR
● nero	1007614	249,00
○ bianco	1007613	249,00
● ottone	1007612	279,00
● cromo	1007615	279,00

Versione	Articolo	EUR
● nero	1007618	359,00
○ bianco	1007617	359,00
● ottone	1007616	385,00
● cromo	1007619	385,00

1007603 327

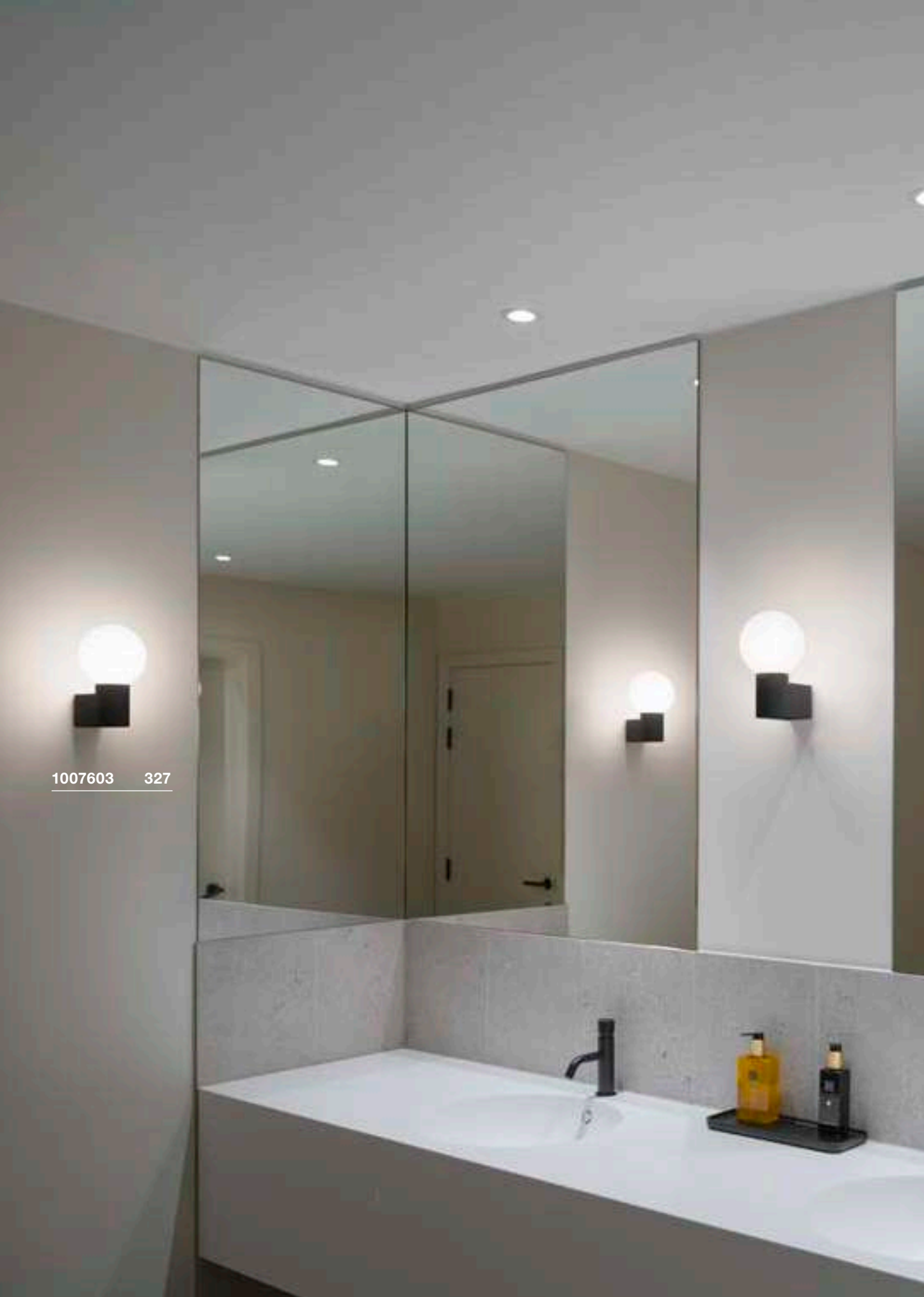



VARYT
WL, E14

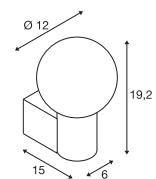

220-240V ~50/60Hz
 Materiale: acciaio inox/vetro 1007601
 Acciaio/vetro 1007603, 1007602, 1007600

SOCKET
INSIDE <6 W

Attacco: 1xE14 Ø max.: 5 cm L: 11 cm

Versione	Articolo	EUR
● nero	1007603	145,00
○ bianco	1007602	145,00
● ottone	1007601	179,00
● cromo	1007600	159,00



C35 | 4,2W | 320°
 2700K | 350lm | Classe=G
 5kWh/1000h



Articolo: 1005285 | 8,50 EUR

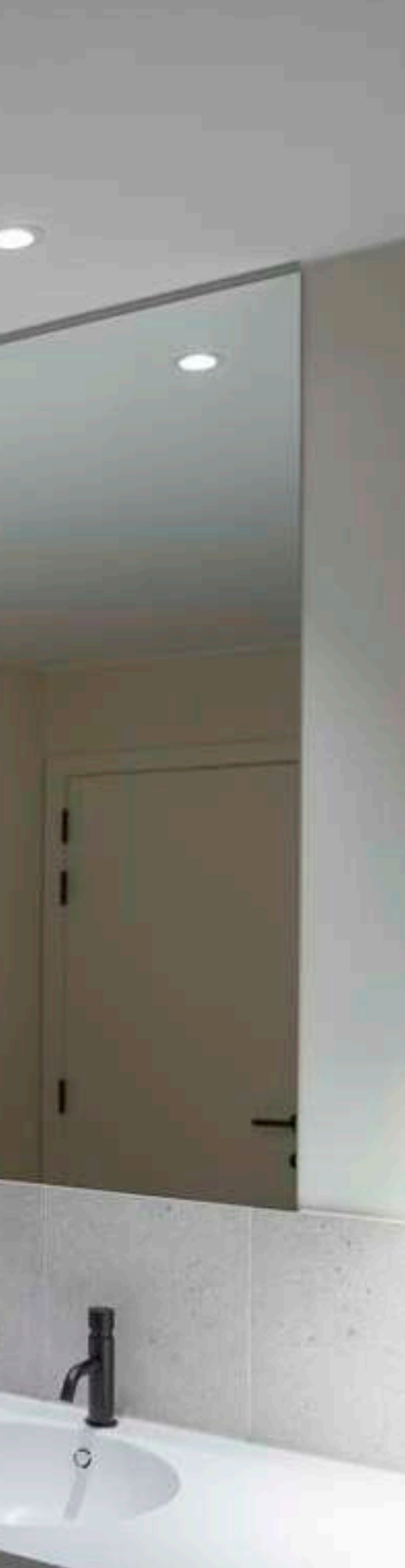



151796 329



1002964 329



SEDO 7 WL

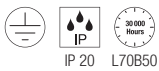
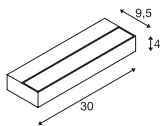

220-240V ~50/60Hz | 350mA
Potenza assorbita: 11,5 W
Materiale: alluminio/vetro



Down 1020lm | 3000K

Versione	Articolo	EUR
○ bianco	1002962	187,00
● alluminio	1002964	201,00

SEDO 14 WL

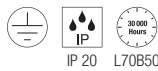
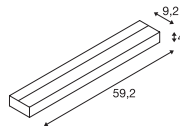

220-240V ~50/60Hz | 500mA
Potenza assorbita: 18W
Materiale: alluminio/vetro



Down 1300lm | 3000K

Versione	Articolo	EUR
○ bianco	151781	242,00
● alluminio	151786	252,00

SEDO 21 WL

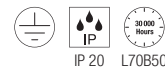
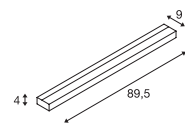

220-240V ~50/60Hz | 700mA
Potenza assorbita: 30W
Materiale: alluminio/vetro



Down 2500lm | 3000K

Versione	Articolo	EUR
○ bianco	151791	292,00
● alluminio	151796	302,00



1004729 330

TRUKKO WL, rettangolare

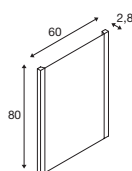
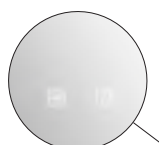

TRUKKO WL, rettangolare

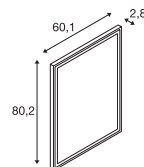

1004730 330



220-240V ~50/60Hz | 24V
Potenza assorbita: 24W
Materiale: vetro / alluminio

- Funzione disappannamento
- Temperatura del colore regolabile con tasto touch



1310lm | 3000K | 1320lm | 4000K | 1340lm | 6500K

Versione	Articolo	EUR
☉ argento / opalino	1004729	424,00



220-240V ~50/60Hz | 24V
Potenza assorbita: 25W
Materiale: vetro/plastica

- Funzione disappannamento
- Temperatura del colore regolabile con tasto touch



1080lm | 3000K | 1290lm | 4000K | 1250lm | 6500K

Versione	Articolo	EUR
☉ argento / opalino	1004730	383,00



1007201 331



TRUKKO
WL, rotondo

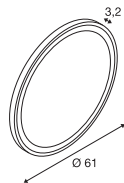
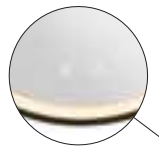

220-240V ~50/60Hz | 24V
Potenza assorbita: 25W
Materiale: vetro/ABS

- Funzione disappannamento
- Temperatura del colore regolabile con tasto touch



730lm | 3000K | 710lm | 4000K | 720lm | 6500K

Versione	Articolo	EUR
○ argento / opalino 1270/1260/1260lm	1004731	399,00
● trasparente/nero 730/710/720lm	1007201	399,00

TRUKKO 80
WL, rotondo

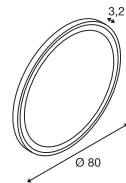

220-240V ~50/60Hz | 24V
Potenza assorbita: 23W
Materiale: vetro/ABS

- Funzione disappannamento
- Temperatura del colore regolabile con tasto touch



730lm | 3000K | 740lm | 4000K | 790lm | 6500K

Versione	Articolo	EUR
○ argento / opalino 1100/1130/1210lm	1007200	560,00
● trasparente/nero 730/740/790lm	1007202	560,00



1007202 331

TRUKKO 60
WL

TRUKKO 90
WL

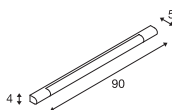
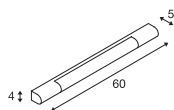

Articolo



220-240V ~50/60Hz | 500mA
Potenza assorbita: 9,2W
Materiale: alluminio/plastica



Down 750lm | 3000K

Versione	Articolo	EUR
● cromo	149762	161,00



220-240V ~50/60Hz | 500mA
Potenza assorbita: 12W
Materiale: alluminio/plastica



Down 1040lm | 3000K

Versione	Articolo	EUR
● cromo	149772	191,00

149772 332

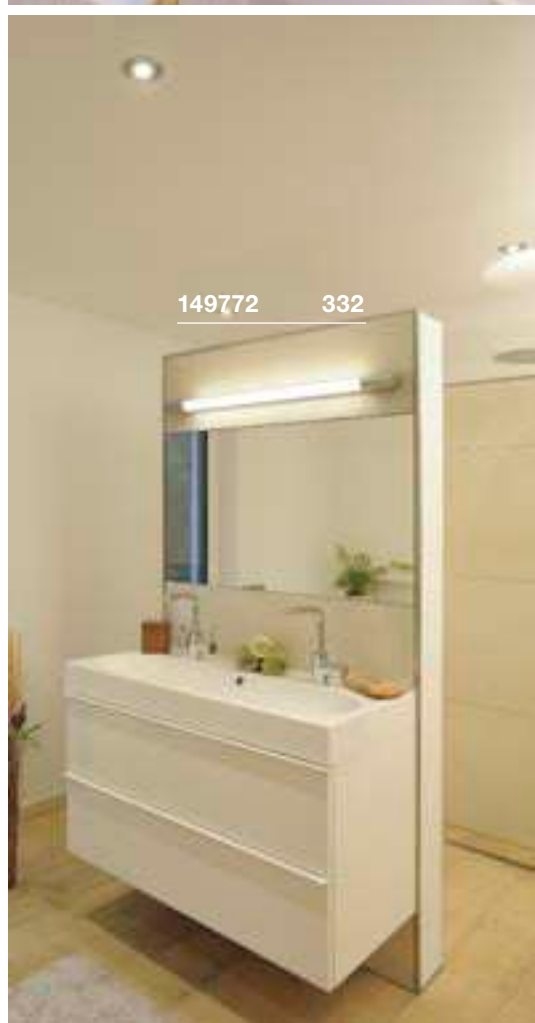

149772 332

**MARYLIN 40/60/90
WL**

1002191 333

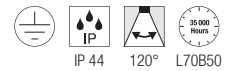
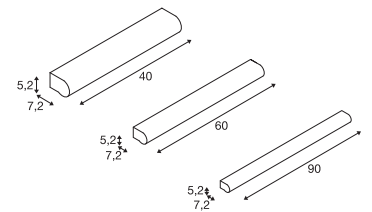

IP 44 120° L70B50

220-240V ~50/60Hz | 350mA

Potenza assorbita: 9,8W

Materiale: alluminio/polycarbonato (PC)



Down 890lm | 3000K | 980lm | 4000K

Versione	Articolo	EUR
● cromo L: 40 cm 890/980lm 9.8W	1002190	228,00
● cromo L: 60 cm 1170/1280lm 16W	1002191	286,00
● cromo L: 90 cm 1800/1990lm 21W	1002192	344,00

WL 149
WL, PHASE

WL 149
WL, QT-DE12

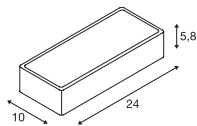
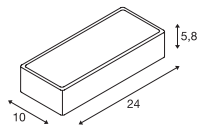

220-240V ~50/60Hz | 350mA
Potenza assorbita: 14W
Materiale: acciaio/vetro



220-240V ~50/60Hz
Materiale: acciaio/vetro



Down 1050lm | 3000K



Attacco: R7s 78mm

Versione	Articolo	EUR
<input type="radio"/> bianco	149511	151,00

Versione	Articolo	EUR
<input type="radio"/> bianco	149471	70,00



LED R7s | 9W | 330°
3000K | 1050lm | Classe=E
9kWh/1000h



Articolo: 1005287 | 24,00 EUR

149511 334



149471 334





WL 106
E14

WL 106
E14

1002228 335

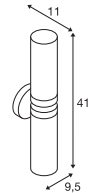
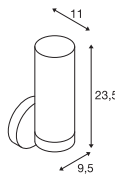

220-240V ~50/60Hz
Materiale: alluminio/vetro

220-240V ~50/60Hz
Materiale: alluminio/vetro



Attacco: 1xE14 Ø max.: 3,6 cm L: 11 cm

Attacco: 2xE14 Ø max.: 3,6 cm L: 11 cm

Versione	Articolo	EUR
● cromo	1002228	90,00

Versione	Articolo	EUR
● cromo	1002229	161,00



C35 | 4,2W | 320°
2700K | 350lm | Classe=G
5kWh/1000h



C35 | 4,2W | 320°
2700K | 350lm | Classe=G
5kWh/1000h



Articolo: 1005285 | 8,50 EUR

Articolo: 1005285 | 8,50 EUR

1004971 337





MIBO UP/DOWN WL, QT14

MAGANDA WL

151282 337

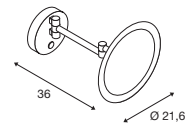
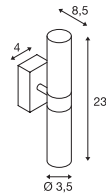

IP 21

220-240V ~50/60Hz
Materiale: alluminio/vetro



IP 44

IK02

L70B50

90°

100-240V ~50/60Hz | 12V
Potenza assorbita: 4,8W
Materiale: acciaio/vetro

- Temperatura della luce regolabile



Attacco: 2xGU9



45.4lm | 2700K | 48lm | 3000K | 51lm | 4000K

Versione	Articolo	EUR
● cromo	151282	89,00

Versione	Articolo	EUR
● cromo	1004971	203,00



LED G9 | 3,6W | 300°
3000K | 400lm | Classe=E
4kWh/1000h

Articolo: 1005286 | 9,99 EUR



1003507 339





DORISA 30 WL

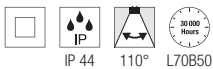
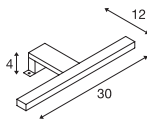

200-240V ~50Hz | 340mA
Potenza assorbita: 5,2W
Materiale: alluminio/plastica

- Apertura del morsetto: 0-6 mm
- Utilizzabile come lampada per specchiera smontando il supporto



Down 300lm | 4000K

Versione	Articolo	EUR
● cromo	1000777	115,00

DORISA 50 WL

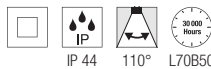
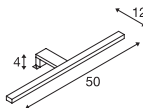

200-240V ~50Hz | 340mA
Potenza assorbita: 6,6W
Materiale: alluminio/plastica

- Apertura del morsetto: 0-6 mm
- Utilizzabile come lampada per specchiera smontando il supporto



Down 370lm | 4000K

Versione	Articolo	EUR
● cromo	1000780	127,00

GLENOS® 60 WL

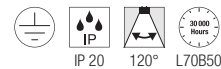
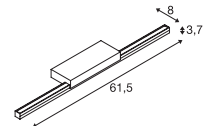

220-240V ~50/60Hz | 500mA
Potenza assorbita: 12W
Materiale: alluminio/polycarbonato (PC)



Down 1170lm | 3000K
4000K

Versione	Articolo	EUR
● nero	1003506	181,00
○ bianco	1003507	181,00
● grigio	1003508	181,00

1000669 341

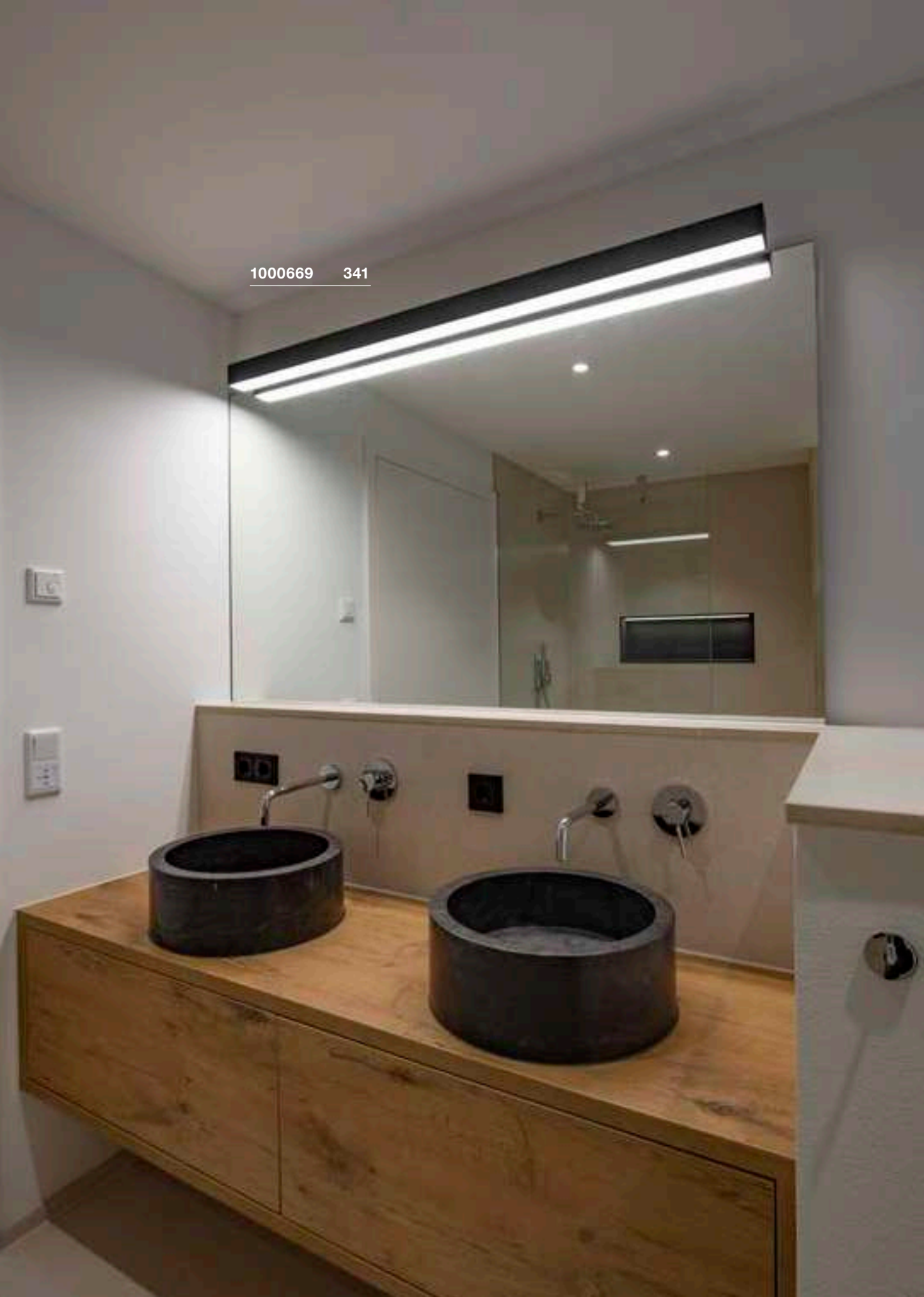



L-LINE 60
WL

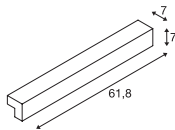

220-240V ~50/60Hz | 350mA
Potenza assorbita: 10W
Materiale: alluminio/policarbonato (PC)



Down 820lm | 3000K

Versione	Articolo	EUR
○ bianco	1001299	239,00
● argento	1001300	239,00

L-LINE 120
WL

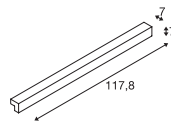

220-240V ~50/60Hz | 350mA
Potenza assorbita: 18,5W
Materiale: alluminio/policarbonato (PC)



Down 1650lm | 3000K

Versione	Articolo	EUR
○ bianco	1001303	330,00
● argento	1001304	330,00

Q-LINE®
WL

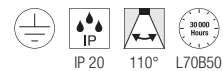
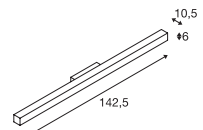

220-240V ~50/60Hz | 700mA
Potenza assorbita: 45W
Materiale: alluminio/acrilico



Down 3800lm | 3000K

Versione	Articolo	EUR
● nero	1000669	464,00
○ bianco	1000668	464,00
● grigio	1000670	464,00

CLASSI IP

Con la classe di protezione IP adatta alla zona di utilizzo non avrete alcun problema.



L'illuminazione in un moderno ambiente di benessere dovrebbe essere funzionale, rilassante e sicura, quindi è fondamentale scegliere il giusto grado di protezione IP a seconda di dove verranno utilizzati gli apparecchi.

La sigla IP è l'acronimo di «Ingress Protection», cioè protezione dall'ingresso di corpi solidi e liquidi. Il codice IP standard è composto da una prima cifra che indica la protezione dai corpi estranei solidi e una seconda che descrive la resistenza all'acqua e all'umidità. Quest'ultima è la caratteristica fondamentale per i bagni e gli ambienti esterni.

CORPI SOLIDI LIQUIDI

Nessuna protezione	0	0	Nessuna protezione
Protezione contro corpi solidi superiori a 50 mm di diametro	1	1	Protezione da caduta verticale di gocce d'acqua
Protezione contro corpi solidi superiori a 12 mm di diametro	2	2	Protezione da caduta di gocce d'acqua con inclinazione massima 15°
Protezione contro corpi solidi superiori a 2,5 mm di diametro	3	3	Protezione da caduta di gocce d'acqua con inclinazione massima 60°
Protezione contro corpi solidi superiori a 1 mm di diametro	4	4	Protezione da spruzzi d'acqua da tutte le direzioni
Protezione contro la polvere	5	5	Protezione da getti d'acqua da tutte le direzioni
Completamente protetto dalla polvere	6	6	Protezione da getti d'acqua potenti
		7	Protezione da immersioni temporanee
		8	Protezione da immersione continua

ESEMPIO IP 65:

Il prodotto ha la massima protezione contro la polvere (livello 6) e un'elevata protezione da getti d'acqua (livello 5). Può quindi essere classificato come a tenuta di polvere e resistente all'acqua.





PANTILO ROPE WL, G9

1007595 345



NEW

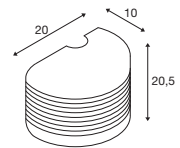

200-240V ~50/60Hz
Materiale: acciaio

**SOCKET
INSIDE** <15
W

Attacco: 1xGU9

Ø max.: 3 cm | L: 6 cm

Versione	Articolo	EUR
oro	1007595	179,00
argento	1007594	179,00



LED G9 | 3,6W | 300°
3000K | 400lm | Classe=E
4kWh/1000h

Articolo: 1005286 | 9,99 EUR





1006441 347



1006444 347



ASTO TUBE
WL, single, GU10

ASTO TUBE
WL, up/down, GU10

ASTO TUBE
Anello decorativo



H: 3,95 cm
Ø: 6,75 cm
Materiale: policarbonato (PC)

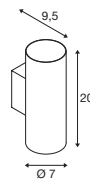
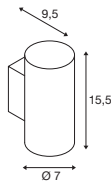

Versione	Articolo	EUR
● nero-cromo	1007190	4,00
● oro	1006450	4,00
● cromo	1006449	4,00
● rame	1006451	4,00



220-240V ~50/60Hz
Materiale: alluminio



Attacco: 1xGU10

Versione	Articolo	EUR
● nero	1006441	60,00
○ bianco	1006442	60,00



220-240V ~50/60Hz
Materiale: alluminio



Attacco: 2xGU10

Versione	Articolo	EUR
● nero	1006443	80,00
○ bianco	1006444	80,00



1004969 + 1004660 349



1004657 + 1004663 349





MANA BASE WL, rotondo, PHASE

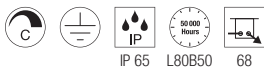
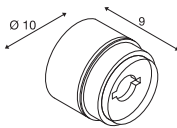

220-240V ~50/60Hz | 350mA
Potenza assorbita: 15W
Materiale: alluminio/policarbonato (PC)



Down 800lm | 2700K | 820lm | 3000K

Versione	Articolo	EUR
● antracite	1006319	189,00

MANA BASE rotondo

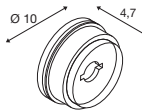

Materiale: alluminio/policarbonato (PC)

- Base non illuminata per i diffusori rotondi della serie MANA

Versione	Articolo	EUR
● antracite	1004969	26,00

MANA 40 Diffusore, rotondo



H: 6 cm
Ø: 40 cm
Materiale: feltro/alluminio

- Utilizzando più diffusori in feltro a parete è possibile ottenere un effetto fonoassorbente

Versione	Articolo	EUR
● grigio	1004661	99,00
● beige	1004660	99,00

MANA 60 Diffusore, rotondo



H: 6 cm
Ø: 60 cm
Materiale: feltro/alluminio

- Utilizzando più diffusori in feltro a parete è possibile ottenere un effetto fonoassorbente

Versione	Articolo	EUR
● grigio	1004663	145,00
● beige	1004662	145,00

1000613 + 1000824 351





MANA WL, Base, PHASE

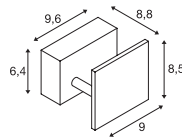

220-240V ~50/60Hz | 350mA
Potenza assorbita: 8,3W
Materiale: alluminio/acciaio



Down 520lm | 2000-3000K

Versione	Articolo	EUR
○ bianco	1000613	145,00

MANA Diffusore



IP 20

L: 12 cm H: 10 cm P: 9 cm
Materiale: legno

- adatto solo a 1000613

Versione	Articolo	EUR
○ bianco	1000618	51,00
● grigio/marrone	1000616	51,00

MANA Diffusore



IP 20

La: 13,6 cm H: 10 cm P: 9,5 cm
Materiale: gesso/acciaio

- adatto solo a 1000613
- Personalizzabile con pitture murali o tappezzeria

Versione	Articolo	EUR
○ bianco	1000824	36,00

1000615 + 1000823 353





MANA WL, Base, PHASE

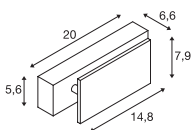

220-240V ~50/60Hz | 350mA
Potenza assorbita: 15W
Materiale: alluminio/acciaio



Down 700lm | 2000-3000K

Versione	Articolo	EUR
○ bianco	1000614	169,00

MANA WL, Base

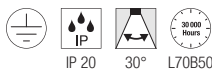
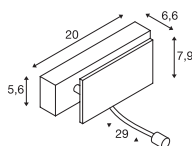

220-240V ~50/60Hz | 350/500mA
Potenza assorbita: 11W
Materiale: alluminio/acciaio



Down 650lm | 3000K

Versione	Articolo	EUR
○/● bianco/cromo	1000615	215,00

- Spot con accensione separata

MANA Diffusore



L: 29 cm H: 9.5 cm P: 7 cm
Materiale: legno

- adatto solo a 1000614/1000615

Versione	Articolo	EUR
○ bianco	1000623	61,00
● grigio/marrone	1000621	61,00

MANA Diffusore

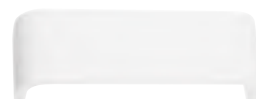

L: 30,9 cm H: 9.5 cm P: 7,4 cm
Materiale: gesso/acciaio

- adatto solo a 1000614/1000615
- Personalizzabile con pitture murali o tappezzeria

Versione	Articolo	EUR
○ bianco	1000825	33,75

1006308 355

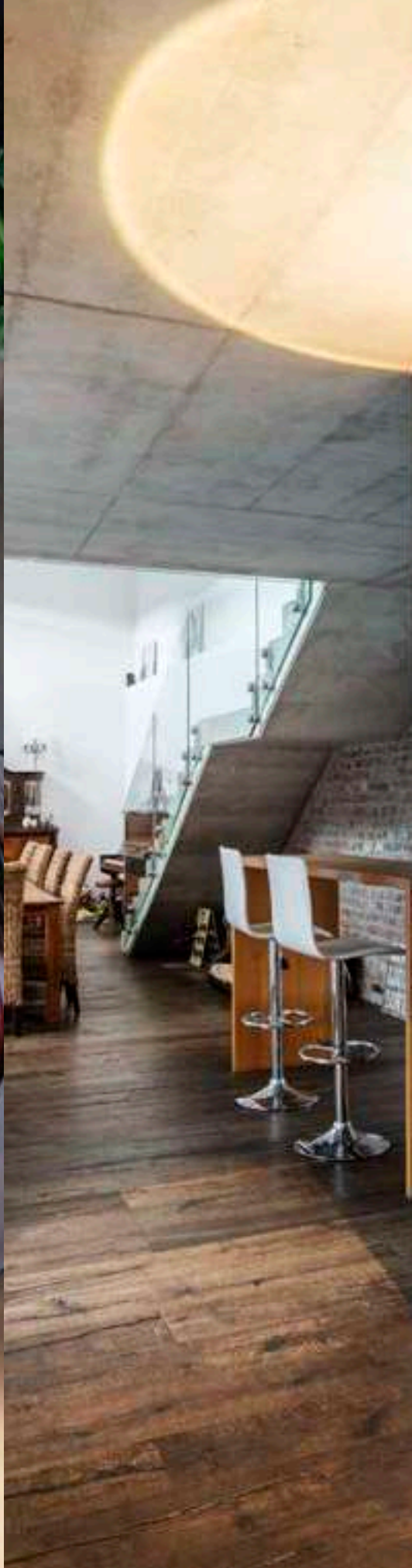



OCULUS WL, single, PHASE



OCULUS UP/DOWN WL, PHASE



1004671 355

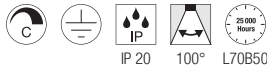
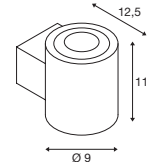
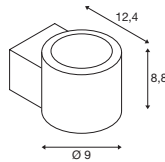

220-240V ~50/60Hz | 350mA
Potenza assorbita: 8,5W
Materiale: alluminio/vetro



220-240V ~50/60Hz | 700mA
Potenza assorbita: 15W
Materiale: alluminio/vetro

- Inclusa lente smerigliata aggiuntiva



Down 570lm | 2000-3000K



Up Down 22lm | 2000K - 555lm | 3000K

Versione	Articolo	EUR
● nero	1006307	229,00
○ bianco	1006308	229,00

Versione	Articolo	EUR
● nero	1004670	249,00
○ bianco	1004671	249,00

PLASTRA
WL, Cube, QT14

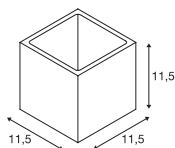
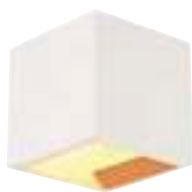

220-240V ~50/60Hz
Materiale: gesso/acciaio

- Personalizzabile con pitture murali o tappezzeria

SCKET **INSIDE** <42
W

Attacco: 1xGU9

Versione	Articolo	EUR
<input type="radio"/> bianco	148018	54,00



LED G9 | 3,6W | 300°
3000K | 400lm | Classe=E
4kWh/1000h

Articolo: **1005286** | **9,99 EUR**



PLASTRA
WL, Cubes

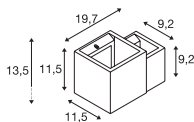
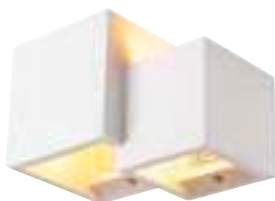

220-240V ~50/60Hz
Materiale: gesso/acciaio

- Personalizzabile con pitture murali o tappezzeria

SCKET **INSIDE** 15
W

Attacco: 2xGU9 Ø max.: 7 cm L: 4 cm

Versione	Articolo	EUR
<input type="radio"/> bianco	1004733	59,00



LED G9 | 3,6W | 300°
3000K | 400lm | Classe=E
4kWh/1000h

Articolo: **1005286** | **9,99 EUR**



148018 356

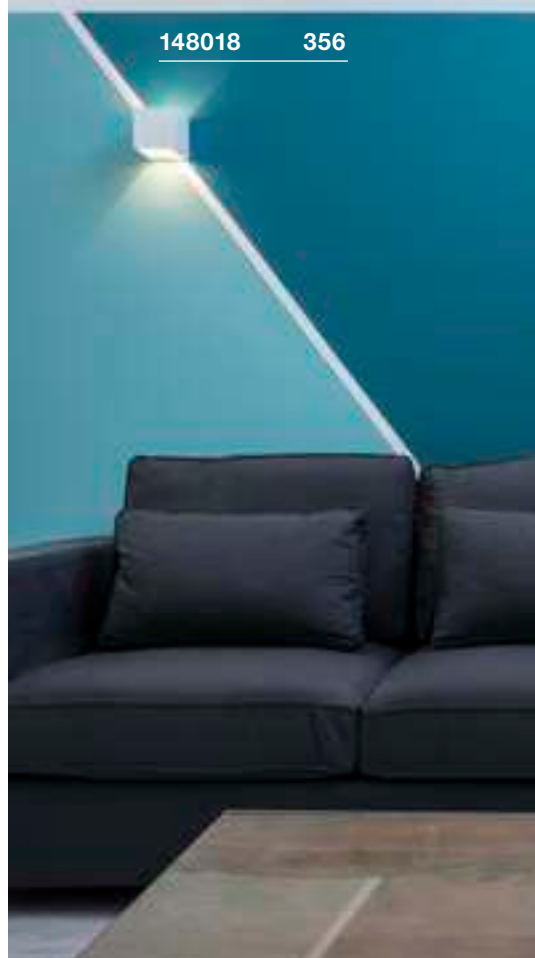

1002238 357





PLASTRA
WL, rettangolare, QT-DE12

PLASTRA
WL, E14

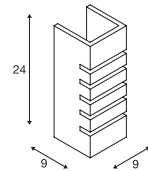
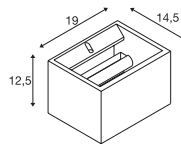
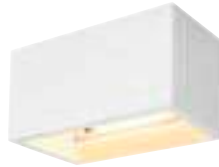

220-240V ~50/60Hz
Materiale: gesso/acciaio

220-240V ~50/60Hz
Materiale: gesso/acciaio

- Personalizzabile con pitture murali o tappezzeria

- Personalizzabile con pitture murali o tappezzeria



Attacco: 1xR7s 118mm

Attacco: 1xE14

Versione	Articolo	EUR
<input type="radio"/> bianco	1002238	79,00

Versione	Articolo	EUR
<input type="radio"/> bianco	148010	52,00



LED R7s | 15W | 330°
3000K | 400lm | Classe=E
15kWh/1000h



Articolo: 1005288 | 28,50 EUR



C35 | 4,2W | 320°
2700K | 350lm | Classe=G
5kWh/1000h



Articolo: 1005285 | 8,50 EUR



148010 357

1004732 359



148091 359





PLASTRA
WL, semicircolare

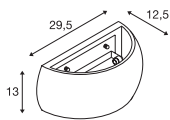

220-240V ~50/60Hz
Materiale: gesso/acciaio

- Personalizzabile con pitture murali o tappezzeria



Attacco: 1xR7s 118mm Ø max.: 2 cm L: 11,8 cm

Versione	Articolo	EUR
<input type="radio"/> bianco	1004732	73,00

PLASTRA
WL, Shield rund

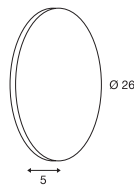

100-240V ~50/60Hz | 12V
Potenza assorbita: 6,5W
Materiale: gesso/acciaio

- Personalizzabile con pitture murali o tappezzeria



Down 375lm | 3000K

Versione	Articolo	EUR
<input type="radio"/> bianco	148091	168,00

PLASTRA
WL, quadrato

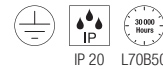
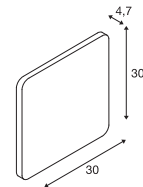

100-240V ~50/60Hz | 12V
Potenza assorbita: 10,5W
Materiale: gesso/acciaio

- Personalizzabile con pitture murali o tappezzeria



Down 650lm | 3000K

Versione	Articolo	EUR
<input type="radio"/> bianco	148019	216,00



LED R7s | 15W | 330°
3000K | 400lm | Classe=E
15kWh/1000h



Articolo: 1005288 | 28,50 EUR



148060 360

PLASTRA WL, QPAR51

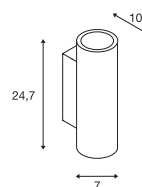

148013 361



IP 20

220-240V ~50/60Hz
Materiale: gesso/acciaio

- Personalizzabile con pitture murali o tappezzeria

SOCKET
INSIDE

<35
W

Attacco: 2xGU10

Versione	Articolo	EUR
○ bianco	148060	67,00



LED GU10 51mm | 6W | 36°
2200-2700K | 360lm | Classe=G
6kWh/1000h



Articolo: 1005273 | 9,99 EUR



PLASTRA 101
WL, E14

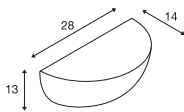

220-240V ~50/60Hz
Materiale: gesso/acciaio

- Personalizzabile con pitture murali o tappezzeria



Attacco: 1xE14 Ø max.: 4,5 cm L: 11 cm

Versione	Articolo	EUR
○ bianco	148013	54,00



C35 | 4,2W | 320°
2700K | 350lm | Classe=G
5kWh/1000h



Articolo: **1005285** | **8,50 EUR**

PLASTRA
WL, Curve, QT-DE12

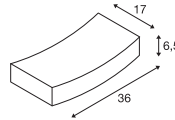

220-240V ~50/60Hz
Materiale: gesso/acciaio

- Personalizzabile con pitture murali o tappezzeria



Attacco: 1xR7s 78mm

Versione	Articolo	EUR
○ bianco	148012	73,00



LED R7s | 9W | 330°
3000K | 1050lm | Classe=E
9kWh/1000h



Articolo: **1005287** | **24,00 EUR**

PLASTRA 104
WL, QT14

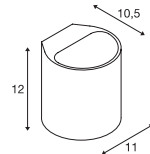

220-240V ~50/60Hz
Materiale: gesso/acciaio

- Personalizzabile con pitture murali o tappezzeria



Attacco: 1xGU9

Versione	Articolo	EUR
○ bianco	148016	54,00



LED G9 | 3,6W | 300°
3000K | 400lm | Classe=E
4kWh/1000h



Articolo: **1005286** | **9,99 EUR**

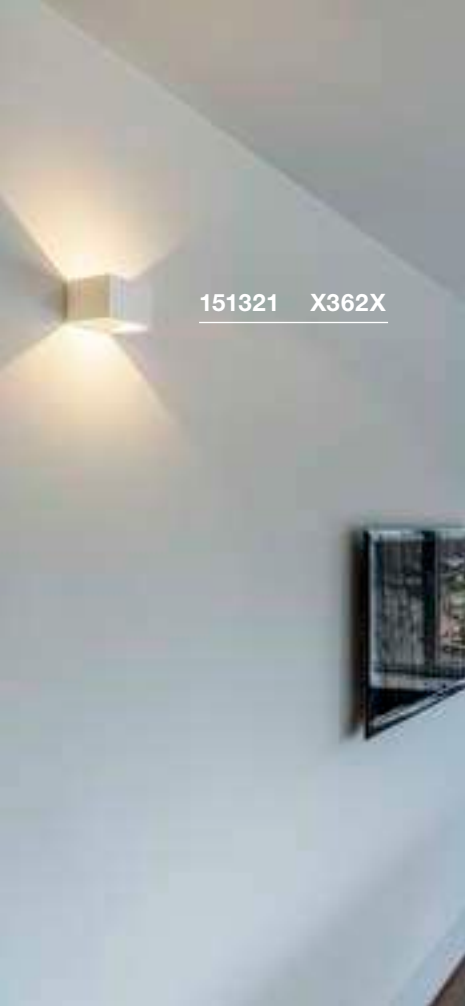

151321 X362X



1000638 362

LOGS IN WL

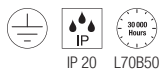
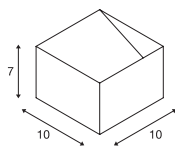

100-240V ~50/60Hz | 500mA
Potenza assorbita: 6W
Materiale: alluminio



Down 300lm | 470lm | 3000K

Versione	Articolo	EUR
●● nero/oro 300lm	151320	118,00
○ bianco 470lm	151321	118,00

LOGS IN WL, PHASE

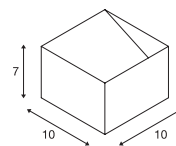

220-240V ~50/60Hz | 250mA
Potenza assorbita: 11W
Materiale: alluminio



Down 430-690lm | 2000-3000K

Versione	Articolo	EUR
●● nero/oro 430lm	1000638	159,00
○ bianco 690lm	1000639	159,00
●○ alluminio/bianco 690lm	1000640	159,00



1002843 363

LOGS IN L
WL, PHASE

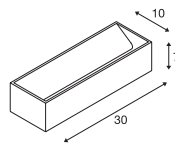

220-240V ~50/60Hz | 500mA
Potenza assorbita: 18W
Materiale: alluminio



Down 1100lm | 1600lm | 3000K

Versione	Articolo	EUR
●● nero/oro 1100lm	1002842	205,00
○ bianco 1600lm	1002844	205,00
●○ alluminio/bianco 1600lm	1002843	205,00

LOGS IN L
WL, PHASE

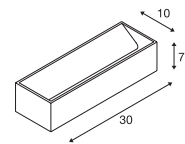

220-240V ~50/60Hz | 500mA
Potenza assorbita: 21W
Materiale: alluminio



Down 1000lm | 2000-3000K

Versione	Articolo	EUR
●● nero/oro 1000lm	1002928	275,00
○ bianco 1390lm	1002929	275,00



1002928 363



1003467 364



1003468 364

QUAD FRAME 14 WL

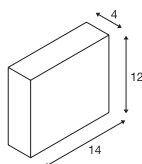
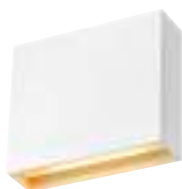

100-240V ~50/60Hz | 350mA
Potenza assorbita: 4,4W
Materiale: alluminio



Down 165lm | 2700K | 175lm | 3000K

Versione	Articolo	EUR
○ bianco	1003467	99,00

QUAD FRAME 19 WL

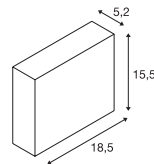

220-240V ~50/60Hz | 500mA
Potenza assorbita: 11W
Materiale: alluminio



Down 580lm | 2700K | 640lm | 3000K

Versione	Articolo	EUR
○ bianco	1003468	119,00

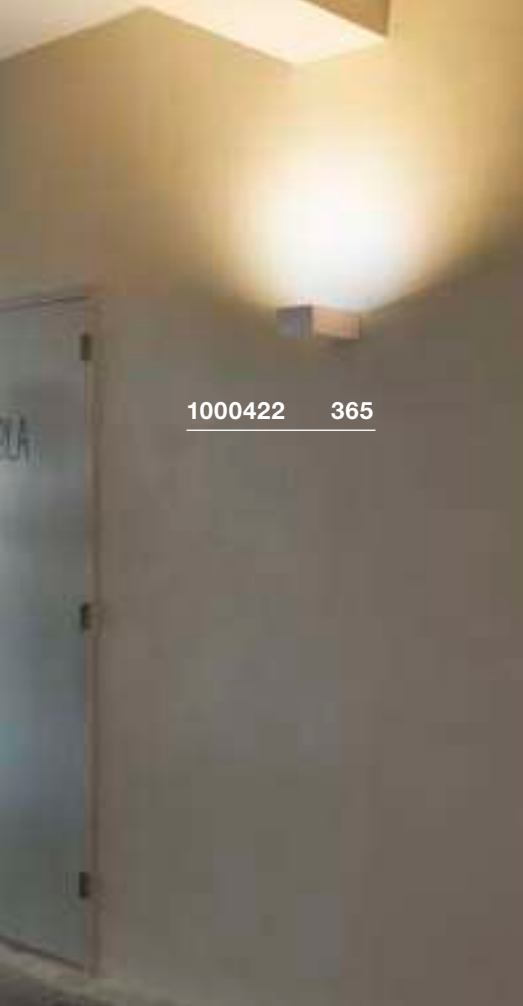

1000422 365

SHELL 15
WL, PHASE

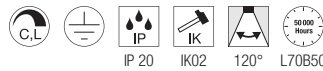
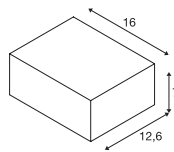

220-240V ~50/60Hz | 350mA
Potenza assorbita: 15W
Materiale: alluminio/acrilico



Down 1400lm | 3000K

Versione	Articolo	EUR
<input type="radio"/> bianco	1000422	252,00

SHELL 30
WL, PHASE

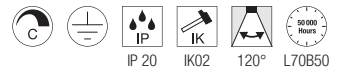
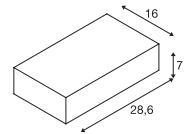

220-240V ~50/60Hz | 700mA
Potenza assorbita: 54W
Materiale: alluminio/acrilico



Down 5600lm | 3000K

Versione	Articolo	EUR
<input type="radio"/> bianco	1000423	378,00



1000423 365



151275 366

ASSO 300 WL, PHASE

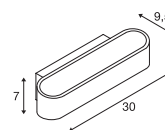

151410 366



IP 20 L70B50

220-240V ~50/60Hz | 500mA

Potenza assorbita: 12W

Materiale: alluminio/acciaio



CRI
80

Down

975lm | 3000K

Versione	Articolo	EUR
○ bianco	151271	215,00
● alluminio/bianco	151275	226,00



ASSO 300 WL, PHASE

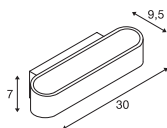
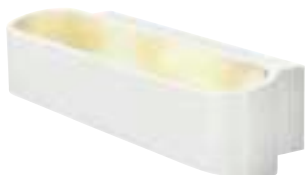

220-240V ~50/60Hz | 500mA
Potenza assorbita: 21W
Materiale: alluminio/acciaio



Down 1340lm | 2000-3000K

Versione	Articolo	EUR
○ bianco	1000634	252,00

OSSA 180 WL, QT-DE12

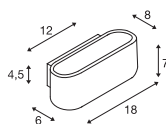

220-240V ~50/60Hz
Materiale: alluminio/acciaio



Attacco: 1xR7s 78mm

Versione	Articolo	EUR
● nero	151450	96,00
○ bianco	151451	96,00
● alluminio	151456	102,00



LED R7s | 9W | 330°
3000K | 1050lm | Classe=E
9kWh/1000h



Articolo: 1005287 | 24,00 EUR

OSSA 300 WL, QT-DE12

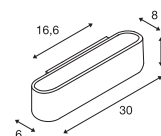

220-240V ~50/60Hz
Materiale: alluminio/acciaio



Attacco: 1xR7s 118mm

Versione	Articolo	EUR
● nero	151410	117,00
○ bianco	151411	117,00



LED R7s | 15W | 330°
3000K | 400lm | Classe=E
15kWh/1000h



Articolo: 1005288 | 28,50 EUR

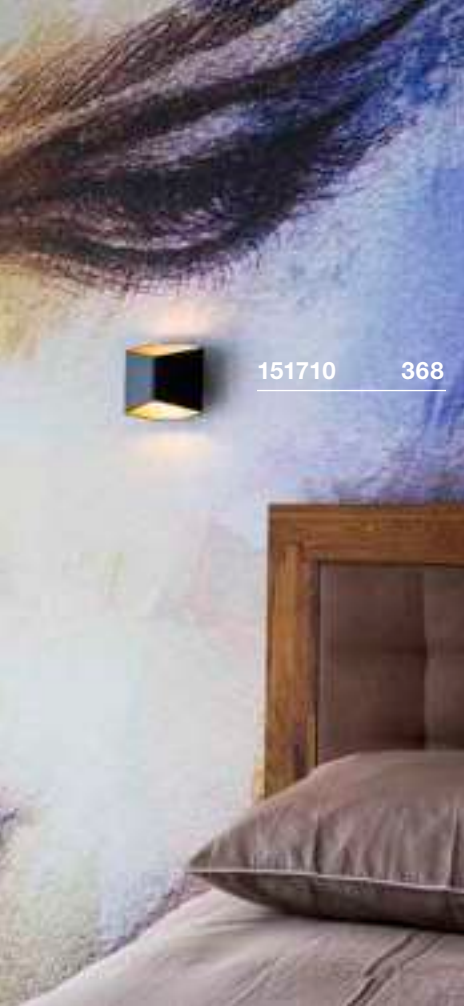

CARISO WL, PHASE

CARISO WL, PHASE

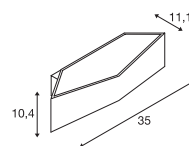
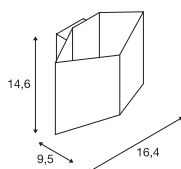

IP 20 L70B50

220-240V ~50/60Hz | 500mA
Potenza assorbita: 9,2W
Materiale: alluminio/acciaio



IP 20 L70B50

220-240V ~50/60Hz | 500mA
Potenza assorbita: 21W
Materiale: alluminio/acciaio



Down 250lm | 2700K
560lm | 3000K



Down 580lm | 1700-2700K
1030lm | 2000-3000K

151740 368

Versione	Articolo	EUR
●● nero/oro 250lm 2700K	151710	169,00
○ bianco 560lm 3000K	151711	165,00

Versione	Articolo	EUR
●● nero/oro 580lm 1700-2700K	151740	289,00
○ bianco 1030lm 2000-3000K	151741	279,00

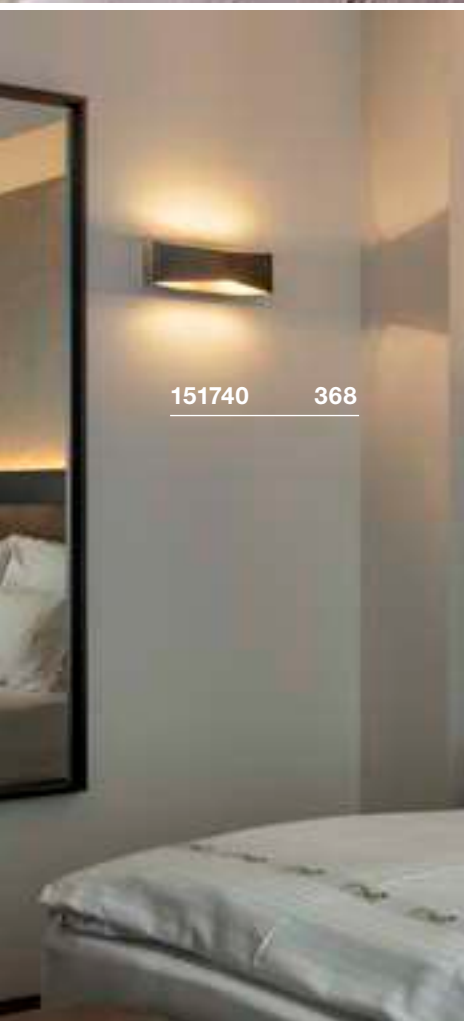



CHROMBO WL, PHASE



1003317 369

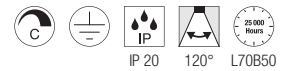

220-240V ~50/60Hz | 350mA
Potenza assorbita: 11W
Materiale: acciaio/vetro



Down

700lm | 3000K

Versione	Articolo	EUR
○ bianco	1003316	171,00
● grigio	1003317	171,00

DIRETO 60
WL, PHASE

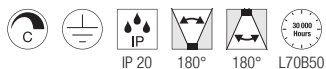
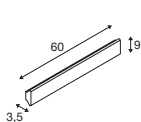

220-240V ~50/60Hz | 500mA
Potenza assorbita: 14W
Materiale: alluminio



Up 590lm | 2700K | 625lm | 3000K
Down

Versione	Articolo	EUR
● nero	1004740	199,00
○ bianco	1004741	199,00

DIRETO 90
WL, PHASE

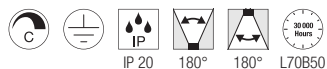
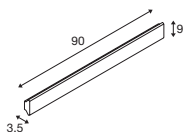

220-240V ~50/60Hz | 500mA
Potenza assorbita: 20W
Materiale: alluminio



Up 840lm | 2700K | 880lm | 3000K
Down

Versione	Articolo	EUR
● nero	1004742	239,00
○ bianco	1004743	239,00





ARLINA 60 WL

ARLINA 130 WL

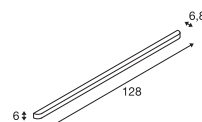
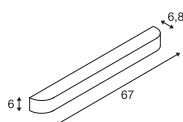

220-240V ~50/60Hz | 500mA
Potenza assorbita: 23W
Materiale: alluminio/vetro

220-240V ~50/60Hz | 700mA
Potenza assorbita: 28W
Materiale: alluminio/vetro



Down 1550lm | 3000K

Down 2400lm | 3000K

Versione	Articolo	EUR
● alluminio	1002239	253,00

Versione	Articolo	EUR
● alluminio	1002240	325,00



147529 373



151591 373



ANDREAS
WL, QT-DE12

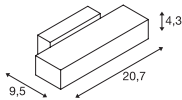

220-240V ~50/60Hz
Materiale: alluminio



Attacco: 1xR7s 118mm

Versione	Articolo	EUR
● nero	1002927	108,00
○ bianco	1002925	108,00



LED R7s | 15W | 330°
3000K | 400lm | Classe=E
15kWh/1000h



Articolo: 1005288 | 28,50 EUR

DENA 30
WL, E14

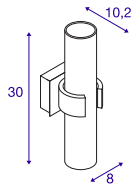

220-240V ~50/60Hz
Materiale: alluminio



Attacco: 2xE14 max. Ø: 5,1 cm L: 9,6 cm

Versione	Articolo	EUR
● alluminio	147529	103,00



C35 | 4,2W | 320°
2700K | 350lm | Classe=G
5kWh/1000h



Articolo: 1005285 | 8,50 EUR

BASKET
WL, E27

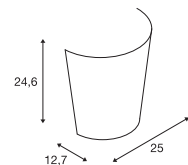

220-240V ~50/60Hz
Materiale: vetro



Attacco: 1xE27 Ø max.: 5,2 cm L: 15,2 cm

Versione	Articolo	EUR
○ bianco	151591	97,00



LED E27 | 8W | 240°
3000K | 880lm | Classe=E
8kWh/1000h



Articolo: 1005289 | 10,25 EUR

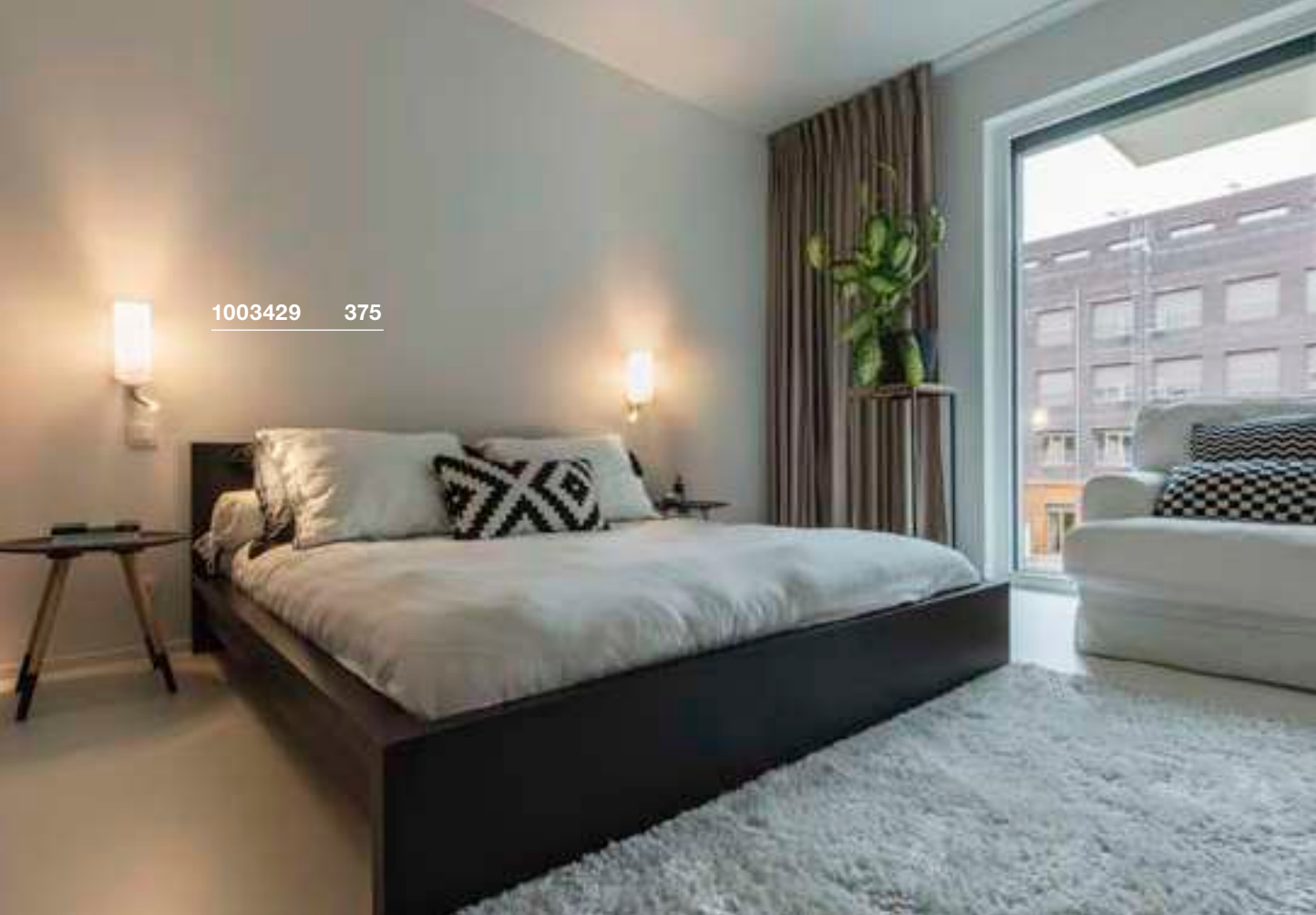

1003429 375



155752 375



QUADRASS WL, E27

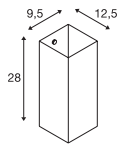

220-240V ~50/60Hz
Materiale: acciaio/vetro



Attacco: 1xE27 Ø max.: 6,5 cm L: 18 cm

Versione	Articolo	EUR
● nero	1003430	140,00
○ bianco	1003431	140,00



LED E27 | 13,2W | 220°
2700K | 1300lm | Classe=F
13kWh/1000h



Articolo: 1005302 | 12,25 EUR

QUADRASS SPOT WL, E27

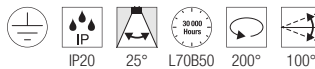
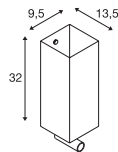

100-240V ~50/60Hz | 700mA
Potenza assorbita: 2W
Materiale: acciaio/vetro

- Interruttore sull'alloggiamento lampada
- Sorgenti luminose gestibili separatamente



Down 200lm | 3000K



Attacco: 1xE27 Ø max.: 6,5 cm L: 18 cm

Versione	Articolo	EUR
● nero	1003428	211,00
○ bianco	1003429	211,00



A60 | 7,5W | 320°
2700K | 800lm | Classe=F
8kWh/1000h



Articolo: 1005303 | 9,60 EUR

LISENNE WL, E27

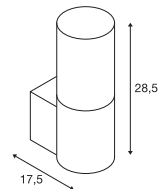

220-240V ~50/60Hz
Materiale: basalto/vetro



Attacco: 1xE27 Ø max.: 5,9 cm L: 15 cm

Versione	Articolo	EUR
● grigio/fumè	155752	241,00



LED E27 | 8W | 240°
3000K | 880lm | Classe=E
8kWh/1000h



Articolo: 1005289 | 10,25 EUR

FITU
Supporto da parete

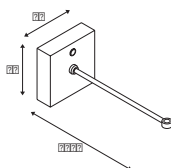

Materiale: acciaio

- Sospensioni abbinabili a pag. 295

Versione	Articolo	EUR
● nero	1004682	64,00

FITU CUBE
WL, E27

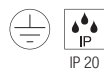
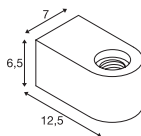

220-240V ~50/60Hz
Materiale: acciaio



Attacco: 1xE27 Ø max.: 12,5 cm

Versione	Articolo	EUR
● nero	1004738	80,00
○ bianco	1004739	80,00



A60 | 7,5W | 180°
2700K | 720lm | Classe=F
8kWh/1000h



Articolo: 1005305 | 19,00 EUR

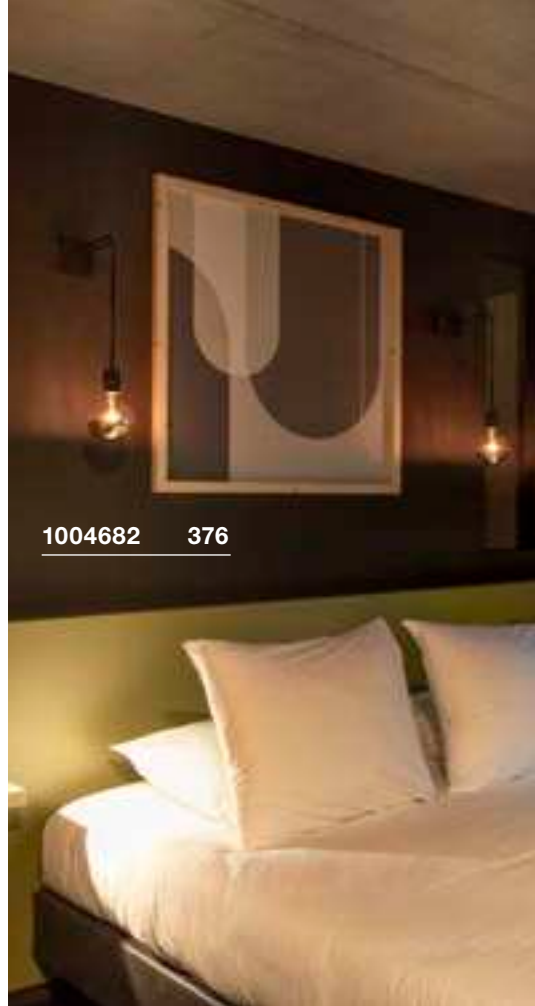

1004682 376

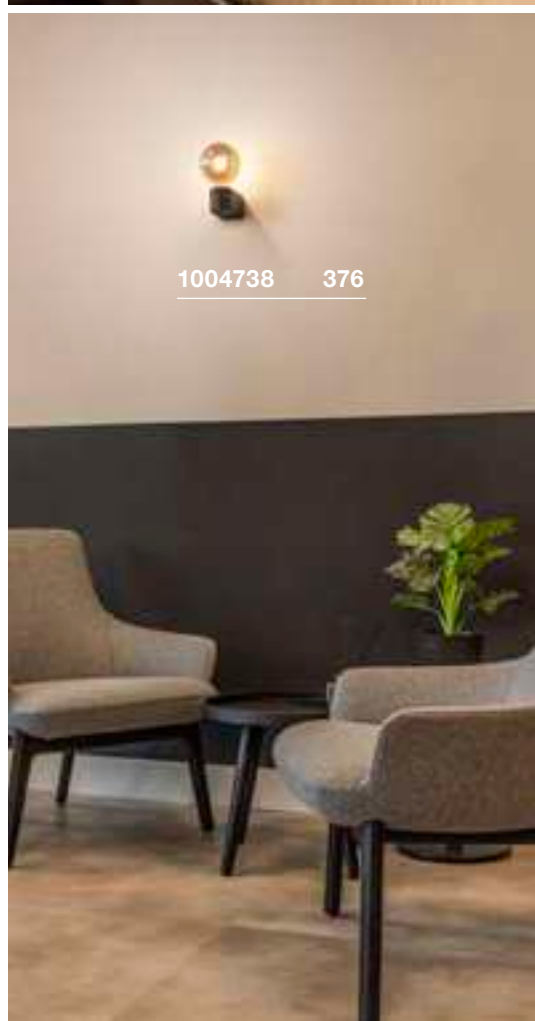

1004738 376



1000327 377

THEO UP/DOWN
WL, QPAR51

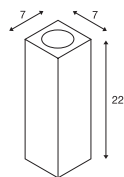

IP 20

220-240V ~50/60Hz
Materiale: alluminio



Attacco: 2xGU10

Versione	Articolo	EUR
● antracite	1000330	115,00
○ bianco	1000327	115,00
● alluminio	1000329	122,00



LED GU10 51mm | 6W | 38°
2700K | 450lm | Classe=F
6kWh/1000h



Articolo: 1005077 | 7,50 EUR

SOLID CUBE
WL, QT14

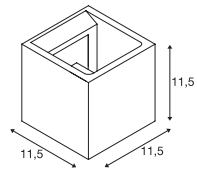

IP 20

220-240V ~50/60Hz
Materiale: calcestruzzo



Attacco: 1xGU9

Versione	Articolo	EUR
● grigio	1000910	97,00
● nero	1000911	97,00



LED G9 | 3,6W | 300°
3000K | 400lm | Classe=E
4kWh/1000h



Articolo: 1005286 | 9,99 EUR



1000910 377

151803 379





ENOLA B
WL, QPAR51

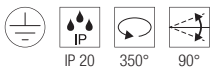
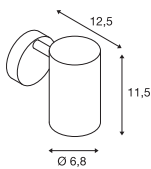

220-240V ~50/60Hz
Materiale: alluminio/acciaio

- Interruttore sull'alloggiamento lampada



Attacco: 1xGU10 max. L: 6 cm

Versione	Articolo	EUR
● nero	1000729	81,00
○ bianco	1000730	81,00



LED GU10 51mm | 6W | 38°
2700K | 450lm | Classe=F
6kWh/1000h



Articolo: 1005077 | 7,50 EUR



Articolo	Articolo	EUR
Anello decorativo		
● nero	151840	8,95

ENOLA B
WL, QPAR51

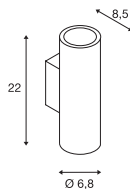

220-240V ~50/60Hz
Materiale: alluminio/acciaio



Attacco: 2xGU10 max. L: 8,5 cm

Versione	Articolo	EUR
● nero	151800	94,00
○ bianco	151801	94,00
● oro	151803	104,00



LED GU10 51mm | 6W | 38°
2700K | 450lm | Classe=F
6kWh/1000h



Articolo: 1005077 | 7,50 EUR



Articolo	Articolo	EUR
Anello decorativo		
● nero	151840	8,95

ASTINA UP/DOWN
WL, QPAR51

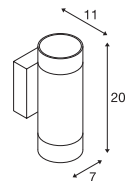

220-240V ~50/60Hz
Materiale: alluminio/acciaio



Attacco: 2xGU10

Versione	Articolo	EUR
● nero	1002933	112,00
○ bianco	1002931	112,00



LED GU10 51mm | 6W | 36°
2200-2700K | 360lm | Classe=G
6kWh/1000h



Articolo: 1005273 | 9,99 EUR

FENDA
WL, Base, E27

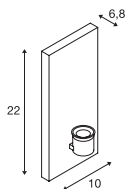

FENDA
Semi-diffusore



La: 23 cm H: 30 cm P: 12 cm
Materiale: tessuto/acciaio

Versione	Articolo	EUR
● nero	1001273	38,50
● nero/rame	1001274	44,75
○ bianco	1001275	38,50
● beige	1001276	38,50



220-240V ~50/60Hz
Materiale: acciaio/plastica



Attacco: 1xE27 max. Ø: 5,1 cm L: 20 cm

Versione	Articolo	EUR
○ bianco	1001272	52,00



LED E27 | 8W | 240°
3000K | 880lm | Classe=E
8kWh/1000h



Articolo: 1005289 | 10,25 EUR



1001272 + 1001273 380



149452 381



KENKUA SPOT WL, E27

COUPA FLEX WL

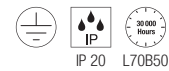
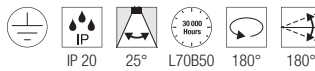
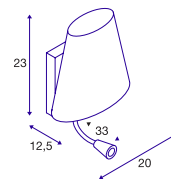
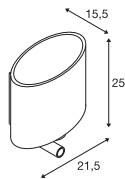

100-240V ~50/60Hz | 700mA
Potenza assorbita: 2W
Materiale: acciaio/vetro

220-240V ~50/60Hz | 700mA
Potenza assorbita: 3,2W
Materiale: acciaio/vetro

- Sorgenti luminose gestibili separatamente

- Sorgenti luminose gestibili separatamente



Down 200lm | 3000K



Down 140lm | 3000K



Attacco: 1xE27 Ø max.: 6,5 cm | L: 12 cm



Attacco: 1xGU9 max. L: 9 cm

Versione	Articolo	EUR
● cromo	1002855	206,00

Versione	Articolo	EUR
● cromo / opalescente	149452	206,00



A60 | 7,5W | 320°
2700K | 800lm | Classe=F
8kWh/1000h



Articolo: 1005303 | 9,60 EUR



LED G9 | 3,6W | 300°
3000K | 400lm | Classe=E
4kWh/1000h



Articolo: 1005286 | 9,99 EUR



KARPO MAGN
CW, single, PHASE

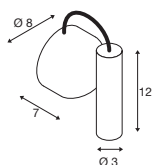

220-240V ~50/60Hz | 500mA
Potenza assorbita: 6,2W
Materiale: acciaio/alluminio

- Grazie al supporto magnetico, lo spot può essere orientato liberamente



Down 350lm | 430lm | 3000K

Versione	Articolo	EUR
● nero		
350lm	1004706	197,00
○ bianco		
430lm	1004707	197,00

KARPO GOOSE
WL

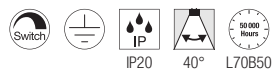
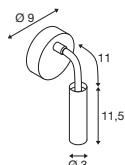

220-240V ~50/60Hz | 12V
Potenza assorbita: 5,8W
Materiale: alluminio/acciaio

- L'apparecchio è dimmerabile tramite pulsante sul vano ottico



Down 380lm | 420lm | 3000K

Versione	Articolo	EUR
● nero		
380lm	1006162	179,00
○ bianco		
420lm	1006161	179,00



1002140 383

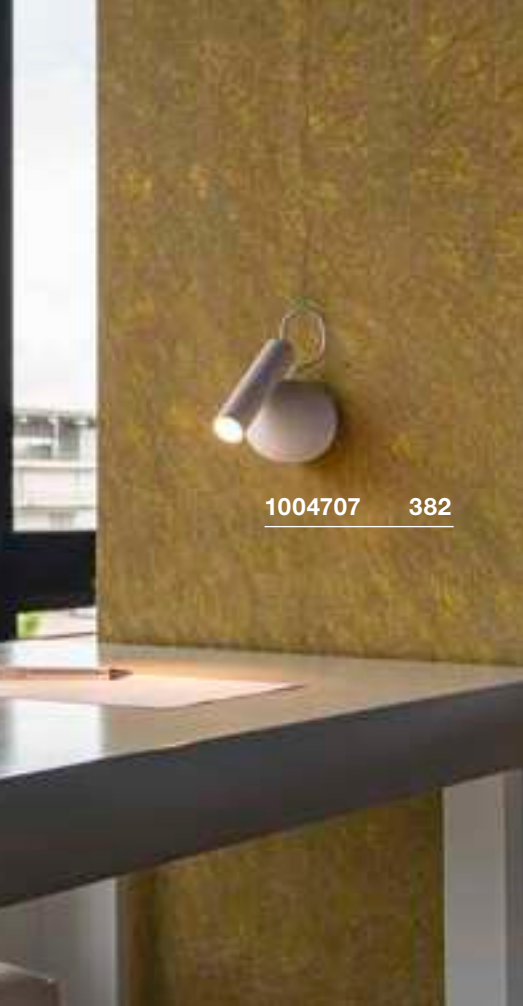

1004707 382

KARPO 30 WL, single

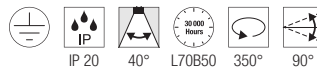
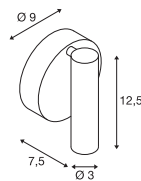

100-240V ~50/60Hz | 500mA
Potenza assorbita: 6W
Materiale: alluminio/acciaio

- Interruttore sull'alloggiamento lampada



Down 370lm | 400lm 3000K

Versione	Articolo	EUR
● nero		
370lm	152340	125,00
○ bianco		
400lm	152341	125,00

KARPO WL

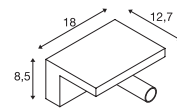

220-240V ~50/60Hz | 500mA
Potenza assorbita: 6,8W
Materiale: alluminio

- 2 porte USB 1,5A max
- 3 livelli di dimmerabilità tramite pulsante sulla base



Down 390lm | 3000K

Versione	Articolo	EUR
○ bianco	1002140	242,00





1003457 384

SOMNILA SPOT WL, sinistra

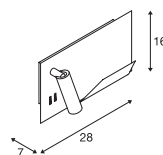

1003459 385



100-240V ~50/60Hz | 12V
Potenza assorbita: 15W
Materiale: alluminio/acciaio

- 1 porta USB
- Le sorgenti luminose sono gestibili separatamente



Down

120lm | 3000K

Versione	Articolo	EUR
● nero 490lm	1003455	232,00
○ bianco 770lm	1003457	232,00



SOMNILA SPOT WL, destra

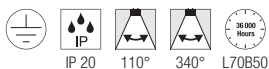
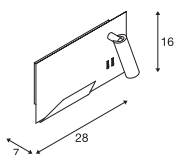

100-240V ~50/60Hz | 12V
Potenza assorbita: 15W
Materiale: alluminio/acciaio

- 1 porta USB
- Le sorgenti luminose sono gestibili separatamente



Down 120lm | 3000K

SOMNILA FLEX WL, sinistra

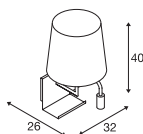

100-240V ~50/60Hz | 12V
Materiale: alluminio

- Le sorgenti luminose sono gestibili separatamente.



Down 120lm | 3000K



Attacco: 1xE27 max. L: 18 cm

SOMNILA FLEX WL, destra

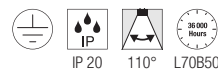
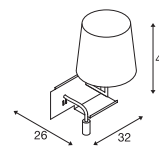

100-240V ~50/60Hz | 12V
Materiale: alluminio

- Le sorgenti luminose sono gestibili separatamente.



Down 120lm | 3000K



Attacco: 1xE27 max. L: 18 cm

Versione	Articolo	EUR
● nero 490lm	1003456	232,00
○ bianco 770lm	1003458	232,00

Versione	Articolo	EUR
○ bianco	1003459	242,00

Versione	Articolo	EUR
○ bianco	1003460	242,00





DIO FLEX PLATE WL QPAR51

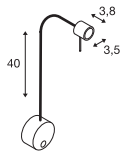

220-240V ~50/60Hz
Materiale: alluminio

- Interruttore sulla base lampada
- Anello decorativo non compreso
- Base: Ø: 8,8 cm, H: 3,2 cm



Attacco: 1xGU10

Versione	Articolo	EUR
● nero	1002608	57,00
○ bianco	1002607	57,00
● cromo	146692	66,00



LED GU10 51mm | 6W | 38°
2700K | 450lm | Classe=F
6kWh/1000h



Articolo: 1005077 | 7,50 EUR

DIO FLEX PLATE WL

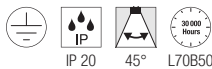
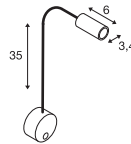

100-240V ~50/60Hz | 350mA
Potenza assorbita: 1,9W
Materiale: alluminio/vetro

- Interruttore sulla base lampada
- Base: Ø: 9 cm, H: 4,4 cm



Down

100lm

2700K
3000K
4000K

Versione	Articolo	EUR
● nero 2700K	1002430	100,00
○ bianco 2700K	1002117	100,00
● nero 3000K	1002431	100,00
○ bianco 3000K	1002118	100,00
● nero 4000K	1002432	100,00
○ bianco 4000K	1002119	100,00

DIO FLEX PLATE WL

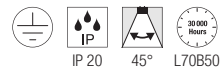
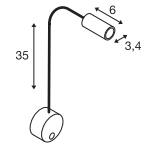

100-240V ~50/60Hz | 350mA
Potenza assorbita: 1,9W
Materiale: alluminio/vetro

- Interruttore sulla base lampada
- Base: Ø: 9 cm, H: 4,4 cm



Down

100lm

2700K
3000K

Versione	Articolo	EUR
● cromo 2700K	1002116	106,00
● cromo 3000K	146682	106,00

PHELIA
WL, QPAR51

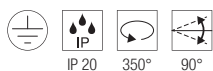
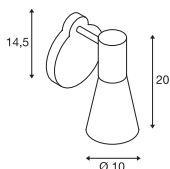

220-240V ~50/60Hz
Materiale: alluminio/acciaio

- Interruttore sul vano ottico



Attacco: 1xGU10 max. Ø: 5,1 cm | L: 10,5 cm

Versione	Articolo	EUR
● nero	148540	131,00



LED GU10 51mm | 6W | 38°
2700K | 450lm | Classe=F
6kWh/1000h



Articolo: 1005077 | 7,50 EUR

MERADO FLOOD
WL, PHASE

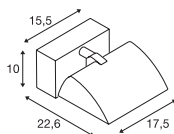

220-240V ~50/60Hz | 1000mA
Potenza assorbita: 40W
Materiale: alluminio



Down 3000lm | 3000K
3200lm | 4000K

Versione	Articolo	EUR
○ bianco 3000lm 3000K	1001468	247,00
○ bianco 3200lm 4000K	1001472	247,00



148540 388



1001468 388



1002860 389



DISPLAY ADL 50
QPAR51

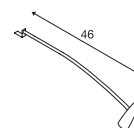

220-240V ~50/60Hz
Materiale: alluminio/ottone

- Cavo con terminale aperto
- Scatola allacciamenti inclusa

SOCKET INSIDE <50 W

Attacco: 1xGU10

Versione	Articolo	EUR
○ bianco	1002860	48,25
● cromo	146332	62,00



LED GU10 51mm | 6W | 36°
2200-2700K | 360lm | Classe=G



Articolo: 1005273 | 9,99 EUR

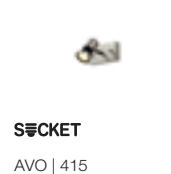
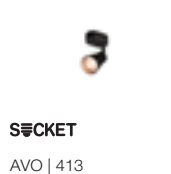
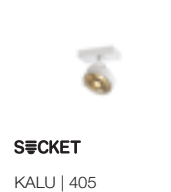
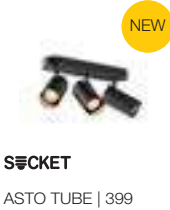
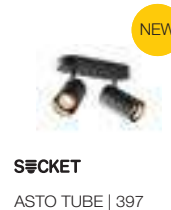
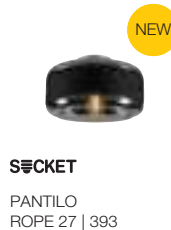
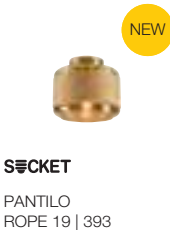



SCKET
ASTO | 415



SCKET
ASTO | 415



SCKET
ASTO | 415



LEDS
SENSER 12 | 417



LEDS
SENSER 18 | 417



LEDS
SENSER 24 | 417



LEDS
SENSER 12 | 419



LEDS
SENSER 18 | 419



LEDS
SENSER 24 | 419



LEDS
SIMA | 420



LEDS
SIMA | 420



LEDS
SIMA | 421



LEDS
SIMA | 421



LEDS
LIPSY® 30 | 423



LEDS
LIPSY® 40 | 423



LEDS
LIPSY® 50 | 423



LEDS
LIPSY® 30 | 425



LEDS
LIPSY® 40 | 425



LEDS
LIPSY® 50 | 425



LEDS
LIPSY® 40 | 426



LEDS
LIPSY® 50 | 426



SCKET
MELAN | 427



SCKET
GLASSA | 427



LEDS
BATTEN 60 | 429



LEDS
BATTEN 120 | 429



LEDS
LONG GRILL | 430



LEDS
SIGHT 60 | 431



LEDS
SIGHT 115 | 431



LEDS
BENA 120 | 433



LEDS
BENA 150 | 433



1007591 393





PANTILO ROPE 19 CW, E27

PANTILO ROPE 27 CW, E27

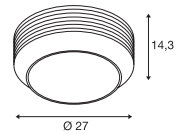
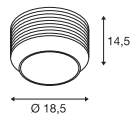
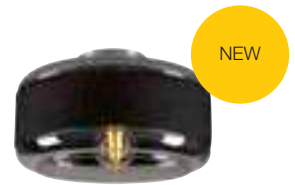

200-240V ~50/60Hz
Materiale: acciaio/vetro/canapa

200-240V ~50/60Hz
Materiale: acciaio/vetro/canapa



Attacco: 1xE27 Ø max.: 10 cm L: 11 cm

Attacco: 1xE27 Ø max.: 15 cm L: 11 cm

Versione	Articolo	EUR
● ambra/oro	1007592	159,00
● antracite/argento	1007593	159,00

Versione	Articolo	EUR
● ambra/oro	1007591	199,00
● antracite/argento	1007590	199,00



A60 | 7,5W | 180°
2700K | 720lm | Classe=F
8kWh/1000h



A60 | 7,5W | 180°
2700K | 720lm | Classe=F
8kWh/1000h



Articolo: 1005305 | 19,00 EUR

Articolo: 1005305 | 19,00 EUR

1006439 395





CYFT CW



NEW

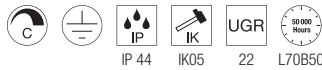
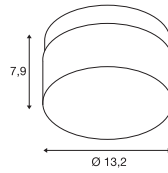

220-240V ~50/60Hz | 500mA
Potenza assorbita: 6,5W
Materiale: alluminio



330lm | 2700K | 350lm | 3000K | 380lm | 4000K

Versione	Articolo	EUR
● nero	1007608	199,00

ASTO TUBE CL, single, GU10



NEW

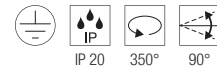
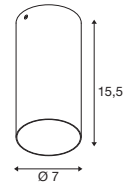

220-240V ~50/60Hz
Materiale: alluminio



Attacco: 1xGU10

Versione	Articolo	EUR
● nero	1006439	50,00
○ bianco	1006440	50,00

CYFT Anello decorativo



NEW

H: 2,45 cm
Ø: 13,10 cm
Materiale: acciaio

Versione	Articolo	EUR
○ bianco	1007611	18,00
● messing	1007610	29,90
● cromo	1007609	25,00

ASTO TUBE Anello decorativo



NEW

H: 3,95 cm
Ø: 6,75 cm
Materiale: policarbonato (PC)

Versione	Articolo	EUR
● nero-cromo	1007190	4,00
● oro	1006450	4,00
● cromo	1006449	4,00
● rame	1006451	4,00

1006423 397



1006428 397





ASTO TUBE

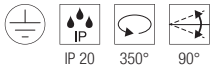

220-240V ~50/60Hz
Materiale: alluminio



Attacco: 2xGU10



LED GU10 | 6W | 38°
2700K | 450lm | Classe=F
6kWh/1000h



Articolo: 1005076 | 7,50 EUR

ASTO TUBE CW, single, GU10

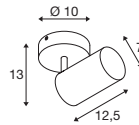

ASTO TUBE CW, double, GU10

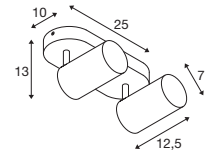

Versione	Articolo	EUR
● nero	1006423	50,00
○ bianco	1006424	50,00

Versione	Articolo	EUR
● nero	1006425	95,00
○ bianco	1006426	95,00

ASTO TUBE Anello decorativo



H: 3,95 cm
Ø: 6,75 cm
Materiale: policarbonato (PC)

ASTO TUBE CW, triple, GU10

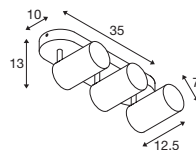

ASTO TUBE CW, quadruple, GU10

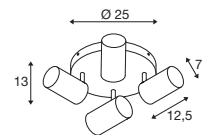

Versione	Articolo	EUR
● nero-cromo	1007190	4,00
● oro	1006450	4,00
● cromo	1006449	4,00
● rame	1006451	4,00

Versione	Articolo	EUR
● nero	1006427	135,00
○ bianco	1006428	135,00

Versione	Articolo	EUR
● nero	1006429	165,00
○ bianco	1006430	165,00



1004664 399

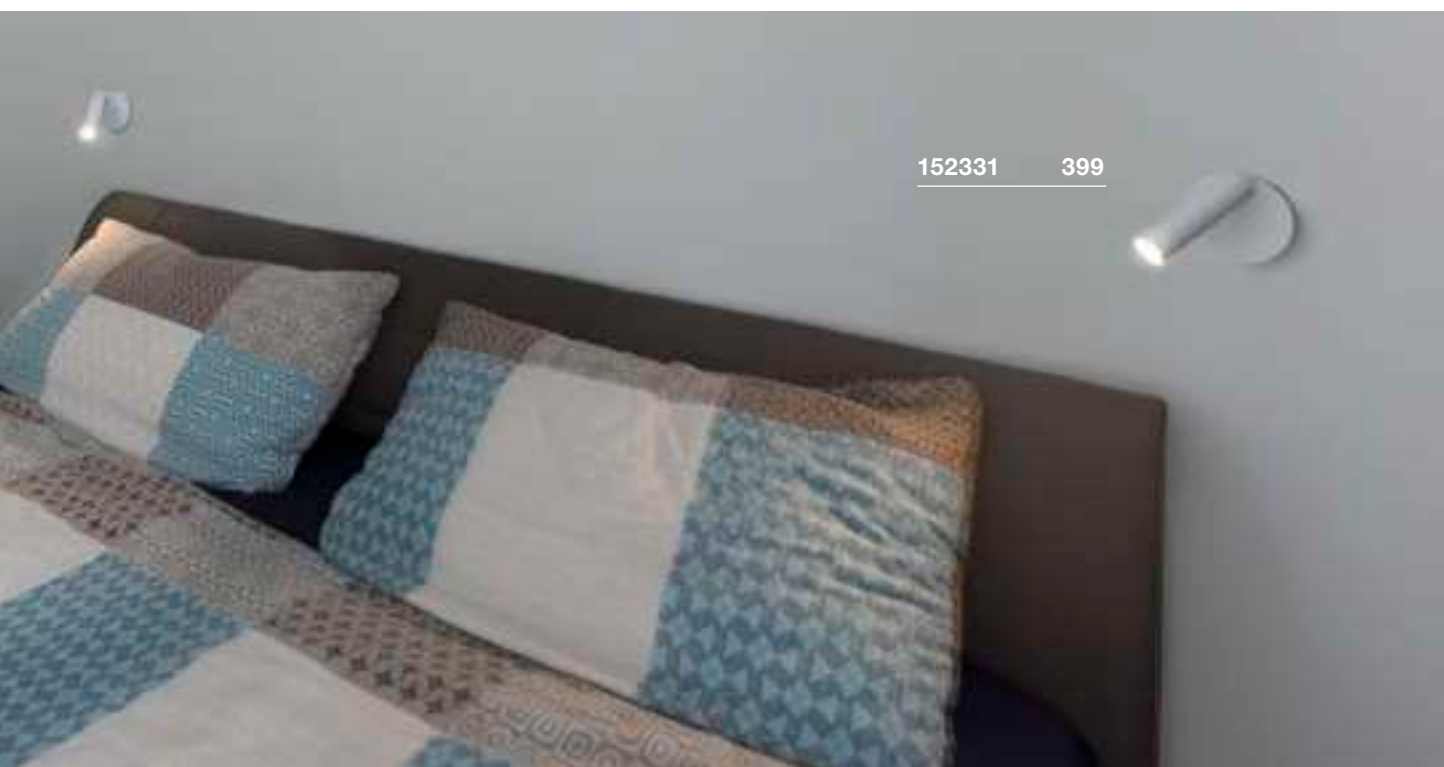

152331 399



OCULUS CW, PHASE

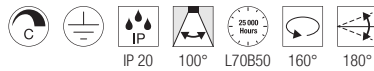
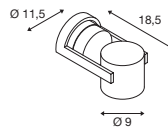

220-240V ~50/60Hz | 250mA
Potenza assorbita: 11W
Materiale: alluminio/vetro

- Inclusa lente smerigliata aggiuntiva



Down 36lm | 2000K - 780lm | 3000K

Versione	Articolo	EUR
● nero	1004664	255,00
○ bianco	1004665	255,00

KARPO 30 CW, single

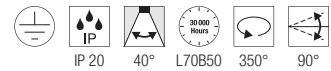
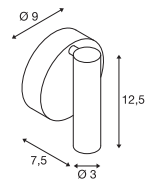

220-240V ~50/60Hz | 500mA
Potenza assorbita: 9,3W
Materiale: alluminio/acciaio



Down 560lm | 3000K
680lm

Versione	Articolo	EUR
● nero	560lm	129,00
○ bianco	680lm	129,00



1002974 401





NOBLO®

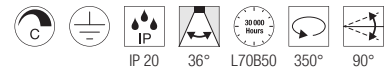

220-240V ~50/60Hz | 350mA
 Potenza assorbita: 8W
 Materiale: alluminio



Down	620lm	2700K
	1240lm	
	1860lm	

NOBLO® CW, single, PHASE

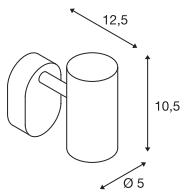

NOBLO® CW, double, PHASE

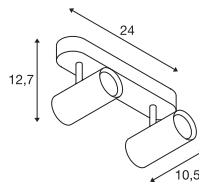

NOBLO® CW, triple, PHASE

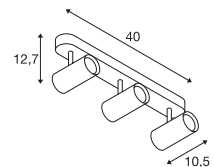

Versione	Articolo	EUR
● nero		
620lm 2700K 8W	1002969	105,00
○ bianco		
620lm 2700K 8W	1002970	105,00
● argento		
620lm 2700K 8W	1002971	105,00

Versione	Articolo	EUR
● nero		
1240lm 2700K 8W	1002973	169,00
○ bianco		
1240lm 2700K 8W	1002974	169,00
● argento		
1240lm 2700K 8W	1002975	169,00

Versione	Articolo	EUR
● nero		
1860lm 2700K 8W	1002976	251,00
○ bianco		
1860lm 2700K 8W	1002977	251,00
● argento		
1860lm 2700K 8W	1002978	251,00

1000131 403

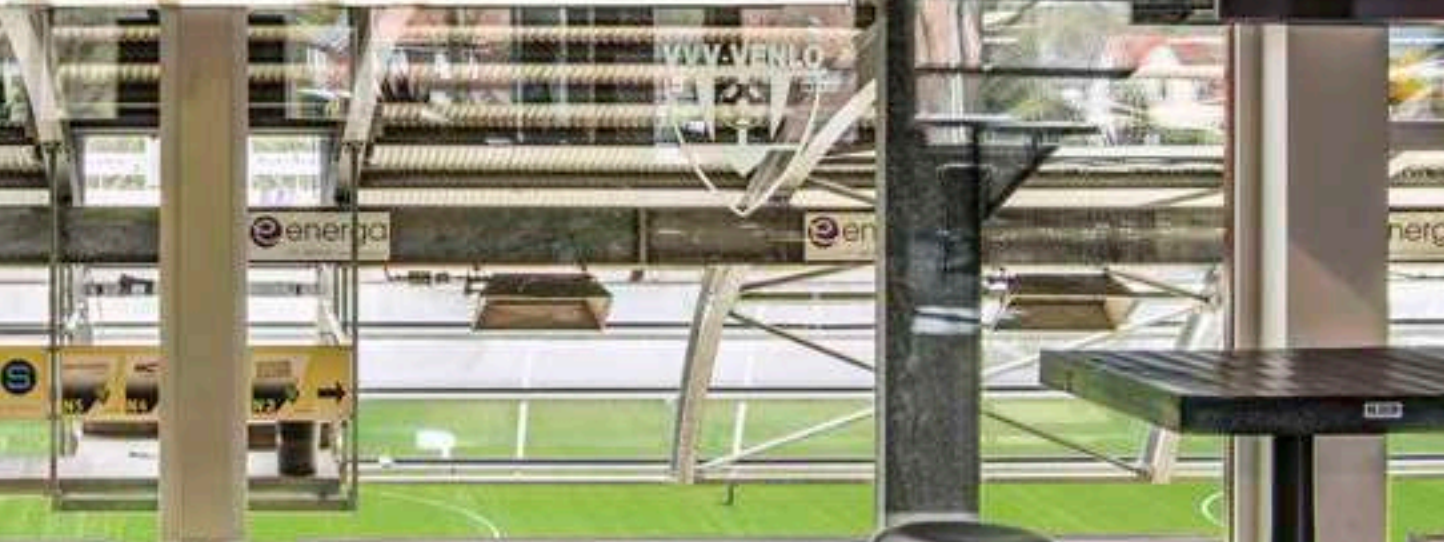



KALU

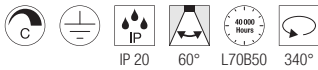

220-240V ~50/60Hz | 350mA
 Potenza assorbita: 17W
 Materiale: alluminio/policarbonato (PC)



Down

1000lm | 2000lm | 3000lm | 4000lm | 3000K

KALU CW, single, PHASE

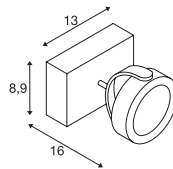

Versione	Articolo	EUR
● nero		
1000lm 3000K 17W	1000127	159,00
○ bianco		
1000lm 3000K 17W	1000128	159,00

KALU CW, double, PHASE

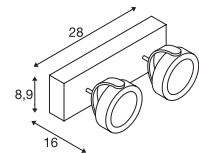

Versione	Articolo	EUR
● nero		
2000lm 3000K 17W	1000129	262,00
○ bianco		
2000lm 3000K 17W	1000130	262,00

KALU CW, triple, PHASE

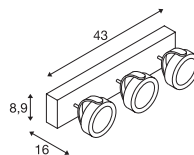

Versione	Articolo	EUR
● nero		
3000lm 3000K 17W	1000131	398,00
○ bianco		
3000lm 3000K 17W	1000132	398,00

KALU CW, quad, PHASE

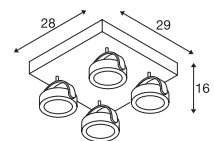

Versione	Articolo	EUR
● nero		
4000lm 3000K 17W	1000135	494,00
○ bianco		
4000lm 3000K 17W	1000136	494,00

147321 405

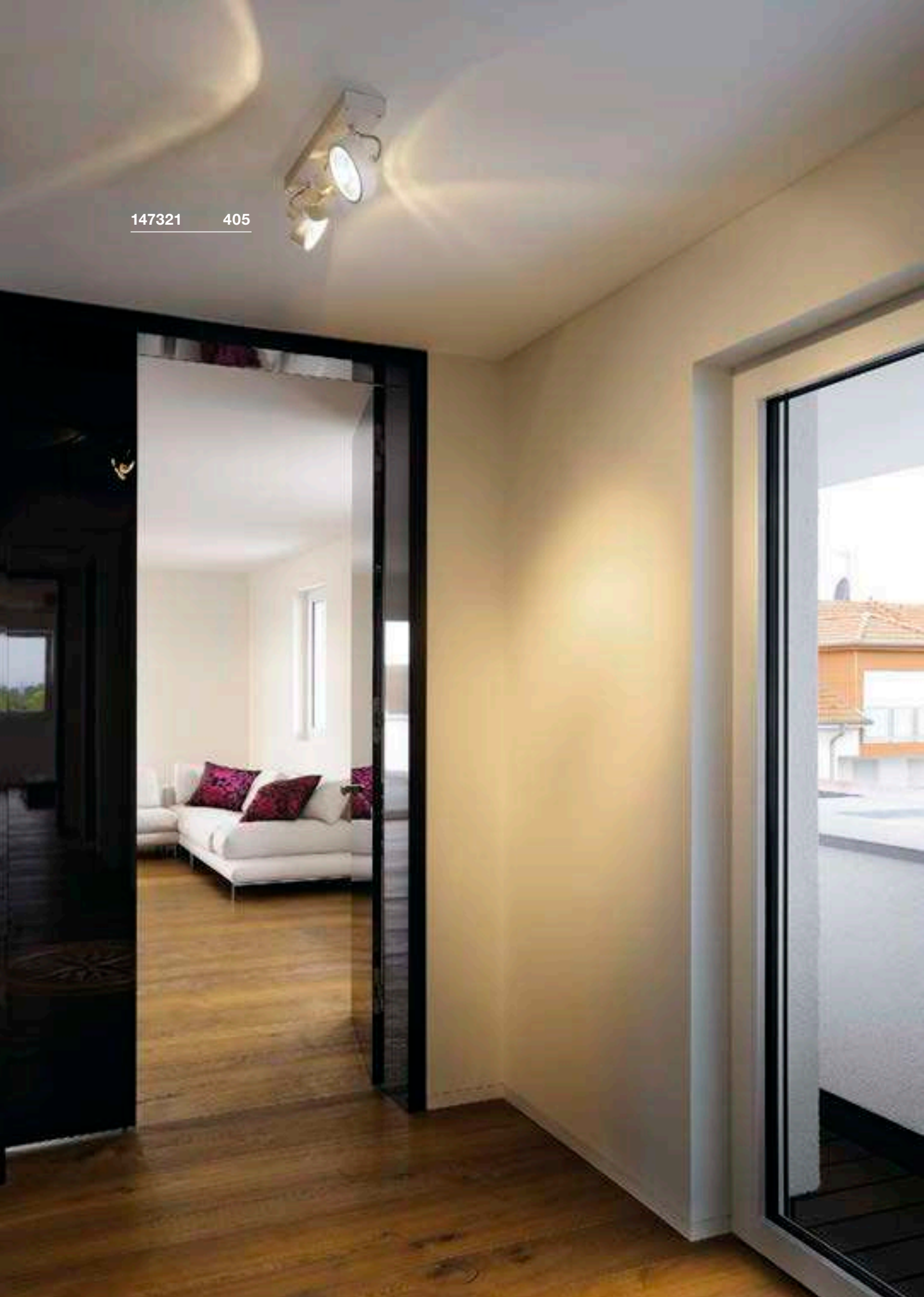



KALU

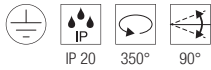

220-240V ~50/60Hz
Materiale: alluminio



Attacco: 1xGU10



QPAR111 | 8W | 38°
2700K | 680lm | Classe=F
8kWh/1000h



Articolo: 1005274 | 30,75 EUR

KALU CW, single, QPAR111

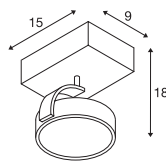

Versione	Articolo	EUR
● nero	1000702	75,00
○ bianco	147301	75,00
● alluminio	147306	78,00

KALU CW, double, QPAR111

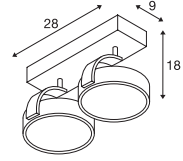

Versione	Articolo	EUR
● nero	1000703	149,00
○ bianco	147311	149,00
● alluminio	147316	159,00

KALU CW, triple, QPAR111

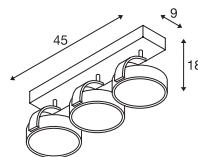

Versione	Articolo	EUR
● nero	1000704	206,00
○ bianco	147321	206,00
● alluminio	147326	217,00

KALU CW, quad, QPAR111

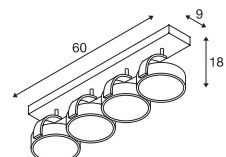

Versione	Articolo	EUR
● nero	1002023	289,00
○ bianco	1002024	289,00
● alluminio	1002025	299,00

152010 407





ENOLA B
CW, single, QPAR51

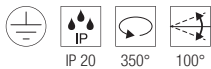
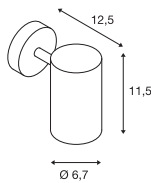

220-240V ~50/60Hz
Materiale: alluminio/acciaio

- Incluso anello decorativo nel colore della lampada
- Anello decorativo nero opzionale disponibile come accessorio.



Attacco: 1xGU10 max. L: 6,7 cm

Versione	Articolo	EUR
● nero	152010	73,00
○ bianco	152011	73,00

LED GU10 51mm | 6W | 38°
2700K | 450lm | Classe=F
6kWh/1000h

Articolo: 1005077 | 7,50 EUR

⊕

Articolo	Articolo	EUR
Anello decorativo		
● nero	151840	8,95

ENOLA B
CW, double, QPAR51

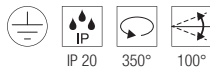
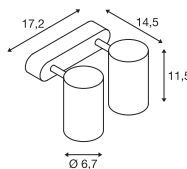

220-240V ~50/60Hz
Materiale: alluminio/acciaio

- Incluso anello decorativo nel colore della lampada
- Anello decorativo nero opzionale disponibile come accessorio.



Attacco: 2xGU10 max. L: 6,7 cm

Versione	Articolo	EUR
● nero	152020	125,00
○ bianco	152021	125,00

LED GU10 51mm | 6W | 38°
2700K | 450lm | Classe=F
6kWh/1000h

Articolo: 1005077 | 7,50 EUR

⊕

Articolo	Articolo	EUR
Anello decorativo		
● nero	151840	8,95

ENOLA B
CW, double, QPAR51

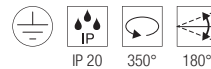
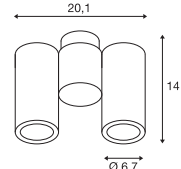

220-240V ~50/60Hz
Materiale: alluminio/acciaio

- Incluso anello decorativo nel colore della lampada
- Anello decorativo nero opzionale disponibile come accessorio.



Attacco: 2xGU10 max. L: 8 cm

Versione	Articolo	EUR
● nero	151830	156,00
○ bianco	151831	156,00

LED GU10 51mm | 6W | 38°
2700K | 450lm | Classe=F
6kWh/1000h

Articolo: 1005077 | 7,50 EUR

⊕

Articolo	Articolo	EUR
Anello decorativo		
● nero	151840	8,95

1002215 408



ALTRA DICE CW, double, QPAR51

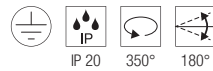
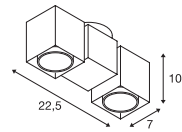

220-240V ~50/60Hz
Materiale: alluminio/acciaio

SOCKET INSIDE <50 W

Attacco: 2xGU10

Versione	Articolo	EUR
● nero	1002215	109,00
○ bianco	151531	109,00
● grigio	151534	109,00



LED GU10 51mm | 6W | 36°
2200-2700K | 360lm | Classe=G



Articolo: 1005273 | 9,99 EUR



147551 409



SPOT 79
CW, QPAR51

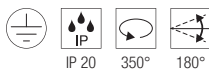
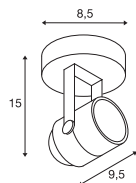

220-240V ~50/60Hz
Materiale: alluminio

SOCKET INSIDE <50 W

Attacco: 1xGU10 max. Ø: 5,1 cm | L: 5,7 cm

Versione	Articolo	EUR
● nero	132020	32,75
○ bianco	132021	32,75
● grigio	132024	32,75



LED GU10 51mm | 6W | 38°
2700K | 450lm | Classe=F
6kWh/1000h



Articolo: 1005077 | 7,50 EUR

INDA
CW, QPAR51

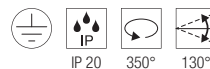
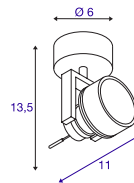

220-240V ~50/60Hz
Materiale: alluminio

SOCKET INSIDE <50 W

Attacco: 1xGU10 max. Ø: 5,1 cm | L: 5,7 cm

Versione	Articolo	EUR
● nero	147550	65,00
○ bianco	147551	65,00
● alluminio	147559	69,00



LED GU10 51mm | 6W | 38°
2700K | 450lm | Classe=F
6kWh/1000h



Articolo: 1005077 | 7,50 EUR





PURI

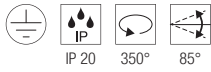

220-240V ~50/60Hz
 Materiale: alluminio/acciaio

- Anello decorativo incluso



Attacco: 1xGU10



LED GU10 51mm | 6W | 38°
 2700K | 450lm | Classe=F
 6kWh/1000h



Articolo: 1005077 | 7,50 EUR

PURI CW, single, QPAR51

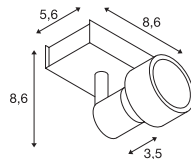

PURI CW, double, QPAR51

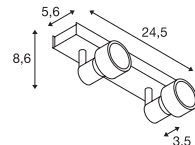

Versione	Articolo	EUR
● nero	147360	39,00
○ bianco	147361	39,00

Versione	Articolo	EUR
● nero	147370	79,00
○ bianco	147371	79,00

PURI CW, triple, QPAR51

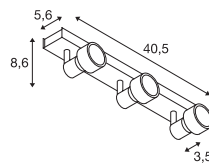

PURI CW, quad, QPAR51

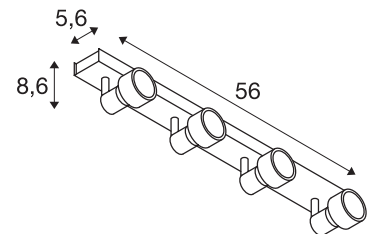

Versione	Articolo	EUR
● nero	147380	109,00
○ bianco	147381	109,00

Versione	Articolo	EUR
● nero	1002029	159,00
○ bianco	1002030	159,00

1000892 413





AVO

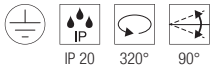

220-240V ~50/60Hz
Materiale: acciaio



Attacco: 1xGU10



LED GU10 51mm | 6W | 38°
2700K | 450lm | Classe=F
6kWh/1000h



Articolo: 1005077 | 7,50 EUR

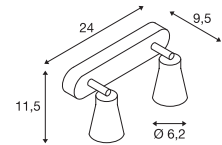
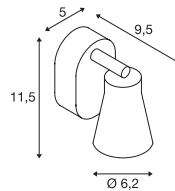

Versione	Articolo	EUR
● nero	1000886	45,25
○ bianco	1000887	45,25

Versione	Articolo	EUR
● nero	1000889	94,00
○ bianco	1000890	94,00

AVO CW, triple, QPAR51

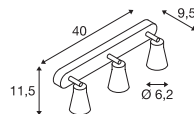

AVO CW, quad, QPAR51

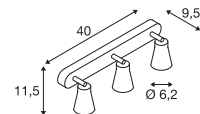

Versione	Articolo	EUR
● nero	1000892	117,00
○ bianco	1000893	117,00

Versione	Articolo	EUR
● nero	1000895	140,00
○ bianco	1000896	140,00



147443 415





ASTO

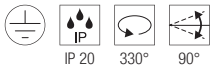

220-240V ~50/60Hz
Materiale: alluminio



Attacco: 1xGU10



LED GU10 51mm | 6W | 38°
2700K | 450lm | Classe=F
6kWh/1000h



Articolo: 1005075 | 7,50 EUR

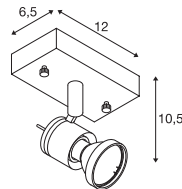

Versione	Articolo	EUR
● alluminio	147441	35,75

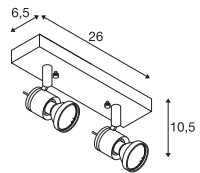

Versione	Articolo	EUR
● alluminio	147442	70,00

ASTO CW, triple, QPAR51

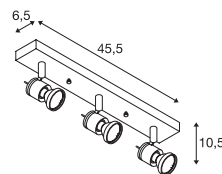

Versione	Articolo	EUR
● alluminio	147443	95,00

ASTO CW, quad, QPAR51

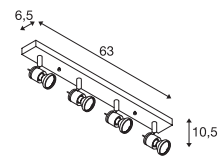

Versione	Articolo	EUR
● alluminio	147444	119,00

1004705 417

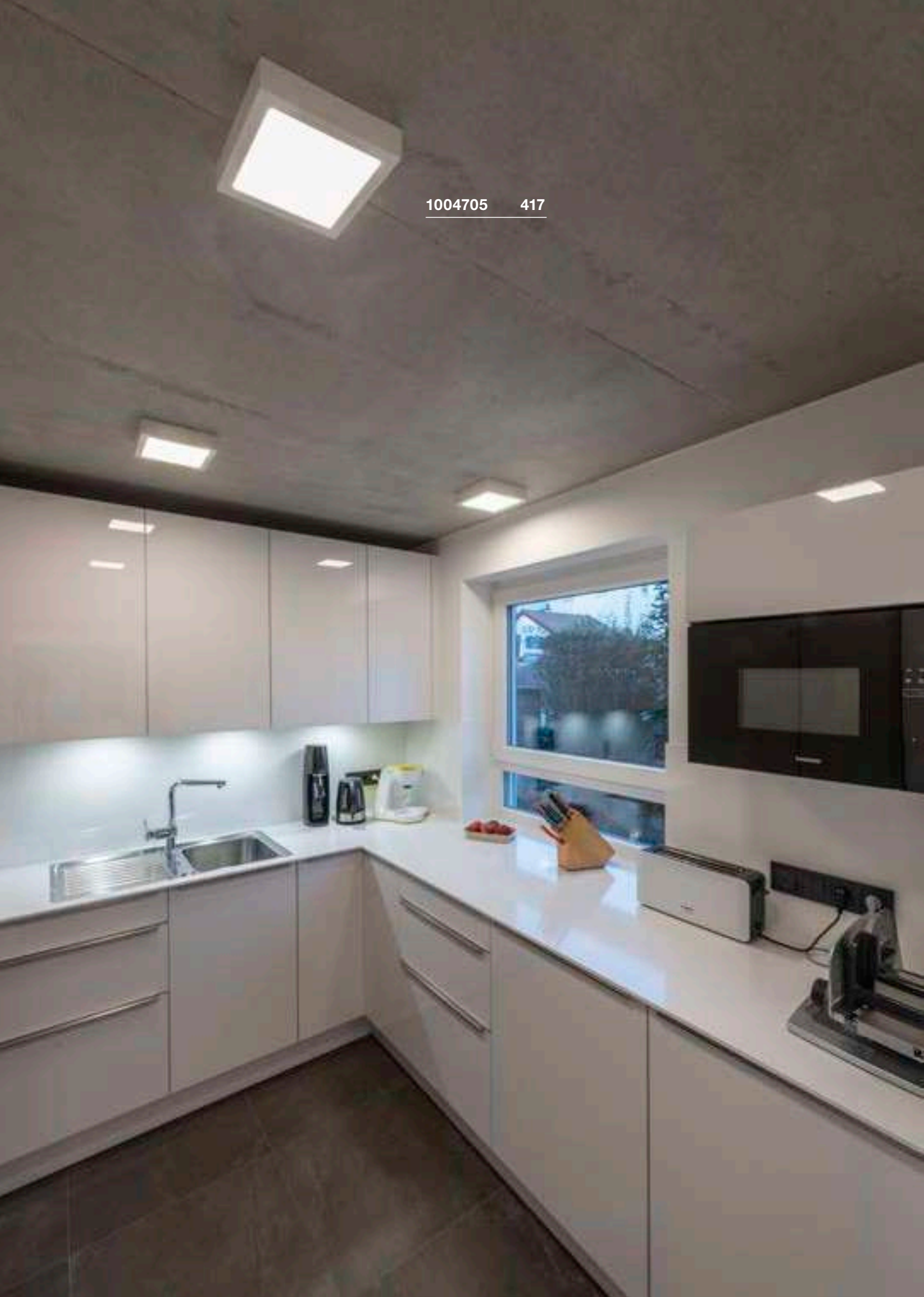



SENDER 12
CW, quadrato, PHASE

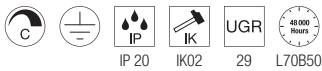
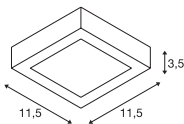

220-240V ~50/60Hz | 200mA
Potenza assorbita: 8,4W
Materiale: alluminio



Down 460lm | 3000K

Versione	Articolo	EUR
<input type="radio"/> bianco	1003017	74,00

SENDER 18
CW, quadrato, PHASE

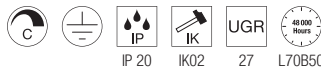
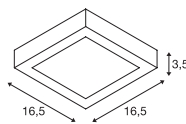

220-240V ~50/60Hz | 350mA
Potenza assorbita: 13W
Materiale: alluminio



Down 840lm | 3000K

Versione	Articolo	EUR
<input type="radio"/> bianco	1003018	79,00

SENDER 24
CW, quadrato, PHASE

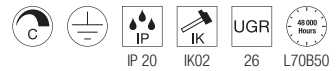
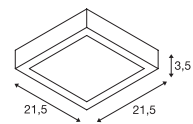

220-240V ~50/60Hz | 500mA
Potenza assorbita: 15W
Materiale: alluminio



Down 1140lm | 3000K
1240lm | 4000K

Versione	Articolo	EUR
<input type="radio"/> bianco		
1140lm 3000K	1003019	85,00
<input type="radio"/> bianco		
1240lm 4000K	1004705	85,00





SENSER 12
CW, rotondo, PHASE

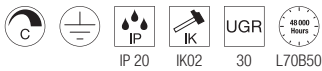
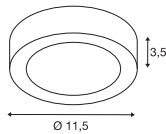

220-240V ~50/60Hz | 200mA
Potenza assorbita: 8,4W
Materiale: alluminio



Down 460lm | 3000K
470lm | 4000K

Versione	Articolo	EUR
○ bianco 460lm 3000K 8.4W	1003014	74,00
○ bianco 470lm 4000K 8.2W	1004700	74,00

SENSER 18
CW, rotondo, PHASE

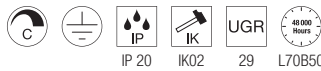
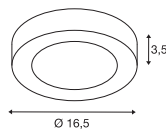

220-240V ~50/60Hz | 350mA
Potenza assorbita: 13W
Materiale: alluminio



Down 830lm | 3000K
990lm | 4000K

Versione	Articolo	EUR
○ bianco 830lm 3000K 13W	1003015	79,00
○ bianco 990lm 4000K 12W	1004701	79,00

SENSER 24
CW, rotondo, PHASE

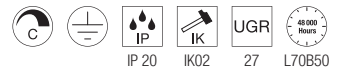
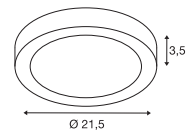

220-240V ~50/60Hz | 500mA
Potenza assorbita: 15W
Materiale: alluminio



Down 1140lm | 3000K
1300lm | 4000K

Versione	Articolo	EUR
○ bianco 1140lm 3000K	1003016	85,00
○ bianco 1300lm 4000K	1004702	85,00

SIMA
CW, rotondo, Sensor

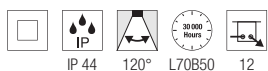
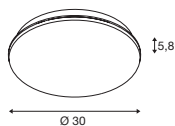

220-240V ~50/60Hz | 320mA
Potenza assorbita: 24W
Materiale: policarbonato (PC)



Down 2200lm | 3000K

Versione	Articolo	EUR
○ bianco	1005086	176,00

SIMA
CW, rotondo, PHASE

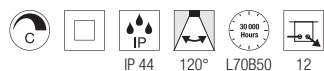
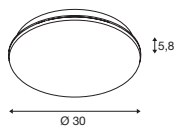

220-240V ~50/60Hz | 320mA
Potenza assorbita: 24W
Materiale: policarbonato (PC)



Down 2200lm | 3000K

Versione	Articolo	EUR
○ bianco	1005085	152,00

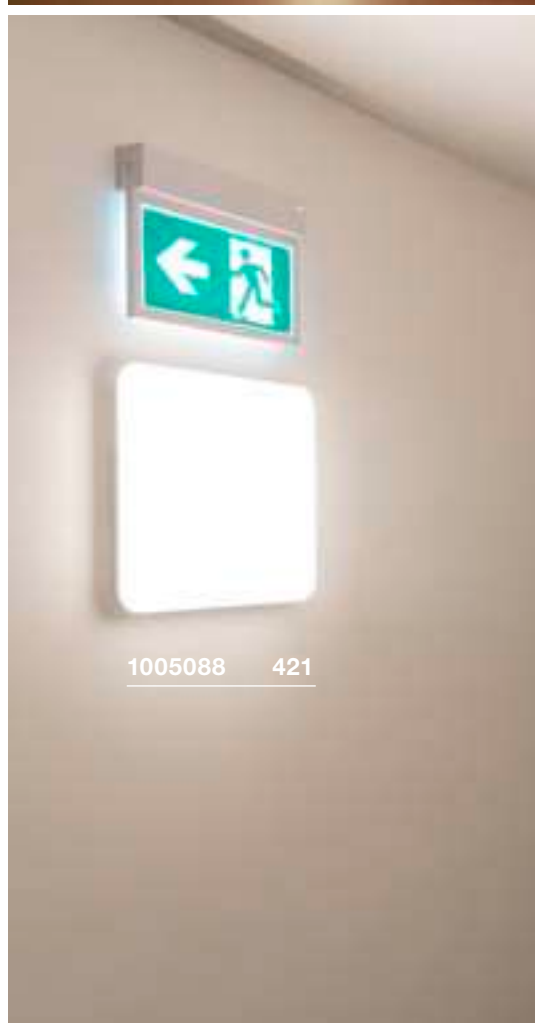
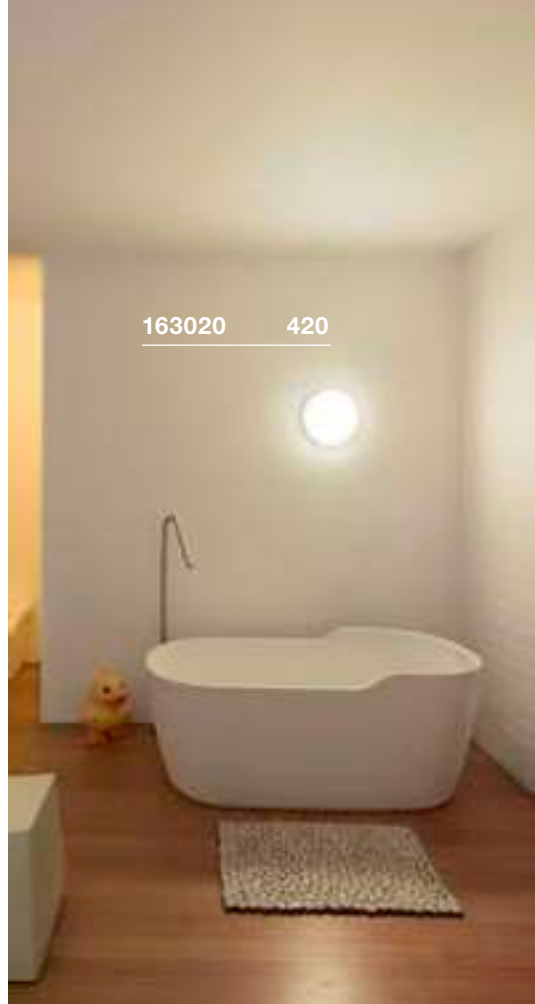



1005087 421

SIMA
CW, quadrato, Sensor

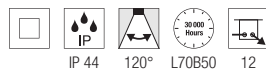
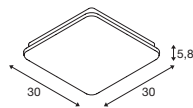

220-240V ~50/60Hz | 320mA
Potenza assorbita: 24W
Materiale: policarbonato (PC)



Down 2200lm | 3000K

Versione	Articolo	EUR
○ bianco	1005088	176,00

SIMA
CW, quadrato, PHASE

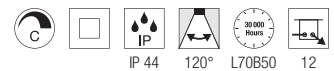
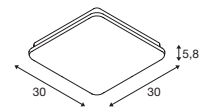

220-240V ~50/60Hz | 320mA
Potenza assorbita: 24W
Materiale: policarbonato (PC)



Down 2200lm | 3000K

Versione	Articolo	EUR
○ bianco	1005087	152,00



1002021 423





LIPSY® 30
CW, Dome

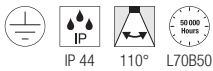
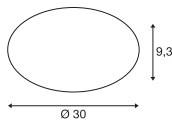

220-240V ~50/60Hz | 350mA
Potenza assorbita: 13,5W
Materiale: alluminio/policarbonato (PC)



Down 1550lm | 3000K | 1600lm | 4000K

Versione	Articolo	EUR
○ bianco	1002020	90,00

LIPSY® 40
CW, Dome

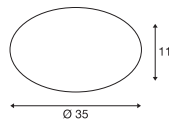

220-240V ~50/60Hz | 500mA
Potenza assorbita: 17,5W
Materiale: alluminio/policarbonato (PC)



Down 2050lm | 3000K | 2200lm | 4000K

Versione	Articolo	EUR
○ bianco	1002021	111,00

LIPSY® 50
CW, Dome

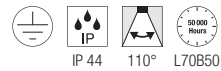
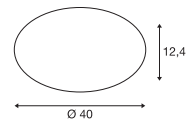

220-240V ~50/60Hz | 500mA
Potenza assorbita: 20W
Materiale: alluminio/policarbonato (PC)



Down 2500lm | 3000K | 2700lm | 4000K

Versione	Articolo	EUR
○ bianco	1002022	121,00

1002076 425





LIPSY® 30
CW, Drum

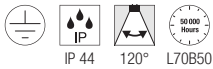
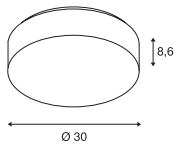

220-240V ~50/60Hz | 350mA
Potenza assorbita: 13,5W
Materiale: alluminio/policarbonato (PC)



Down 1600lm | 3000K | 1650lm | 4000K

Versione	Articolo	EUR
○ bianco	1002075	100,00

LIPSY® 40
CW, Drum

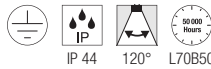
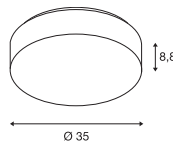

220-240V ~50/60Hz | 500mA
Potenza assorbita: 17,5W
Materiale: alluminio/policarbonato (PC)



Down 2100lm | 3000K | 2300lm | 4000K

Versione	Articolo	EUR
○ bianco	1002076	111,00

LIPSY® 50
CW, Drum

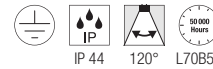
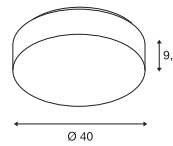

220-240V ~50/60Hz | 500mA
Potenza assorbita: 20W
Materiale: alluminio/policarbonato (PC)



Down 2450lm | 3000K | 2600lm | 4000K

Versione	Articolo	EUR
○ bianco	1002077	121,00



1002940 426



1002941 426

LIPSY® 40 CW, Drum, DALI

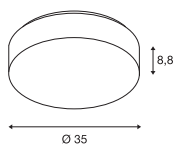

LIPSY® 50 CW, Drum, DALI

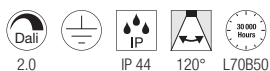
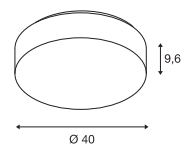

220-240V ~50/60Hz | 500mA
Potenza assorbita: 18W
Materiale: alluminio/policarbonato (PC)
Dimmabile: DALI



Down 2100lm | 3000K | 2300lm | 4000K

Versione	Articolo	EUR
○ bianco	1002940	201,00

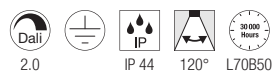

220-240V ~50/60Hz | 500mA
Potenza assorbita: 21W
Materiale: alluminio/policarbonato (PC)
Dimmabile: DALI



Down 2450lm | 3000K | 2600lm | 4000K

Versione	Articolo	EUR
○ bianco	1002941	212,00

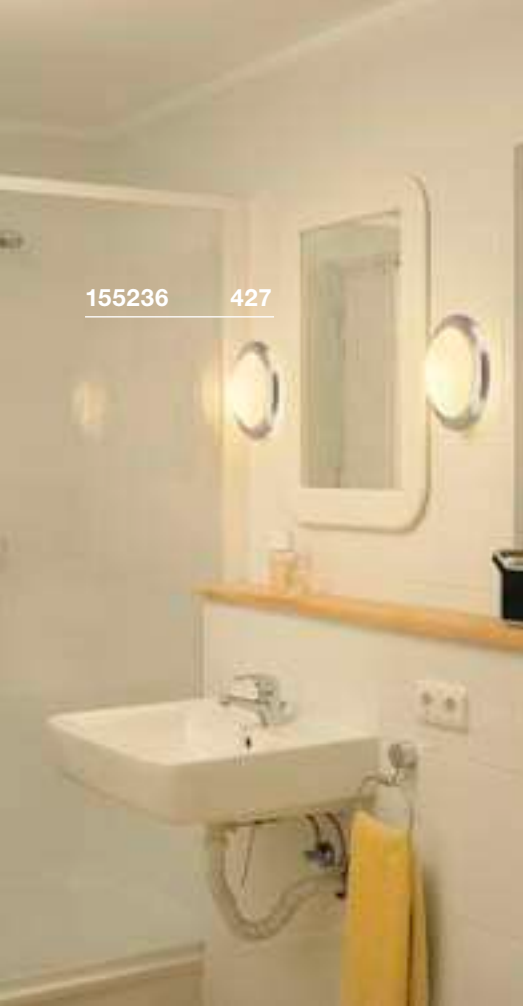

155236 427

MELAN
CW, E27

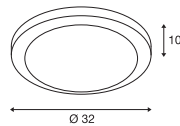

GLASSA
CW, quadrato, E27

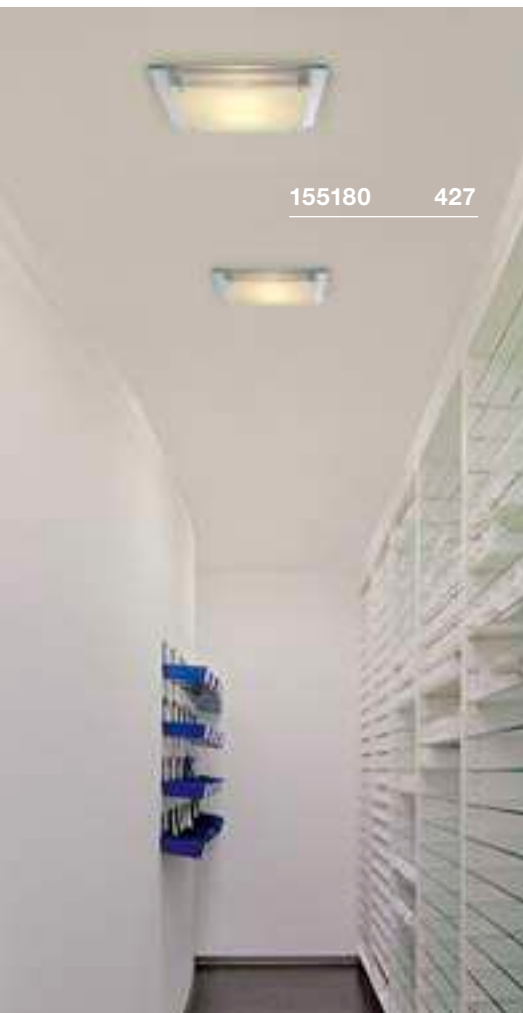
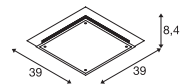

155180 427



220-240V ~50/60Hz
Materiale: alluminio/vetro



Attacco: 1xE27 Ø max.: 7 cm L: 16 cm

Versione	Articolo	EUR
● alluminio	155236	122,00



A60 | 7,5W | 320°
2700K | 800lm | Classe=F
8kWh/1000h



Articolo: 1005303 | 9,60 EUR



220-240V ~50/60Hz
Materiale: acciaio/vetro



Attacco: 2xE27 Ø max.: 4,8 cm L: 14,8 cm

Versione	Articolo	EUR
● trasparente/cromo	155180	137,00



LED E27 | 8W | 240°
4000K | 920lm | Classe=E
8kWh/1000h



Articolo: 1005290 | 10,25 EUR

1006124 429





BATTEN 60 CW

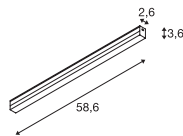

220-240V ~50/60Hz | 110mA
Potenza assorbita: 9W
Materiale: policarbonato (PC)

- Interruttore sull'alloggiamento lampada
- Cavo di alimentazione da acquistare a parte



Down 940lm | 3000K | 980lm | 4000K

Versione	Articolo	EUR
<input type="radio"/> bianco	1006123	53,00



Articolo	Articolo	EUR
Raccordo diretto		
<input type="radio"/> bianco	1006128	2,40
Cavo di alimentazione con spina		
<input type="radio"/> bianco	1006125	10,40
Staffe di fissaggio		
<input type="radio"/> bianco	1006126	2,00
Raccordo lungo cavo 60 cm		
<input type="radio"/> bianco	1006127	5,80

BATTEN 120 CW

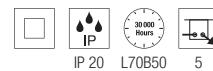
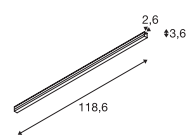

220-240V ~50/60Hz | 220mA
Potenza assorbita: 18W
Materiale: policarbonato (PC)

- Interruttore sull'alloggiamento lampada
- Cavo di alimentazione da acquistare a parte



Down 1900lm | 3000K | 1960lm | 4000K

Versione	Articolo	EUR
<input type="radio"/> bianco	1006124	66,00



Articolo	Articolo	EUR
Raccordo diretto		
<input type="radio"/> bianco	1006128	2,40
Cavo di alimentazione con spina		
<input type="radio"/> bianco	1006125	10,40
Staffe di fissaggio		
<input type="radio"/> bianco	1006126	2,00
Raccordo lungo cavo 60 cm		
<input type="radio"/> bianco	1006127	5,80

LONG GRILL CW

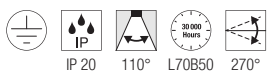
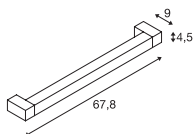

220-240V ~50/60Hz | 700mA
Potenza assorbita: 20W
Materiale: alluminio/acrilico



Down 1600lm | 3000K

Versione	Articolo	EUR
● nero	1001020	297,00
○ bianco	1001019	297,00

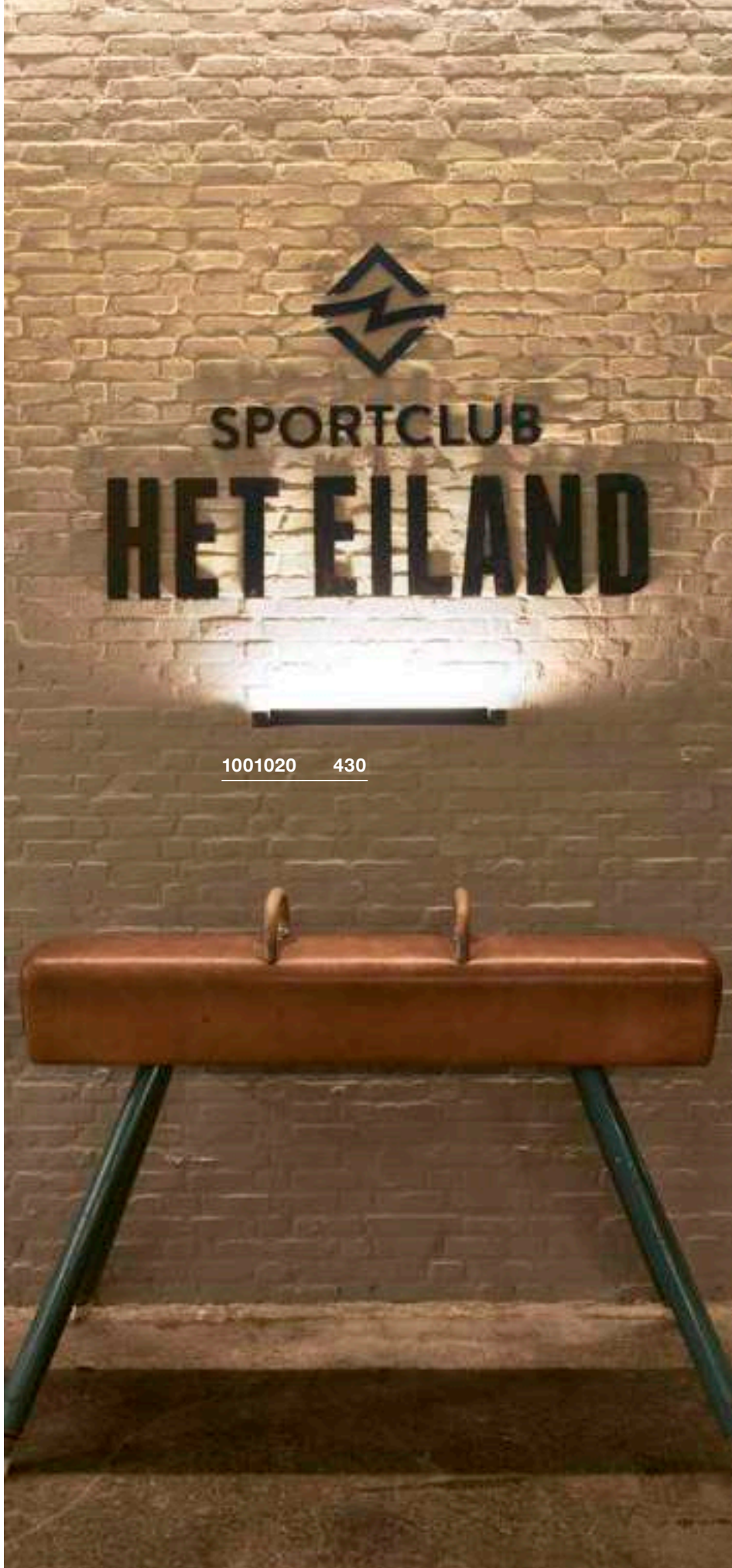

1001020 430



SIGHT 60
CW

SIGHT 115
CW

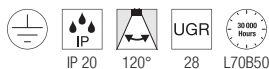
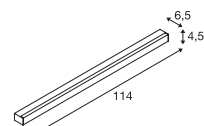
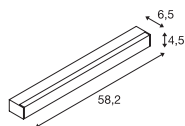
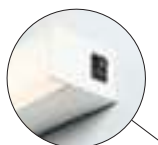

220-240V ~50/60Hz | 700mA
Potenza assorbita: 20W
Materiale: alluminio/acrilico

220-240V ~50/60Hz | 700mA
Potenza assorbita: 38W
Materiale: alluminio/acrilico

- Interruttore sull'alloggiamento lampada



Down 1490lm | 3000K



Down 3100lm | 3000K

Versione	Articolo	EUR
● nero	1001283	232,00
○ bianco	1001284	232,00

Versione	Articolo	EUR
● nero	1001286	323,00
○ bianco	1001287	323,00

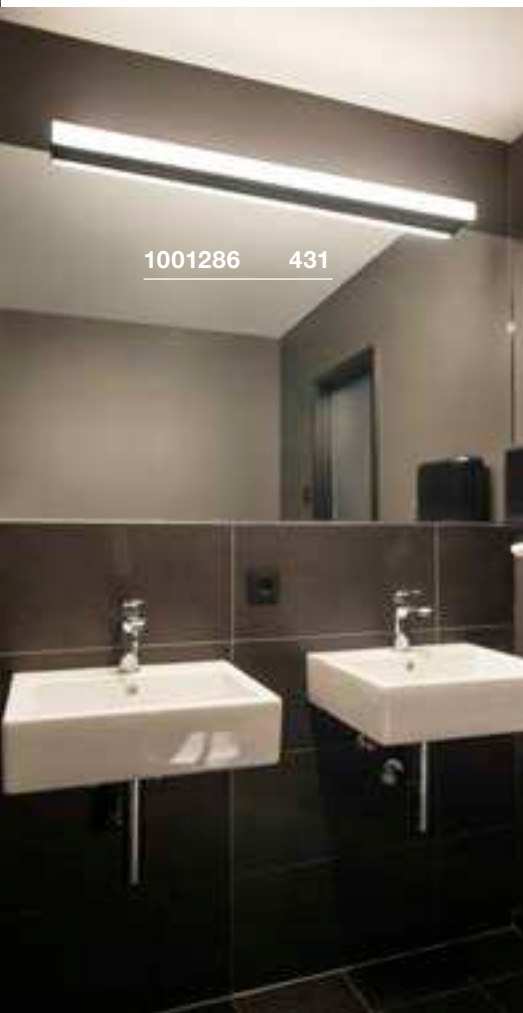

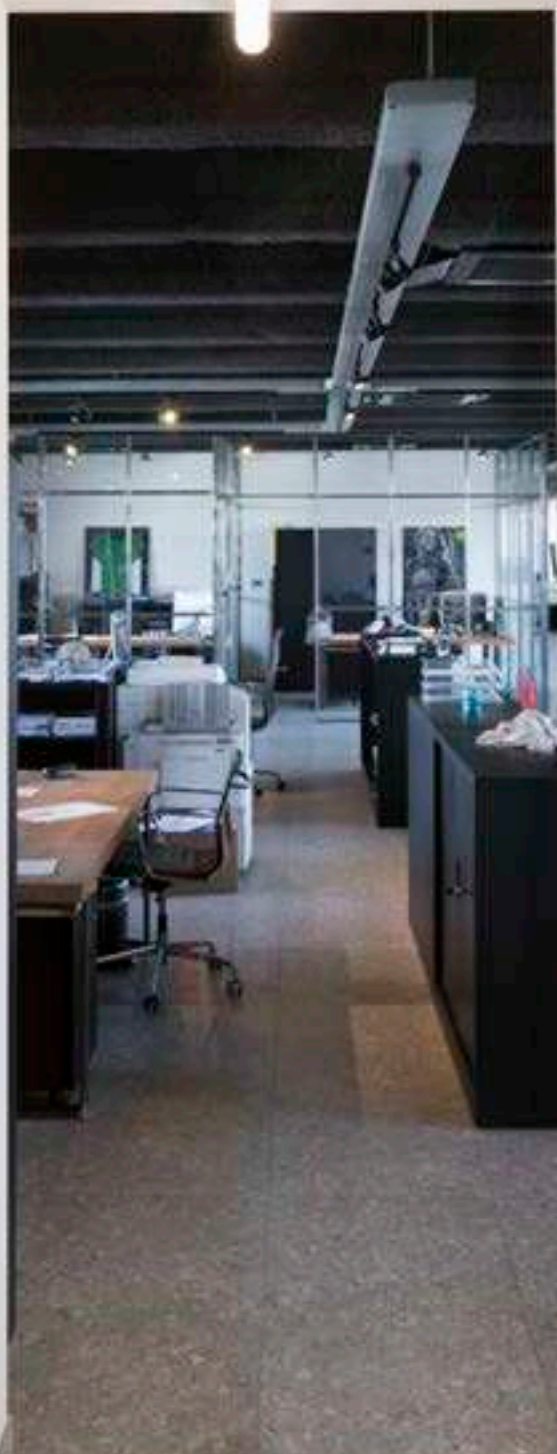

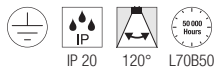
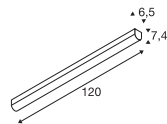

631337 433

BENA 120
CW

220-240V ~50/60Hz | 700mA
Potenza assorbita: 28W
Materiale: polimetilmetacrilato (PMMA)/acciaio



Down 3800lm | 3000K

Versione	Articolo	EUR
<input type="radio"/> bianco	631337	174,00

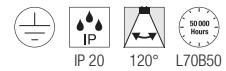
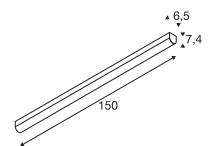
BENA 150
CW

220-240V ~50/60Hz | 700mA
Potenza assorbita: 36W
Materiale: polimetilmetacrilato (PMMA)/acciaio



Down 5000lm | 3000K

Versione	Articolo	EUR
<input type="radio"/> bianco	631339	211,00



1007697 439





NEW

ONE®
alle pagine
196-197

LED



NEW

LED

VINOLINA ONE | 437



NEW

LED

VINOLINA | 437



NEW

LED

VINOLINA TWO | 439



NEW

LED

TAHA | 441



NEW

SCKET

TINY SUN | 443



NEW

SCKET

LITTLE SUN | 443



NEW

SCKET

VARYT | 443



NEW

LED

WORKLIGHT PRO | 444



NEW

LED

WORKLIGHT PRO | 444



LED

WORKLIGHT | 445



LED

WORKLIGHT | 445



SCKET

FENDA | 447



SCKET

FENDA | 447



SCKET

FENDA | 447



SCKET

FENDA | 448



SCKET

FENDA BOW BASIS | 448



FENDA | 448



FENDA | 449



FENDA | 449



FENDA | 449



LED

KARPO | 452



LED

KARPO | 452



SCKET

PHELIA | 453



LED

TONILA | 453



LED

MAGANDA | 453



1007357 437

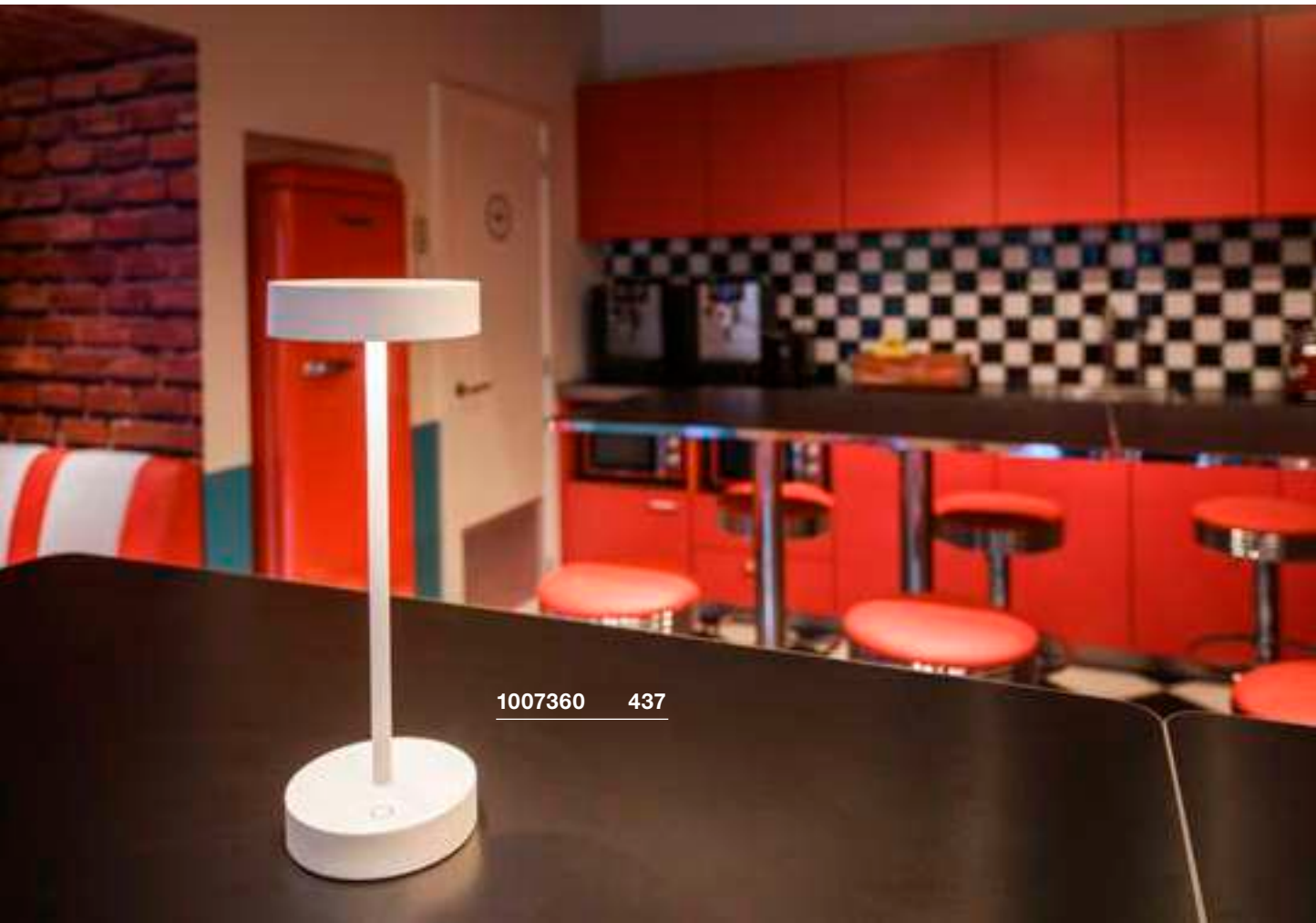

1007360 437



VINOLINA ONE TL, Batteria ricaricabile

VINOLINA TL, Batteria ricaricabile

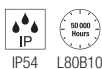
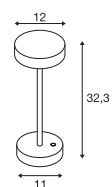
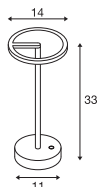
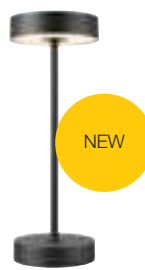
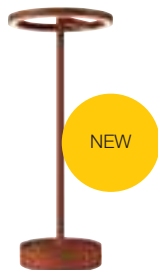

Funzionamento a batteria a 5V
Potenza assorbita: 2,5W
Materiale: alluminio

- Durata 12h
- Tempo di carica 7h
- Piastra di carica inclusa
- Alimentatore escluso
- USB A



Funzionamento a batteria a 5V
Potenza assorbita: 2,2W
Materiale: alluminio

- Durata 12h
- Tempo di carica 7h
- Piastra di carica inclusa
- Alimentatore escluso
- USB A



Down 125lm | 2700K



Down 130lm | 2700K | 130lm | 3000K

Versione	Articolo	EUR
● nero	1007359	139,00
○ bianco	1007357	139,00
● ruggine	1007358	139,00

Versione	Articolo	EUR
● nero	1007362	139,00
○ bianco	1007360	139,00
● ruggine	1007361	139,00



1007692 439



VINOLINA TWO

TL, Batteria ricaricabile

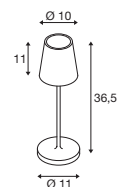

IP65 L70B20

Funzionamento a batteria a 5V

Potenza assorbita: 2W

Materiale: alluminio

- Dimmerabile TOUCH
- Durata 10h
- Tempo di carica 5h
- Compresa base di ricarica



Down

190lm

2200K
2700K
3000K

Versione	Articolo	EUR
● nero	1007693	139,00
○ bianco	1007692	139,00
● sabbia	1007697	139,00
● ruggine	1007695	139,00
● rosso	1007694	139,00
● verde salvia	1007696	139,00



1007380 441



TAHA

Set lampada, batteria

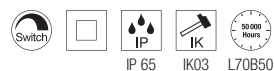

100-240V ~50/60Hz | Funzionamento a batteria da 5V
 Potenza assorbita: 5W
 Max. voltaggio driver: 5V DC
 Materiale: alluminio/plastica

- Cavo di ricarica incluso



Down

200lm | 2700K

Versione	Articolo	EUR
● nero	1007380	● 159,00





TINY SUN
TL

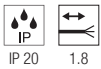
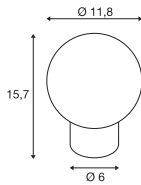

220-240V ~50/60Hz
Materiale: acciaio

- Spina europea



Attacco: 1xGU9 Ø max.: 3 cm L: 6 cm

Versione	Articolo	EUR
rame	1007364	99,00
bronzo	1007363	99,00



LED G9 | 3,6W | 300°
3000K | 400lm | Classe=E
4kWh/1000h

Articolo: 1005286 | 9,99 EUR

LITTLE SUN
TL

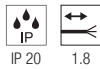
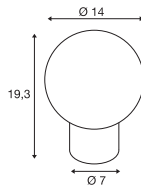

220-240V ~50/60Hz
Materiale: acciaio

- Spina europea



Attacco: 1xGU9 Ø max.: 3 cm L: 6 cm

Versione	Articolo	EUR
rame	1007366	109,00
bronzo	1007365	109,00



LED G9 | 3,6W | 300°
3000K | 400lm | Classe=E
4kWh/1000h

Articolo: 1005286 | 9,99 EUR

VARYT
TL, E14

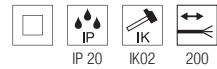
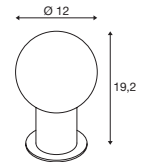

220-240V ~50/60Hz
Materiale: alluminio/acciaio

- Spina europea



Attacco: 1xE14 Ø max.: 3,8 cm L: 11 cm

Versione	Articolo	EUR
nero	1007620	145,00
bianco	1007622	145,00
ottone	1007623	180,00
cromo	1007621	160,00



C35 | 4,2W | 320°
2700K | 350lm | Classe=G
5kWh/1000h

Articolo: 1005285 | 8,50 EUR



WORKLIGHT PRO
FL, single

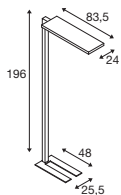
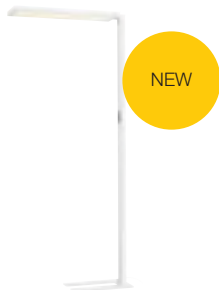

200-240V ~50/60Hz | 48V
Potenza assorbita: 100W
Materiale: alluminio/acciaio

- Spina Schuko
- Dimmerabile tramite funzione touch



Up 10700lm | 4000K
Down 2300lm

Versione	Articolo	EUR
● nero	1007462	950,00
○ bianco	1007463	950,00
● grigio	1007464	950,00

WORKLIGHT PRO
FL, double

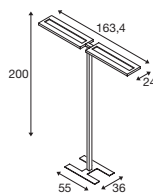
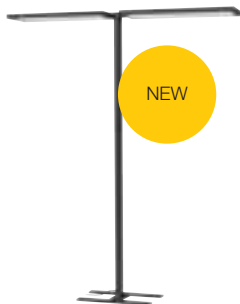

200-240V ~50/60Hz | 48V
Potenza assorbita: 150W
Materiale: alluminio/acciaio

- Spina Schuko
- Dimmerabile tramite funzione touch



Up 15600lm | 4000K
Down 4400lm

Versione	Articolo	EUR
● nero	1007465	1.749,00
○ bianco	1007466	1.749,00
● grigio	1007467	1.749,00



1007464 444



1007466 444



1006344 445

WORKLIGHT TL

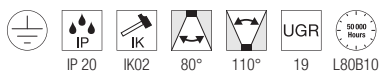
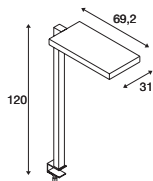

200-240V ~50/60Hz | 2000mA
Potenza assorbita: 79W
Materiale: alluminio

- Apertura del morsetto: 6-40 mm
- Spina Schuko
- Dimmerabile tramite funzione touch



Up 3800lm | 4000K
Down 3800lm

Versione	Articolo	EUR
● nero	1005392	699,00
○ bianco	1005394	699,00
● argento	1006344	699,00

WORKLIGHT FL

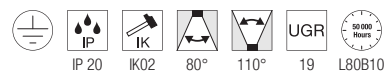
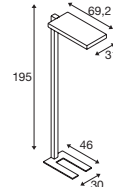

200-240V ~50/60Hz | 2000mA
Potenza assorbita: 79W
Materiale: alluminio

- Spina Schuko
- Dimmerabile tramite funzione touch



Up 3800lm | 4000K
Down 3800lm

Versione	Articolo	EUR
● nero	1005390	799,00
○ bianco	1005391	799,00
● argento	1006343	799,00



1005391 445



132660 + 1000580 296 + 449

155790 + 155592 447 + 449

155780 + 155592 447 + 449

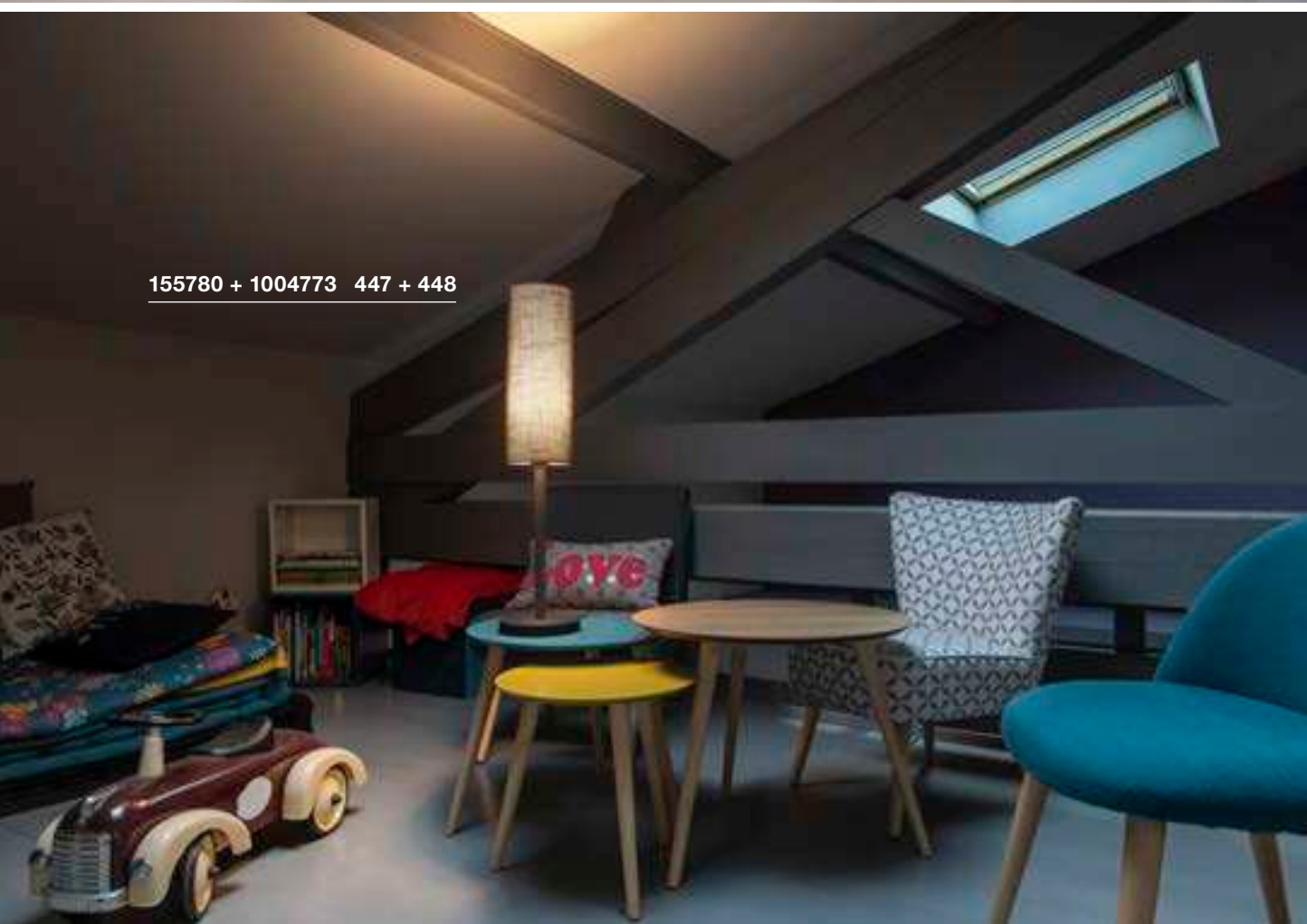

155780 + 1004773 447 + 448



FENDA TL, E27

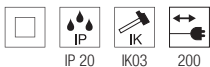
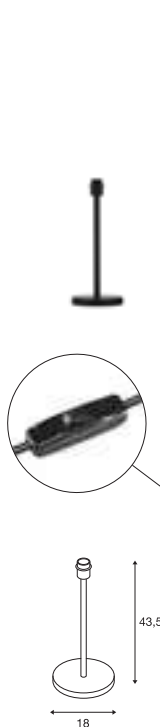

220-240V ~50/60Hz
Materiale: acciaio

- Spina europea e interruttore



Attacco: 1xE27

Versione	Articolo	EUR
● nero	155780	80,00

A60 | 7,5W | 320°
 2700K | 800lm | Classe=F
 8kWh/1000h

Articolo: 1005303 | 9,60 EUR

FENDA FL, E27



220-240V ~50/60Hz
Materiale: acciaio/plastica

- Spina europea e interruttore



Attacco: 1xE27

Versione	Articolo	EUR
● nero	155790	141,00

LED E27 | 13,2W | 220°
 2700K | 1300lm | Classe=F
 13kWh/1000h

Articolo: 1005302 | 12,25 EUR

FENDA TL, E27

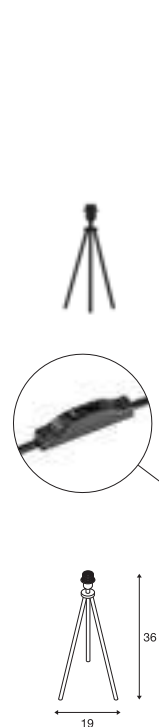

220-240V ~50/60Hz
Materiale: alluminio/plastica

- Spina europea e interruttore



Attacco: 1xE27

Versione	Articolo	EUR
● nero	155540	80,00

LED E27 | 7,5W | 320°
 2500K | 700lm | Classe=F
 8kWh/1000h

Articolo: 1005265 | 26,50 EUR

FENDA
FL, E27

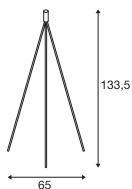

220-240V ~50/60Hz
Materiale: alluminio

- Interruttore sul vano ottico
- Spina europea



Attacco: 1xE27

Versione	Articolo	EUR
● nero	155490	132,00



LED E27 | 13,2W | 220°
2700K | 1300lm | Classe=F
13kWh/1000h



Articolo: 1005302 | 12,25 EUR

FENDA BOW BASIS
FL, E27

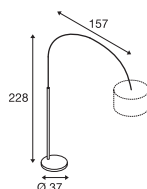

220-240V ~50/60Hz
Materiale: acciaio

- Peso massimo del diffusore: 900 g
- Spina europea e interruttore



Attacco: 1xE27

max. L: 17,5 cm

Versione	Articolo	EUR
● nero	1003029	248,00
● cromo	1000763	262,00



A60 | 7,5W | 320°
2700K | 800lm | Classe=F
8kWh/1000h



Articolo: 1005303 | 9,60 EUR

FENDA
15 cm, rotondo



H: 40 cm
Ø: 15 cm
Materiale: tessuto/acciaio

Versione	Articolo	EUR
●● nero/rame	156152	53,00
○ bianco	156141	44,75
● grigio	1004773	44,75
● beige	156143	44,75



155490 + 1004773 448 + 449



FENDA
30 cm, rotondo



H: 20 cm
Ø: 30 cm
Materiale: tessuto/acciaio

FENDA
Ø 45 cm, rotondo



H: 28 cm
Ø: 45,5 cm
Materiale: tessuto/acciaio

FENDA
Ø 70 cm, rotondo



H: 36 cm
Ø: 70 cm
Materiale: tessuto/acciaio

- Non adatto alla base FENDA BOW BASIS

Versione	Articolo	EUR
●● nero/rame	155592	70,00
○ bianco	155582	53,00
● grigio	1004774	53,00
● beige	155583	53,00

Versione	Articolo	EUR
●● nero/rame	156122	88,00
○ bianco	156111	83,00
● grigio	1004775	83,00
● beige	156113	83,00

Versione	Articolo	EUR
●● nero/rame	1000580	129,00
○ bianco	1000579	112,00



1003032 448

MIX & MATCH FENDA

FENDA Ø15

Nero	156152
Bianco	156141
Beige	156143
Grigio	1004773

FENDA Ø30

Nero	155592
Bianco	155582
Beige	155583
Grigio	1004774

FENDA Ø45

Nero	156122
Bianco	156111
Beige	156113
Grigio	1004775

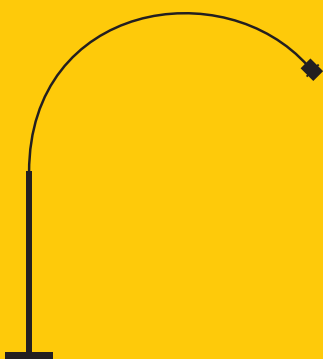

FENDA BOW

Nero	1003029
Cromo	1000763



FENDA TL

Nero	155780
------	--------



FENDA FL

Nero	155790
------	--------



FENDA TL

Nero	155540
------	--------

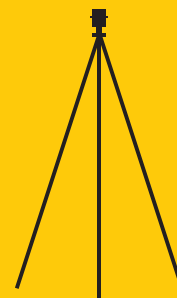

FENDA FL

Nero	155490
------	--------

Abbinare tra loro i prodotti Mix & Match a tuo piacimento. Sono fatti gli uni per gli altri e potrai sbizzarrirti a mescolare non soltanto gli articoli all'interno della famiglia FENDA, ma anche combinare quelli delle linee FENDA e FITU. I prodotti Mix & Match di SLV sono contraddistinti dal seguente simbolo:



MIX
match

FENDA Ø70

Nero | 1000580
Bianco | 1000579

FENDA Ø12,5

Glass Shade

Marrone | 1000773

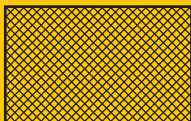

FITU CRANE BASE può essere abbinata anche a FENDA PD e ai diffusori FENDA.

FENDA PD

Nero | 132660
Bianco | 132661
Cromo | 132662

FENDA CL

Nero | 155550
Bianco | 155551

FITU CRANE BASE

Nero | 1004682



FITU PD

Nero | 132690
Bianco | 132691

KARPO
TL

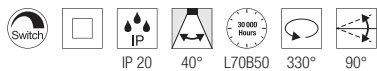
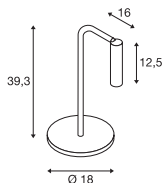

200-240V ~50/60Hz | 500mA
Potenza assorbita: 6,2W
Materiale: alluminio

- Interruttore nel corpo lampada
- Alimentatore



Down 360lm | 430lm | 3000K

Versione	Articolo	EUR
● nero 360lm	1001461	186,00
○ bianco 430lm	1001460	186,00

KARPO
FL

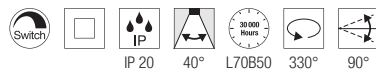
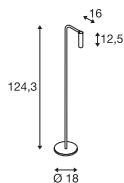

200-240V ~50/60Hz | 500mA
Potenza assorbita: 6,2W
Materiale: alluminio

- Interruttore nel corpo lampada
- Alimentatore



Down 360lm | 430lm | 3000K

Versione	Articolo	EUR
● nero 360lm	1001463	242,00
○ bianco 430lm	1001462	242,00

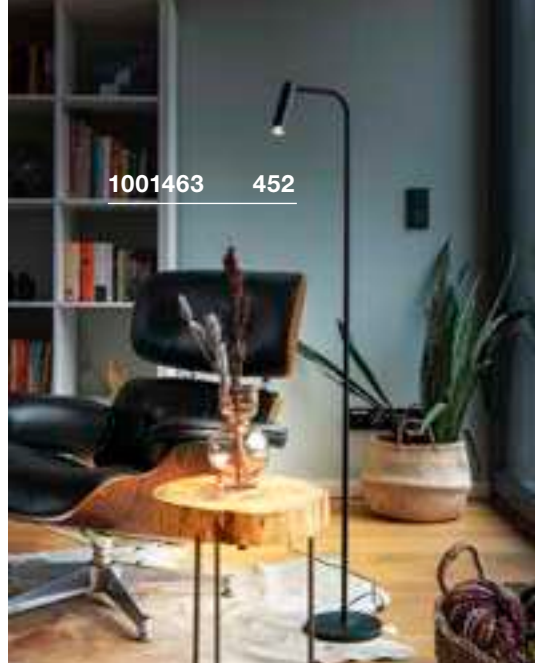

1001463 452

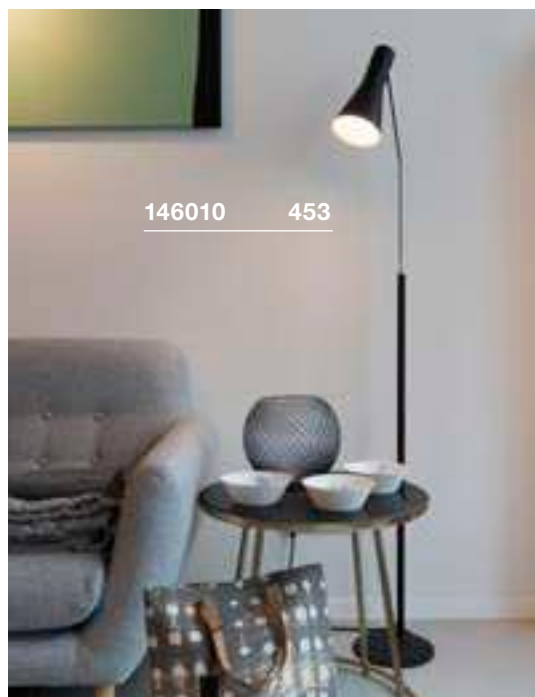

146010 453



1002583 453



PHELIA FL, E27

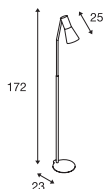

220-240V ~50/60Hz
Materiale: alluminio/acciaio

- Interruttore sul corpo lampada
- Spina europea e interruttore



Attacco: 1xE27 Ø max.: 5,3 cm L: 18 cm

Versione	Articolo	EUR
● nero	146010	242,00



A60 | 7,5W | 320°
2700K | 800lm | Classe=F
8kWh/1000h



Articolo: 1005303 | 9,60 EUR

TONILA TL

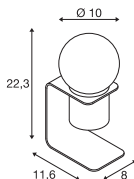

Funzionamento a batteria a 5V
Potenza assorbita: 1,6W
Materiale: alluminio/plastica

- Batteria 3,6V 2000 mAh inclusa
- Necessari caricabatterie USB 5V DC 2A e cavo di ricarica micro-USB (non inclusi)
- Dimmerabile su 3 livelli tramite pulsante



Down 90lm | 2700K

Versione	Articolo	EUR
● nero	1002583	118,00

MAGANDA TL

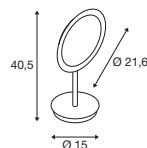

100-240V ~50/60Hz | 12V
Potenza assorbita: 4,8W
Materiale: acciaio/vetro

- Temperatura del colore selezionabile in 3 tonalità tramite pulsante
- Spina Schuko IP44



45lm | 2700K 48lm | 3000K 51lm | 4000K

Versione	Articolo	EUR
● cromo/smerigliato	1004970	181,00

1006672 469

1006623 475

1006834 471





NEW



NUMINOS® XS | 468



NEW



NUMINOS® S | 468



NEW



NUMINOS® XS | 470



NEW



NUMINOS® S | 470



NEW



IN-LINE 22 | 473



NEW



IN-LINE 22 | 473



NEW



IN-LINE 44 | 475



NEW



IN-LINE 44 | 475



NEW



IN-LINE 24 | 477



NEW



IN-LINE 46 | 477

1006623 + 1006617 475 + 473





BINARIO 48V STANDARD

Binario standard, montaggio in superficie,
parete/plafone, DALI

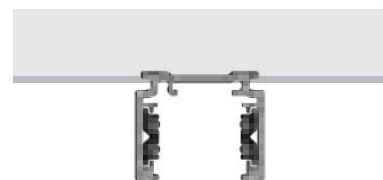

	1 m	1 m	2 m	2 m
Tensione nominale (V)	48V DC	48V DC	48V DC	48V DC
Intensità di corrente massima (A)	16	16	16	16
Carico meccanico massimo (Kg)	5 kg	5 kg	10 kg	10 kg
Colore	● nero	○ bianco	● nero	○ bianco
Materiale	Alluminio	Alluminio	Alluminio	Alluminio
L x P x A (cm)	100 x 2,62 x 2,26	100 x 2,62 x 2,26	200 x 2,62 x 2,26	200 x 2,62 x 2,26
Articolo	1006541 ●	1006542 ●	1006543 ●	1006544 ●
EUR	49,00	49,00	84,00	84,00
	3 m	3 m	4 m	4 m
Tensione nominale (V)	48V DC	48V DC	48V DC	48V DC
Intensità di corrente massima (A)	16	16	16	16
Carico meccanico massimo (Kg)	15 kg	15 kg	20 kg	20 kg
Colore	● nero	○ bianco	● nero	○ bianco
Materiale	Alluminio	Alluminio	Alluminio	Alluminio
L x P x A (cm)	300 x 2,62 x 2,26	300 x 2,62 x 2,26	400 x 2,62 x 2,26	400 x 2,62 x 2,26
Articolo	1006545 ●	1006546 ●	1006547 ●	1006548 ●
EUR	132,00	132,00	180,00	180,00



BINARIO 48V STANDARD

Binario standard, montaggio in superficie, parete/plafone, DALI
Guida alla progettazione e panoramica accessori

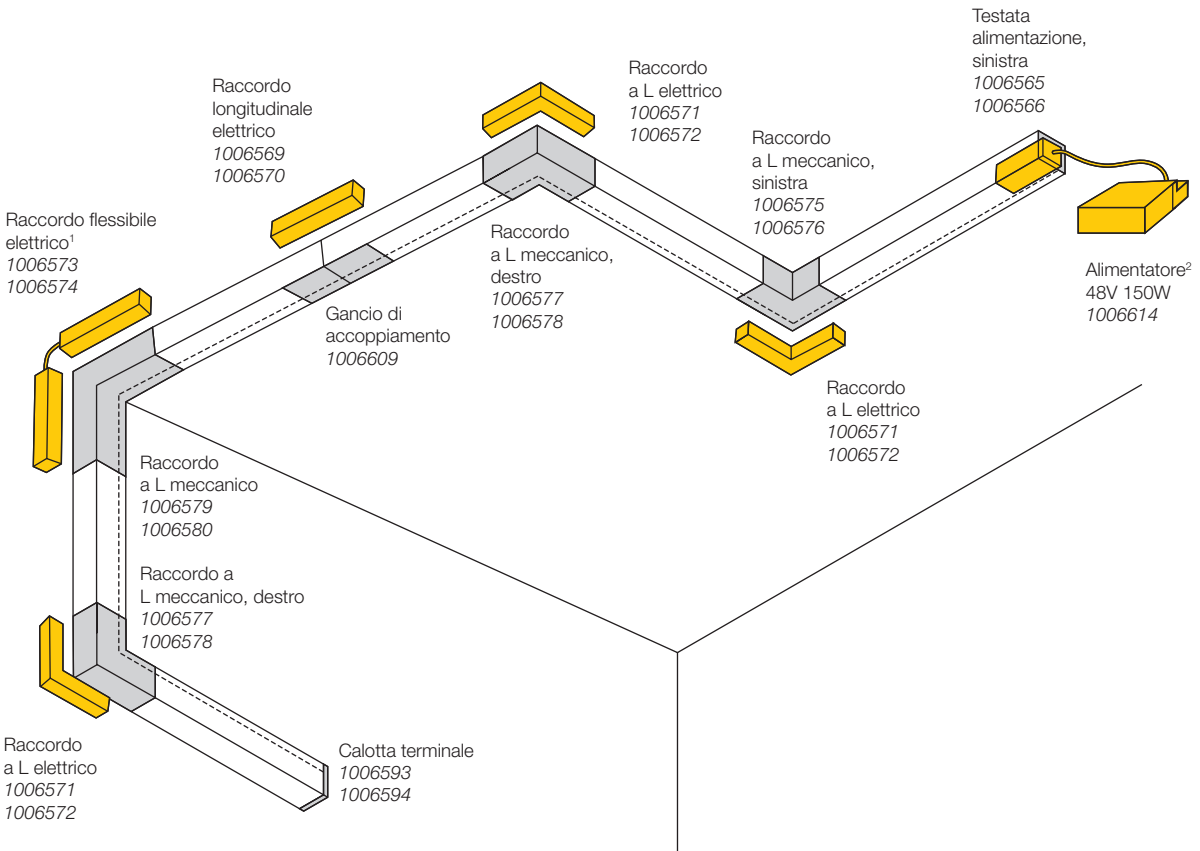

¹ Si prega di notare che i raccordi elettrici e meccanici devono sempre essere installati insieme

² L'alimentatore deve essere posizionato esternamente.



Testata alimentazione, destra
16A max. | Policarbonato (PC)
L: 9,7 cm | La: 1,6 cm | H: 1,9 cm

● nero Articolo **1006567** **14,00 EUR**
○ bianco **1006568** **14,00 EUR**

Alimentatore 60W | 48V
Policarbonato (PC)
L: 18 cm | La: 4,5 cm | H: 2,7 cm

○ bianco Articolo **1006613** **59,00 EUR**

Testata alimentazione, sinistra
16A max. | Policarbonato (PC)
L: 9,7 cm | La: 1,6 cm | H: 1,9 cm

● nero Articolo **1006565** **14,00 EUR**
○ bianco **1006566** **14,00 EUR**

Alimentatore 150W | 48V
Metallo / policarbonato (PC)
L: 19,05 cm | La: 8,8 cm | H: 3,55 cm

● nero Articolo **1006614** **129,00 EUR**

Raccordo a L meccanico, per binario standard, destra
Alluminio
L: 7,1 cm | La: 7,1 cm | H: 2,19 cm

● nero Articolo **1006577** **21,00 EUR**
○ bianco **1006578** **21,00 EUR**

Copertura, 20 mm per binario standard, 2 m
Alluminio/policarbonato (PC)
L: 200 cm | La: 2 cm | H: 0,6 cm

● nero Articolo **1006611** **9,90 EUR**
○ bianco **1006612** **9,90 EUR**

Raccordo a L meccanico, per binario standard, sinistra
Alluminio
L: 7,1 cm | La: 7,1 cm | H: 2,19 cm

● nero Articolo **1006575** **21,00 EUR**
○ bianco **1006576** **21,00 EUR**

Calotta di chiusura per binario standard
Policarbonato (PC)
L: 2,6 cm | La: 0,2 cm | H: 2,2 cm

● nero Articolo **1006593** **3,50 EUR**
○ bianco **1006594** **3,50 EUR**

Raccordo a L meccanico, per binario standard, passaggio da parete a plafone
Alluminio
L: 8,4 cm | La: 2,62 cm | H: 8,4 cm

● nero Articolo **1006579** **21,00 EUR**
○ bianco **1006580** **21,00 EUR**

Piastra di accoppiamento per binario standard e binario profilo alto
Acciaio
L: 5 cm | La: 1,32 cm | H: 0,25 cm

● grigio Articolo **1006609** **8,80 EUR**

Raccordo L elettrico, DALI
16A max. | Policarbonato (PC)
L: 11,4 cm | La: 11,4 cm | H: 1,9 cm

● nero Articolo **1006571** **27,00 EUR**
○ bianco **1006572** **27,00 EUR**

Set cavo di sospensione 3 m con piastra di accoppiamento
Acciaio
L: 12 cm | La: 2,7 cm

● nero Articolo **1006603** **21,00 EUR**
○ bianco **1006604** **21,00 EUR**

Raccordo lineare elettrico, DALI
16A max. | Policarbonato (PC)
L: 14,4 cm | La: 1,6 cm | H: 1,9 cm

● nero Articolo **1006569** **21,00 EUR**
○ bianco **1006570** **21,00 EUR**

Set barra di sospensione 1 m con piastra di accoppiamento
Acciaio
L: 12 cm | La: 2,7 cm

● nero Articolo **1006601** **21,00 EUR**
○ bianco **1006602** **21,00 EUR**

Raccordo flessibile elettrico, DALI
16A max. | Policarbonato (PC)
L: 23 cm | La: 1,6 cm | H: 1,9 cm

● nero Articolo **1006573** **29,00 EUR**
○ bianco **1006574** **29,00 EUR**

Barra di sospensione, 1 m
Acciaio
La: 2,9 cm

● nero Articolo **1006605** **18,00 EUR**
○ bianco **1006606** **18,00 EUR**

Box alloggiamento trasformatore inclusa testata di alimentazione destra, DALI
Policarbonato (PC)
L: 23,3 cm | La: 10,1 cm | H: 4,1 cm

● nero Articolo **1007137** **35,00 EUR**
○ bianco **1007138** **35,00 EUR**

Cavo di sospensione, 3 m
Acciaio
La: 2,9 cm

● nero Articolo **1006607** **18,00 EUR**
○ bianco **1006608** **18,00 EUR**

Box alloggiamento trasformatore inclusa testata di alimentazione sinistra, DALI
Policarbonato (PC)
L: 23,3 cm | La: 10,1 cm | H: 4,1 cm

● nero Articolo **1007083** **35,00 EUR**
○ bianco **1007084** **35,00 EUR**

Morsetto di fissaggio
Alluminio
L: 3 cm | La: 2,72 cm | H: 1,05 cm

● nero Articolo **1006599** **7,50 EUR**
○ bianco **1006600** **7,50 EUR**

1006726 + 1006623 + 1006617 469 + 475 + 473

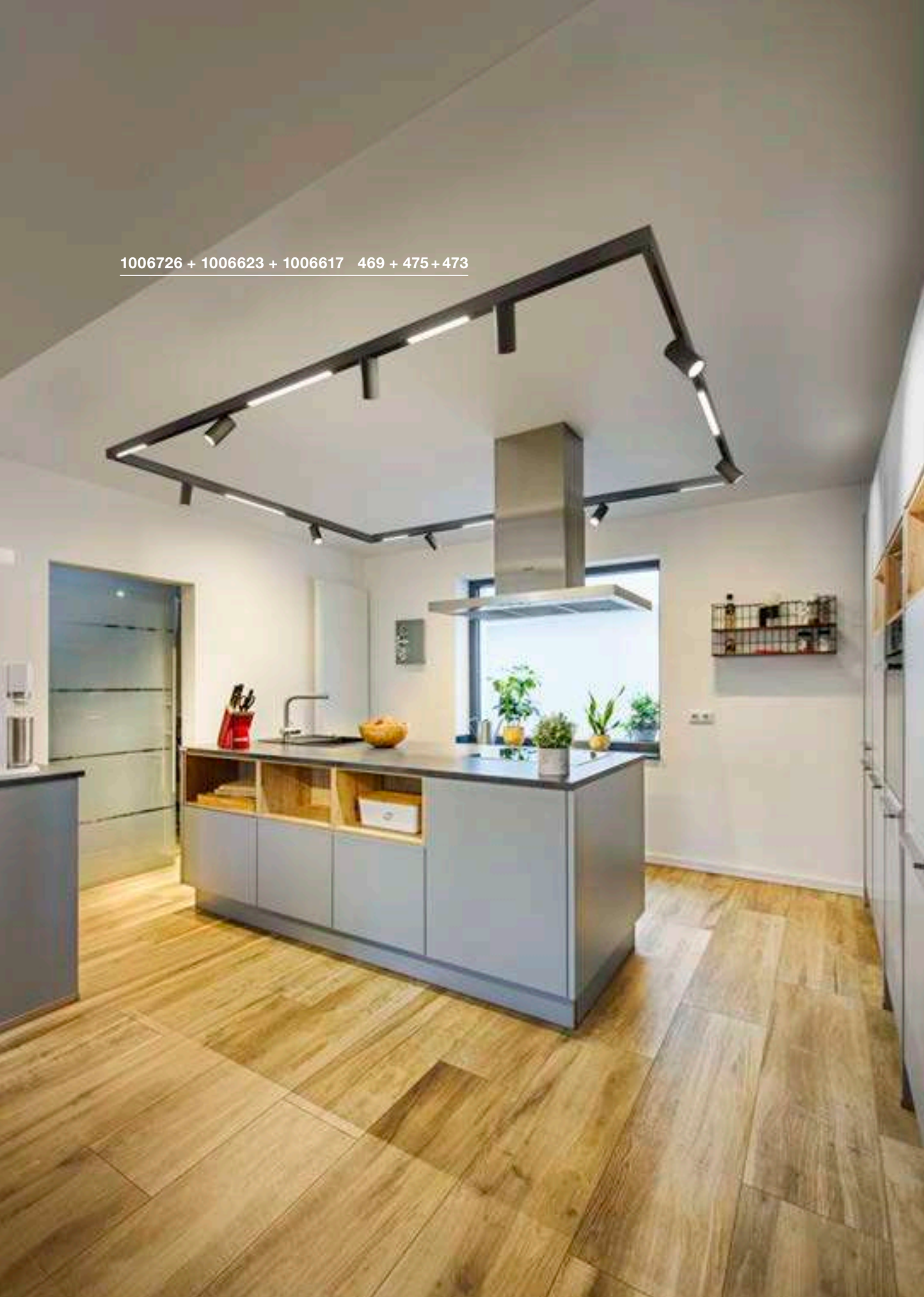



NEW

BINARIO 48V PROFILO ALTO

Binario profilo alto, montaggio in superficie,
parete/plafone, DALI

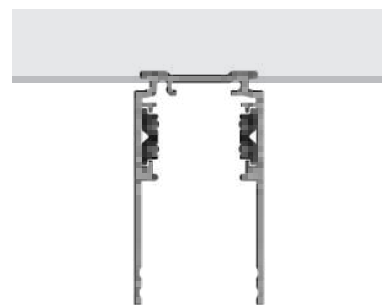

	1 m	1 m	2 m	2 m
Tensione nominale (V)	48V DC	48V DC	48V DC	48V DC
Intensità di corrente massima (A)	16	16	16	16
Carico meccanico massimo (Kg)	5 kg	5 kg	10 kg	10 kg
Colore	● nero	○ bianco	● nero	○ bianco
Materiale	Alluminio	Alluminio	Alluminio	Alluminio
L x P x A (cm)	100 x 2,62 x 4,72	100 x 2,62 x 4,72	200 x 2,62 x 4,72	200 x 2,62 x 4,72
Articolo	1006549 ●	1006550 ●	1006551 ●	1006552 ●
EUR	59,00	59,00	115,00	115,00
	3 m	3 m	4 m	4 m
Tensione nominale (V)	48V DC	48V DC	48V DC	48V DC
Intensità di corrente massima (A)	16	16	16	16
Carico meccanico massimo (Kg)	15 kg	15 kg	20 kg	20 kg
Colore	● nero	○ bianco	● nero	○ bianco
Materiale	Alluminio	Alluminio	Alluminio	Alluminio
L x P x A (cm)	300 x 2,62 x 4,72	300 x 2,62 x 4,72	400 x 2,62 x 4,72	400 x 2,62 x 4,72
Articolo	1006553 ●	1006554 ●	1006555 ●	1006556 ●
EUR	170,00	170,00	228,00	228,00



BINARIO 48V PROFILO ALTO

Binario profilo, montaggio in superficie, parete/plafone, DALI
Guida alla progettazione e panoramica accessori

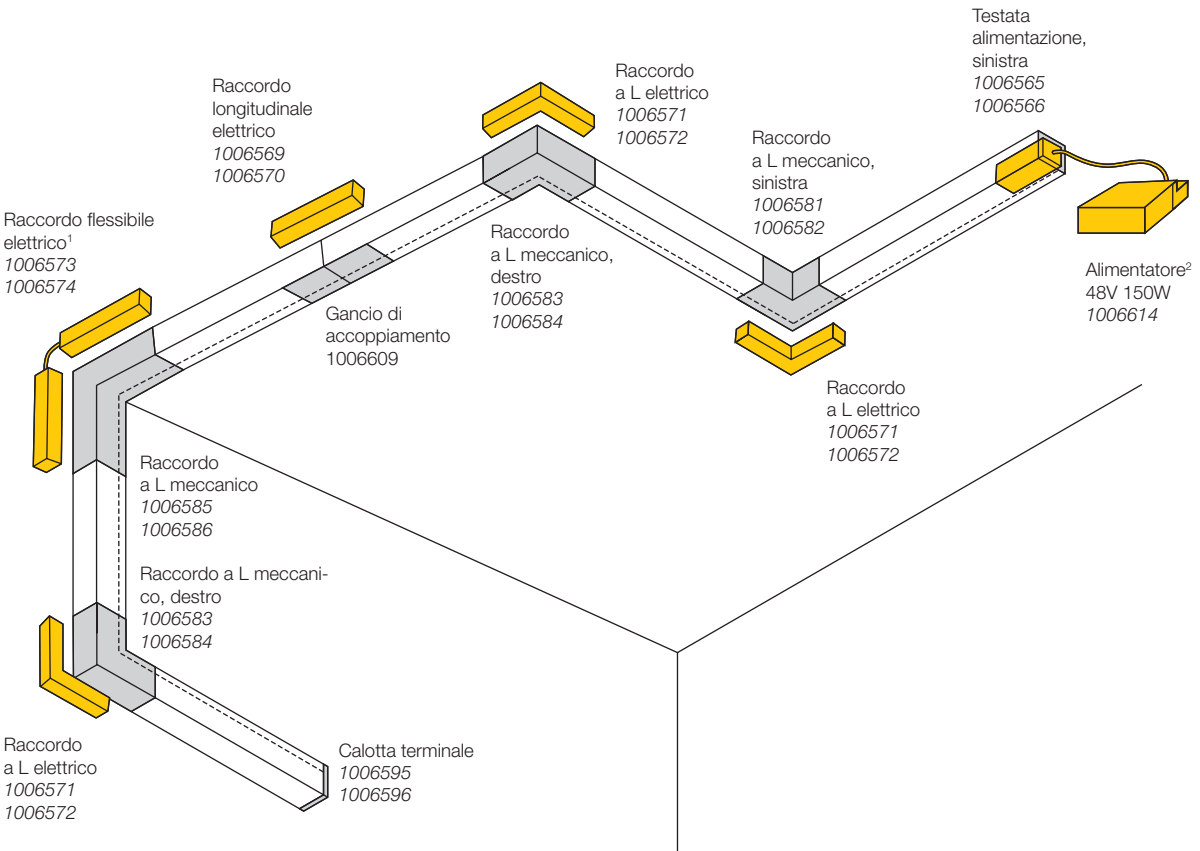

¹ Si prega di notare che i raccordi elettrici e meccanici devono sempre essere installati insieme.

² L'alimentatore deve essere posizionato esternamente.



Testata alimentazione, destra
16A max. | Policarbonato (PC)
L: 9,7 cm | La: 1,6 cm | H: 1,9 cm

● nero Articolo **1006567** **14,00 EUR**
○ bianco **1006568** **14,00 EUR**

Alimentatore 60W | 48V
Policarbonato (PC)
L: 18 cm | La: 4,5 cm | H: 2,7 cm

○ bianco Articolo **1006613** **59,00 EUR**

Testata alimentazione, sinistra
16A max. | Policarbonato (PC)
L: 9,7 cm | La: 1,6 cm | H: 1,9 cm

● nero Articolo **1006565** **14,00 EUR**
○ bianco **1006566** **14,00 EUR**

Alimentatore 150W | 48V
Metallo / policarbonato (PC)
L: 19,05 cm | La: 8,8 cm | H: 3,55 cm

● nero Articolo **1006614** **129,00 EUR**

Raccordo a L meccanico, per binario profilo alto, destra
Alluminio
L: 7,1 cm | La: 7,1 cm | H: 4,7 cm

● nero Articolo **1006583** **29,00 EUR**
○ bianco **1006584** **29,00 EUR**

Copertura 26 mm, per binario profilo alto e binario da incasso, 2 m
Policarbonato (PC)
L: 200 cm | B: 26 cm | H: 6 cm

● nero Articolo **1007188** **12,00 EUR**
○ bianco **1007189** **12,00 EUR**

Raccordo a L meccanico, per binario profilo alto, sinistra
Alluminio
L: 7,1 cm | La: 7,1 cm | H: 4,7 cm

● nero Articolo **1006581** **29,00 EUR**
○ bianco **1006582** **29,00 EUR**

Calotta di chiusura per binario profilo alto
Policarbonato (PC)
L: 2,6 cm | La: 0,2 cm | H: 4,7 cm

● nero Articolo **1006595** **6,50 EUR**
○ bianco **1006596** **6,50 EUR**

Raccordo a L meccanico, per binario profilo alto, passaggio da parete a plafone
Alluminio
L: 8,4 cm | La: 8,4 cm | H: 4,7 cm

● nero Articolo **1006585** **29,00 EUR**
○ bianco **1006586** **29,00 EUR**

Piastra di accoppiamento per binario standard e binario profilo alto
Acciaio
L: 5 cm | La: 1,32 cm | H: 0,25 cm

● grigio Articolo **1006609** **8,80 EUR**

Raccordo L elettrico, DALI
16A max. | Policarbonato (PC)
L: 11,4 cm | La: 11,4 cm | H: 1,9 cm

● nero Articolo **1006571** **27,00 EUR**
○ bianco **1006572** **27,00 EUR**

Set cavo di sospensione 3 m con piastra di accoppiamento
Acciaio
L: 12 cm | La: 2,7 cm

● nero Articolo **1006603** **21,00 EUR**
○ bianco **1006604** **21,00 EUR**

Raccordo lineare elettrico, DALI
16A max. | Policarbonato (PC)
L: 14,4 cm | La: 1,6 cm | H: 1,9 cm

● nero Articolo **1006569** **21,00 EUR**
○ bianco **1006570** **21,00 EUR**

Set barra di sospensione 1 m con piastra di accoppiamento
Acciaio
L: 12 cm | La: 2,7 cm

● nero Articolo **1006601** **21,00 EUR**
○ bianco **1006602** **21,00 EUR**

Raccordo flessibile elettrico, DALI
16A max. | Policarbonato (PC)
L: 23 cm | La: 1,6 cm | H: 1,9 cm

● nero Articolo **1006573** **29,00 EUR**
○ bianco **1006574** **29,00 EUR**

Barra di sospensione, 1 m
Acciaio
La: 2,9 cm

● nero Articolo **1006605** **18,00 EUR**
○ bianco **1006606** **18,00 EUR**

Box alloggiamento trasformatore inclusa testata di alimentazione destra, DALI
Policarbonato (PC)
L: 23,3 cm | La: 10,1 cm | H: 4,1 cm

● nero Articolo **1007137** **35,00 EUR**
○ bianco **1007138** **35,00 EUR**

Cavo di sospensione, 3 m
Acciaio
La: 2,9 cm

● nero Articolo **1006607** **18,00 EUR**
○ bianco **1006608** **18,00 EUR**

Box alloggiamento trasformatore inclusa testata di alimentazione sinistra, DALI
Policarbonato (PC)
L: 23,3 cm | La: 10,1 cm | H: 4,1 cm

● nero Articolo **1007083** **35,00 EUR**
○ bianco **1007084** **35,00 EUR**

Morsetto di fissaggio
Alluminio
L: 3 cm | La: 2,72 cm | H: 1,05 cm

● nero Articolo **1006599** **7,50 EUR**
○ bianco **1006600** **7,50 EUR**

1006783 + 1006672 + 1006635 471 + 471 + 475

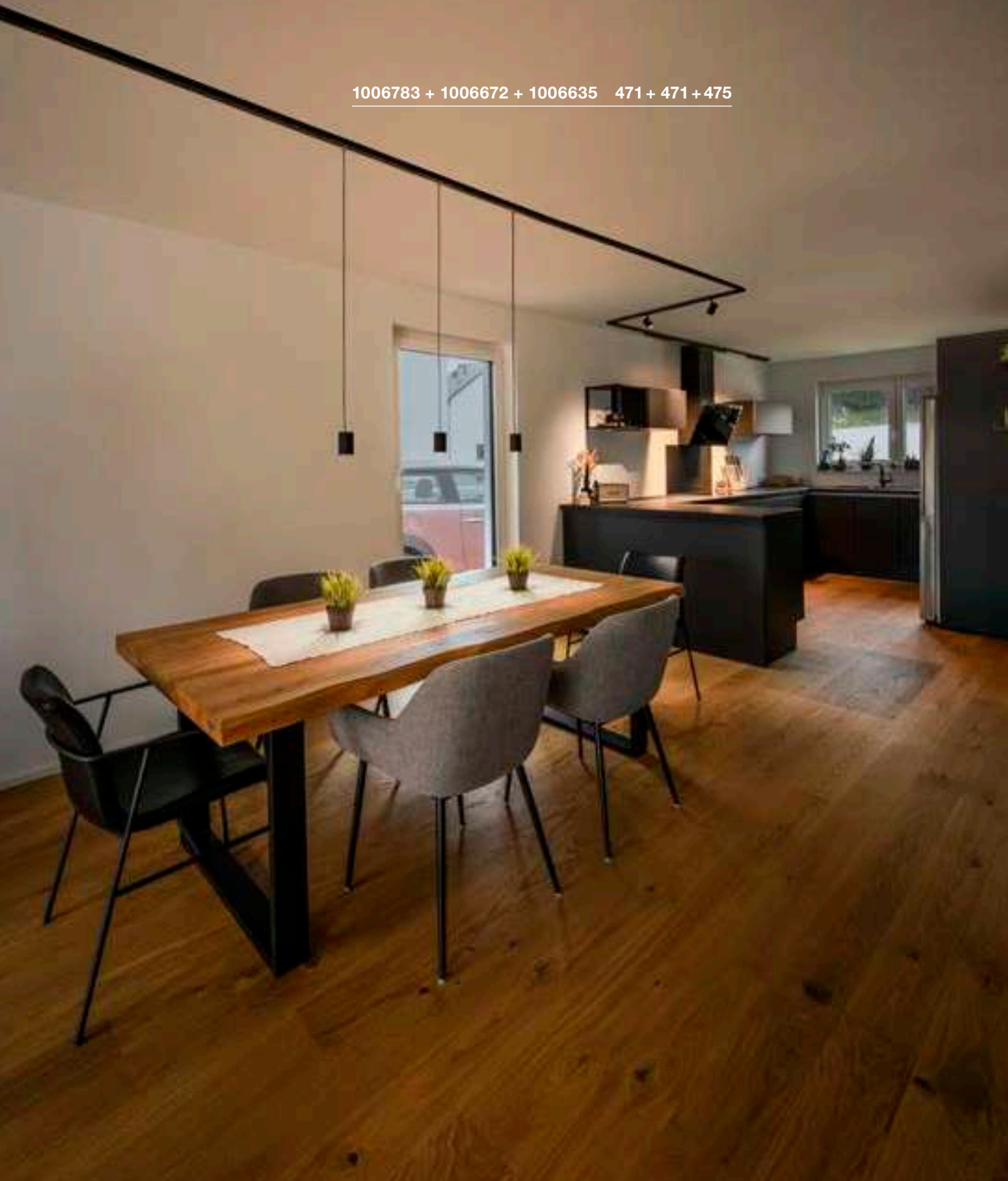



NEW

BINARIO 48V INCASSO

Binario da incasso, parete/plafone, DALI

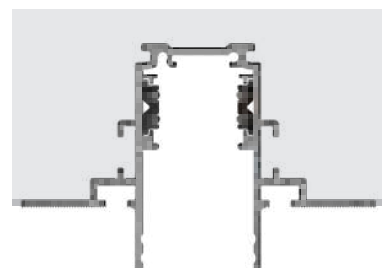

	1 m	1 m	2 m	2 m
Tensione nominale (V)	48V DC	48V DC	48V DC	48V DC
Intensità di corrente massima (A)	16	16	16	16
Carico meccanico massimo (Kg)	5 kg	5 kg	10 kg	10 kg
Colore	● nero	○ bianco	● nero	○ bianco
Materiale	Alluminio	Alluminio	Alluminio	Alluminio
L x P x A (cm)	100 x 7,4 x 4,7	100 x 7,4 x 4,7	200 x 7,4 x 4,7	200 x 7,4 x 4,7
Articolo	1006557 ●	1006558 ●	1006559 ●	1006560 ●
EUR	79,00	79,00	138,00	138,00
	3 m	3 m	4 m	4 m
Tensione nominale (V)	48V DC	48V DC	48V DC	48V DC
Intensità di corrente massima (A)	16	16	16	16
Carico meccanico massimo (Kg)	15 kg	15 kg	20 kg	20 kg
Colore	● nero	○ bianco	● nero	○ bianco
Materiale	Alluminio	Alluminio	Alluminio	Alluminio
L x P x A (cm)	300 x 7,4 x 4,7	300 x 7,4 x 4,7	400 x 7,4 x 4,7	400 x 7,4 x 4,7
Articolo	1006561 ●	1006562 ●	1006563 ●	1006564 ●
EUR	178,00	178,00	256,00	256,00



BINARIO 48V INCASSO

Binario da incasso, parete/plafone, DALI
Guida alla progettazione e panoramica accessori

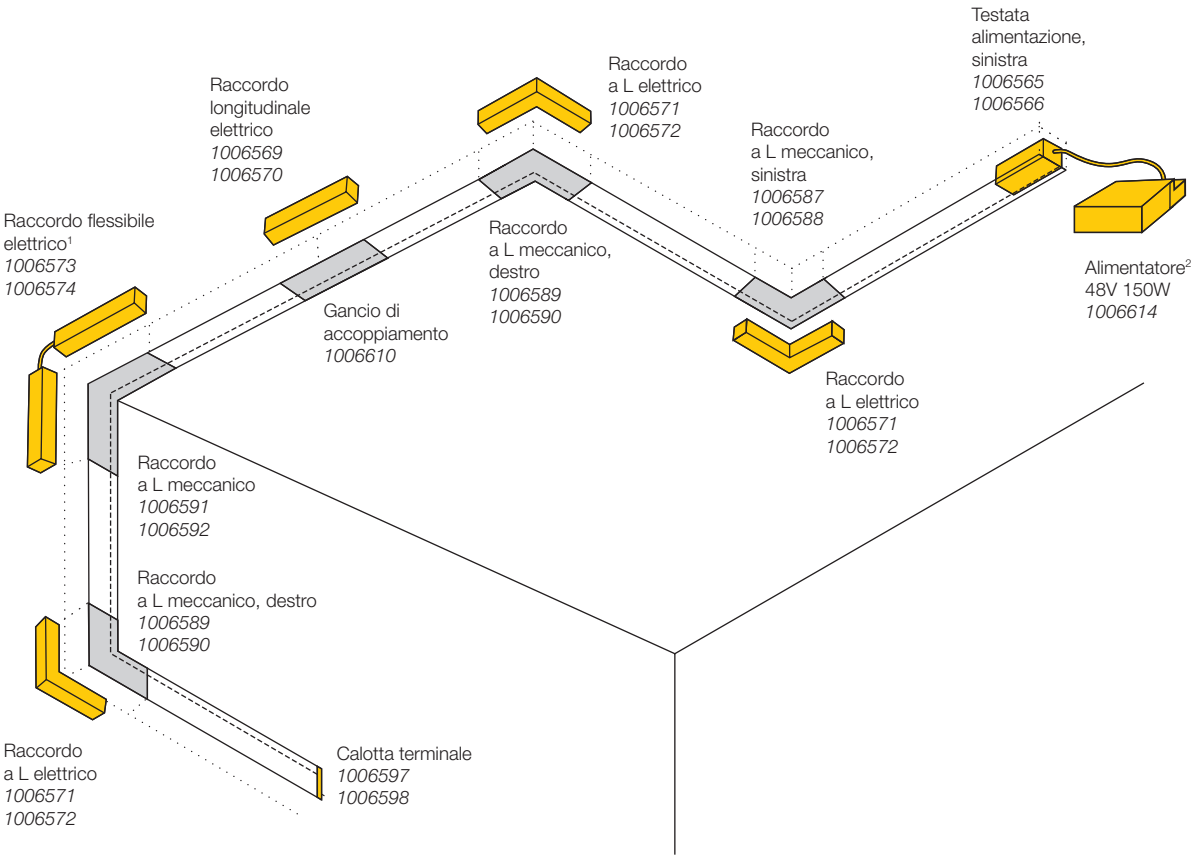

¹ Si prega di notare che i raccordi elettrici e meccanici devono sempre essere installati insieme.

² L'alimentatore deve essere posizionato esternamente.

**Testata alimentazione, destra**16A max. | Policarbonato (PC)
L: 9,7 cm | La: 1,6 cm | H: 1,9 cm● nero Articolo 1006567 14,00 EUR
○ bianco Articolo 1006568 14,00 EUR**Alimentatore 60W | 48V**Policarbonato (PC)
L: 18 cm | La: 4,5 cm | H: 2,7 cm

○ bianco Articolo 1006613 59,00 EUR

Testata alimentazione, sinistra16A max. | Policarbonato (PC)
L: 9,7 cm | La: 1,6 cm | H: 1,9 cm● nero Articolo 1006565 14,00 EUR
○ bianco Articolo 1006566 14,00 EUR**Alimentatore 150W | 48V**Metallo / policarbonato (PC)
L: 19,05 cm | La: 8,8 cm | H: 3,55 cm

● nero Articolo 1006614 129,00 EUR

Raccordo a L meccanico, per binario incasso, destraAlluminio
L: 9,5 cm | La: 9,5 cm | H: 4,7 cm● nero Articolo 1006589 32,00 EUR
○ bianco Articolo 1006590 32,00 EUR**Copertura 26 mm, per binario profilo alto e binario da incasso, 2 m**Policarbonato (PC)
L: 200 cm | B: 26 cm | H: 6 cm● nero Articolo 1007188 12,00 EUR
○ bianco Articolo 1007189 12,00 EUR**Raccordo a L meccanico, per binario incasso, sinistra**Alluminio
L: 9,5 cm | La: 9,5 cm | H: 4,7 cm● nero Articolo 1006587 32,00 EUR
○ bianco Articolo 1006588 32,00 EUR**Calotta di chiusura per binario da incasso**Policarbonato (PC)
L: 3,4 cm | La: 0,2 cm | H: 4,7 cm● nero Articolo 1006597 3,50 EUR
○ bianco Articolo 1006598 3,50 EUR**Raccordo a L meccanico, per binario incasso, passaggio da parete a plafone**Alluminio
L: 8,1 cm | B: 7,4 cm | H: 8,1 cm● nero Articolo 1006591 32,00 EUR
○ bianco Articolo 1006592 32,00 EUR**Set piastre di accoppiamento per binario da incasso**Acciaio
L: 6,3 cm | La: 0,76 cm | H: 0,25 cm

● grigio Articolo 1006610 8,80 EUR

Raccordo L elettrico, DALI16A max. | Policarbonato (PC)
L: 11,4 cm | La: 11,4 cm | H: 1,9 cm● nero Articolo 1006571 27,00 EUR
○ bianco Articolo 1006572 27,00 EUR**Set cavo di sospensione 3 m con piastra di accoppiamento**Acciaio
L: 12 cm | La: 2,7 cm● nero Articolo 1006603 21,00 EUR
○ bianco Articolo 1006604 21,00 EUR**Raccordo lineare elettrico, DALI**16A max. | Policarbonato (PC)
L: 14,4 cm | La: 1,6 cm | H: 1,9 cm● nero Articolo 1006569 21,00 EUR
○ bianco Articolo 1006570 21,00 EUR**Set barra di sospensione 1 m con piastra di accoppiamento**Acciaio
L: 12 cm | La: 2,7 cm● nero Articolo 1006601 21,00 EUR
○ bianco Articolo 1006602 21,00 EUR**Raccordo flessibile elettrico, DALI**16A max. | Policarbonato (PC)
L: 23 cm | La: 1,6 cm | H: 1,9 cm● nero Articolo 1006573 29,00 EUR
○ bianco Articolo 1006574 29,00 EUR**Barra di sospensione, 1 m**Acciaio
La: 2,9 cm● nero Articolo 1006605 18,00 EUR
○ bianco Articolo 1006606 18,00 EUR**Box alloggiamento trasformatore inclusa testata di alimentazione destra, DALI**Policarbonato (PC)
L: 23,3 cm | La: 10,1 cm | H: 4,1 cm● nero Articolo 1007137 35,00 EUR
○ bianco Articolo 1007138 35,00 EUR**Cavo di sospensione, 3 m**Acciaio
La: 2,9 cm● nero Articolo 1006607 18,00 EUR
○ bianco Articolo 1006608 18,00 EUR**Box alloggiamento trasformatore inclusa testata di alimentazione sinistra, DALI**Policarbonato (PC)
L: 23,3 cm | La: 10,1 cm | H: 4,1 cm● nero Articolo 1007083 35,00 EUR
○ bianco Articolo 1007084 35,00 EUR**Morsetto di fissaggio**Alluminio
L: 3 cm | La: 2,72 cm | H: 1,05 cm● nero Articolo 1006599 7,50 EUR
○ bianco Articolo 1006600 7,50 EUR

1006635 + 1006729 475 + 469

NUMINOS® XS
48V, DALI

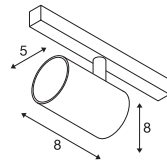
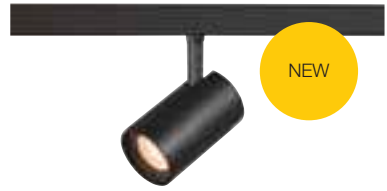

NUMINOS® S
48V, DALI

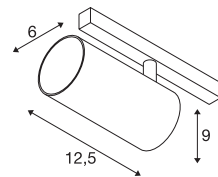



NUMINOS® SPOT 48V



XS 48V | 200mA
Potenza assorbita: 8,7W
Materiale: alluminio/polycarbonato (PC)

S 48V | 350mA
Potenza assorbita: 16W
Materiale: alluminio/polycarbonato (PC)

		2700K	20°	640lm	1006651	175,00 EUR	100lm	1006705	185,00 EUR
			40°	620lm	1006654	175,00 EUR	970lm	1006708	185,00 EUR
			55°	640lm	1006657	175,00 EUR	960lm	1006711	185,00 EUR
		3000K	20°	700lm	1006669	175,00 EUR	1060lm	1006723	185,00 EUR
			40°	670lm	1006672	175,00 EUR	1030lm	1006726	185,00 EUR
			55°	690lm	1006675	175,00 EUR	1030lm	1006729	185,00 EUR
		2700K	20°	670lm	1006652	175,00 EUR	1020lm	1006706	185,00 EUR
			40°	650lm	1006655	175,00 EUR	1050lm	1006709	185,00 EUR
			55°	670lm	1006658	175,00 EUR	1030lm	1006712	185,00 EUR
		3000K	20°	730lm	1006670	175,00 EUR	1120lm	1006724	185,00 EUR
			40°	700lm	1006673	175,00 EUR	1120lm	1006727	185,00 EUR
			55°	720lm	1006676	175,00 EUR	1120lm	1006730	185,00 EUR
		2700K	20°	670lm	1006653	175,00 EUR	960lm	1006707	185,00 EUR
			40°	650lm	1006656	175,00 EUR	1000lm	1006710	185,00 EUR
			55°	670lm	1006659	175,00 EUR	980lm	1006713	185,00 EUR
		3000K	20°	730lm	1006671	175,00 EUR	1050lm	1006725	185,00 EUR
			40°	700lm	1006674	175,00 EUR	1050lm	1006728	185,00 EUR
			55°	720lm	1006677	175,00 EUR	1050lm	1006731	185,00 EUR
		2700K	20°	670lm	1006661	175,00 EUR	1020lm	1006715	185,00 EUR
			40°	650lm	1006664	175,00 EUR	1050lm	1006718	185,00 EUR
			55°	670lm	1006667	175,00 EUR	1030lm	1006721	185,00 EUR
		3000K	20°	730lm	1006679	175,00 EUR	1120lm	1006733	185,00 EUR
			40°	700lm	1006682	175,00 EUR	1120lm	1006736	185,00 EUR
			55°	720lm	1006685	175,00 EUR	1120lm	1006739	185,00 EUR
		2700K	20°	640lm	1006660	175,00 EUR	1000lm	1006714	185,00 EUR
			40°	620lm	1006663	175,00 EUR	970lm	1006717	185,00 EUR
			55°	640lm	1006666	175,00 EUR	960lm	1006720	185,00 EUR
		3000K	20°	700lm	1006678	175,00 EUR	1060lm	1006732	185,00 EUR
			40°	670lm	1006681	175,00 EUR	1030lm	1006735	185,00 EUR
			55°	690lm	1006684	175,00 EUR	1030lm	1006738	185,00 EUR
		2700K	20°	670lm	1006662	175,00 EUR	960lm	1006716	185,00 EUR
			40°	650lm	1006665	175,00 EUR	1000lm	1006719	185,00 EUR
			55°	670lm	1006668	175,00 EUR	980lm	1006722	185,00 EUR
		3000K	20°	730lm	1006680	175,00 EUR	1050lm	1006734	185,00 EUR
			40°	700lm	1006683	175,00 EUR	1050lm	1006737	185,00 EUR
			55°	720lm	1006686	175,00 EUR	1050lm	1006740	185,00 EUR



Articolo	Articolo	EUR
Diffusore ellittico XS		
● trasparente	1005612	4,50
Diffusore prismatico XS		
● trasparente	1005613	5,30
Diffusore smerigliato XS		
○ smerigliato	1005614	5,30
Diffusore a nido d'ape XS		
● nero	1005615	8,35



Articolo	Articolo	EUR
Diffusore ellittico S		
● trasparente	1004786	4,50
Diffusore prismatico S		
● trasparente	1004787	5,30
Diffusore smerigliato S		
○ smerigliato	1004788	5,30
Diffusore a nido d'ape S		
● nero	1004789	8,35

Questi apparecchi sono disponibili su richiesta anche nelle versioni 4000K (escluso XS). In questo caso i tempi di consegna e i quantitativi minimi d'ordine sono differenti.

1006844 471

NUMINOS® XS
48V, DALI

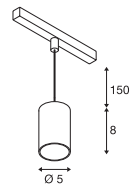

NUMINOS® S
48V, DALI

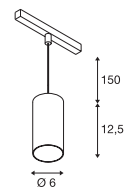



NUMINOS® SOSPENSIONE 48V

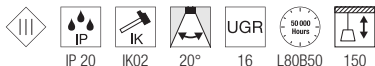

XS 48V | 200mA
Potenza assorbita: 8,7W
Materiale: alluminio/polycarbonato (PC)

S 48V | 350mA
Potenza assorbita: 16W
Materiale: alluminio/polycarbonato (PC)

	2700K	20°	460lm	1006759	195,00 EUR	
		40°	620lm	1006762	195,00 EUR	
		55°	640lm	1006765	195,00 EUR	
	3000K	20°	700lm	1006777	195,00 EUR	
		40°	670lm	1006780	195,00 EUR	
		55°	690lm	1006783	195,00 EUR	
		2700K	20°	670lm	1006760	195,00 EUR
			40°	650lm	1006763	195,00 EUR
			55°	670lm	1006766	195,00 EUR
3000K		20°	730lm	1006778	195,00 EUR	
		40°	700lm	1006781	195,00 EUR	
		55°	720lm	1006784	195,00 EUR	
		2700K	20°	670lm	1006761	195,00 EUR
			40°	650lm	1006764	195,00 EUR
			55°	670lm	1006767	195,00 EUR
	3000K	20°	730lm	1006779	195,00 EUR	
		40°	700lm	1006782	195,00 EUR	
		55°	720lm	1006785	195,00 EUR	
		2700K	20°	670lm	1006769	195,00 EUR
			40°	650lm	1006772	195,00 EUR
			55°	670lm	1006775	195,00 EUR
3000K		20°	730lm	1006787	195,00 EUR	
		40°	700lm	1006790	195,00 EUR	
		55°	720lm	1006793	195,00 EUR	
		2700K	20°	620lm	1006771	195,00 EUR
			40°	640lm	1006768	195,00 EUR
			55°	640lm	1006774	195,00 EUR
	3000K	20°	700lm	1006786	195,00 EUR	
		40°	670lm	1006789	195,00 EUR	
		55°	690lm	1006792	195,00 EUR	
		2700K	20°	670lm	1006770	195,00 EUR
			40°	650lm	1006773	195,00 EUR
			55°	670lm	1006776	195,00 EUR
3000K		20°	730lm	1006788	195,00 EUR	
		40°	700lm	1006791	195,00 EUR	
		55°	720lm	1006794	195,00 EUR	

1000lm	1006813	205,00 EUR
970lm	1006816	205,00 EUR
960lm	1006819	205,00 EUR
1060lm	1006831	205,00 EUR
1030lm	1006834	205,00 EUR
1030lm	1006837	205,00 EUR
1020lm	1006814	205,00 EUR
1050lm	1006817	205,00 EUR
1030lm	1006820	205,00 EUR
1120lm	1006832	205,00 EUR
1120lm	1006835	205,00 EUR
1120lm	1006838	205,00 EUR
960lm	1006815	205,00 EUR
1000lm	1006818	205,00 EUR
980lm	1006821	205,00 EUR
1050lm	1006833	205,00 EUR
1050lm	1006836	205,00 EUR
1050lm	1006839	205,00 EUR
1020lm	1006823	205,00 EUR
1050lm	1006826	205,00 EUR
1030lm	1006829	205,00 EUR
1120lm	1006841	205,00 EUR
1120lm	1006844	205,00 EUR
1120lm	1006847	205,00 EUR
1000lm	1006822	205,00 EUR
970lm	1006825	205,00 EUR
960lm	1006828	205,00 EUR
1060lm	1006840	205,00 EUR
1030lm	1006843	205,00 EUR
1030lm	1006846	205,00 EUR
960lm	1006824	205,00 EUR
1000lm	1006827	205,00 EUR
980lm	1006830	205,00 EUR
1050lm	1006842	205,00 EUR
1050lm	1006845	205,00 EUR
1050lm	1006848	205,00 EUR



Articolo	Articolo	EUR
Diffusore ellittico XS		
● trasparente	1005612	4,50
Diffusore prismatico XS		
● trasparente	1005613	5,30
Diffusore smerigliato XS		
○ smerigliato	1005614	5,30
Diffusore a nido d'ape XS		
● nero	1005615	8,35



Articolo	Articolo	EUR
Diffusore ellittico S		
● trasparente	1004786	4,50
Diffusore prismatico S		
● trasparente	1004787	5,30
Diffusore smerigliato S		
○ smerigliato	1004788	5,30
Diffusore a nido d'ape S		
● nero	1004789	8,35

Questi apparecchi sono disponibili su richiesta anche nelle versioni 4000K (escluso XS). In questo caso i tempi di consegna e i quantitativi minimi d'ordine sono differenti.

1006654 + 1006633 + 1006627 469 + 475 + 473





IN-LINE 22 48V, opal, DALI



NEW

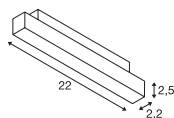

48V | 350mA
Potenza: 6W
Potenza assorbita: 7,3W
Materiale: alluminio



Down 540lm | 2700K
570lm | 3000K

Versione	Articolo	EUR
● nero 540lm 2700K	1006615	125,00
● nero 570lm 3000K	1006617	125,00
○ bianco 540lm 2700K	1006616	125,00
○ bianco 570lm 3000K	1006618	125,00

IN-LINE 22 48V, Darklight Reflector, DALI



NEW

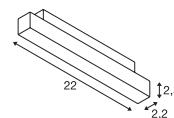

48V | 350mA
Potenza: 6W
Potenza assorbita: 7,3W
Materiale: alluminio/policarbonato (PC)



Down 580lm | 2700K
610lm | 3000K

Versione	Articolo	EUR
● nero 580lm 2700K	1006627	140,00
● nero 610lm 3000K	1006629	140,00
○ bianco 580lm 2700K	1006628	140,00
○ bianco 610lm 3000K	1006630	140,00



[1006633](tel:1006633) + [1006654](tel:1006654) [475+469](tel:475469)





IN-LINE 44
48V, opal, DALI



NEW

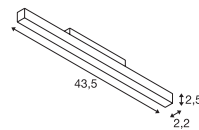
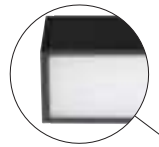

48V | 350mA
Potenza: 12W
Potenza assorbita: 14W
Materiale: alluminio/policarbonato (PC)



Down 1140lm | 2700K
1180lm | 3000K

Versione	Articolo	EUR
● nero 1140lm 2700K	1006621	184,00
● nero 1180lm 3000K	1006623	184,00
○ bianco 1140lm 2700K	1006622	184,00
○ bianco 1180lm 3000K	1006624	184,00

IN-LINE 44
48V, Darklight Reflector, DALI



NEW

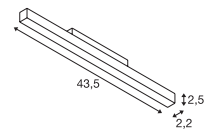

48V | 350mA
Potenza: 12W
Potenza assorbita: 14W
Materiale: alluminio



Down 1180lm | 2700K
1230lm | 3000K

Versione	Articolo	EUR
● nero 1180lm 2700K	1006633	199,00
● nero 1230lm 3000K	1006635	199,00
○ bianco 1180lm 2700K	1006634	199,00
○ bianco 1230lm 3000K	1006636	199,00

1006682 + 1006648 469 + 477

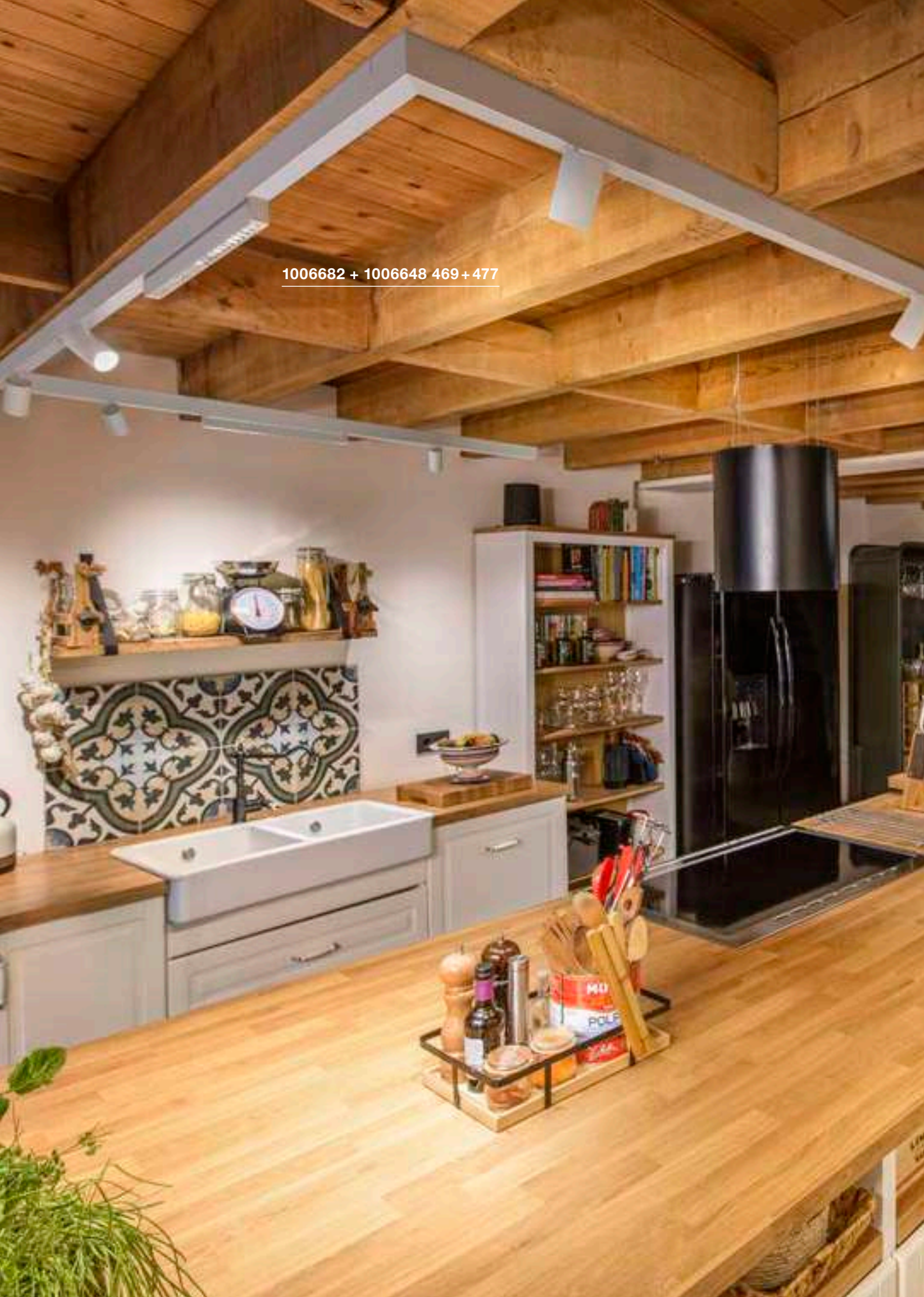



IN-LINE 24
48V, Move, Darklight Reflector, DALI



NEW

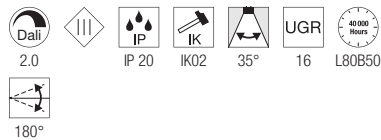
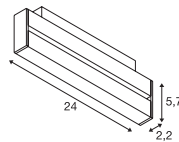
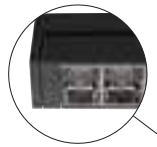

48V | 350mA
Potenza: 6W
Potenza assorbita: 7,3W
Materiale: alluminio/policarbonato (PC)



Down 580lm | 2700K
610lm | 3000K

Versione	Articolo	EUR
● nero		
580lm 2700K	1006639	150,00
● nero		
610lm 3000K	1006641	150,00
○ bianco		
580lm 2700K	1006640	150,00
○ bianco		
610lm 3000K	1006642	150,00

IN-LINE 46
48V, Move, Darklight Reflector, DALI



NEW

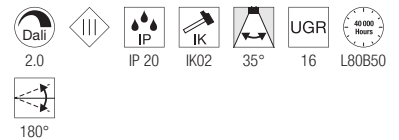
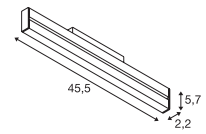

48V | 350mA
Potenza: 12W
Potenza assorbita: 14W
Materiale: alluminio/policarbonato (PC)



Down 1180lm | 2700K
1230lm | 3000K

Versione	Articolo	EUR
● nero		
1180lm 2700K	1006645	209,00
● nero		
1230lm 3000K	1006647	209,00
○ bianco		
1180lm 2700K	1006646	209,00
○ bianco		
1230lm 3000K	1006648	209,00

CONFUGURA IL TUO SISTEMA A 48V

Scegli il binario della lunghezza appropriata, del colore desiderato e del tipo di montaggio preferito. Seleziona la variante a incasso o una delle due possibilità di installazione in superficie. Con gli apparecchi NUMINOS® e IN-LINE appositamente concepiti per il sistema a 48V SLV, disporrai della massima flessibilità per poter regalare ai tuoi ambienti il risalto che meritano.

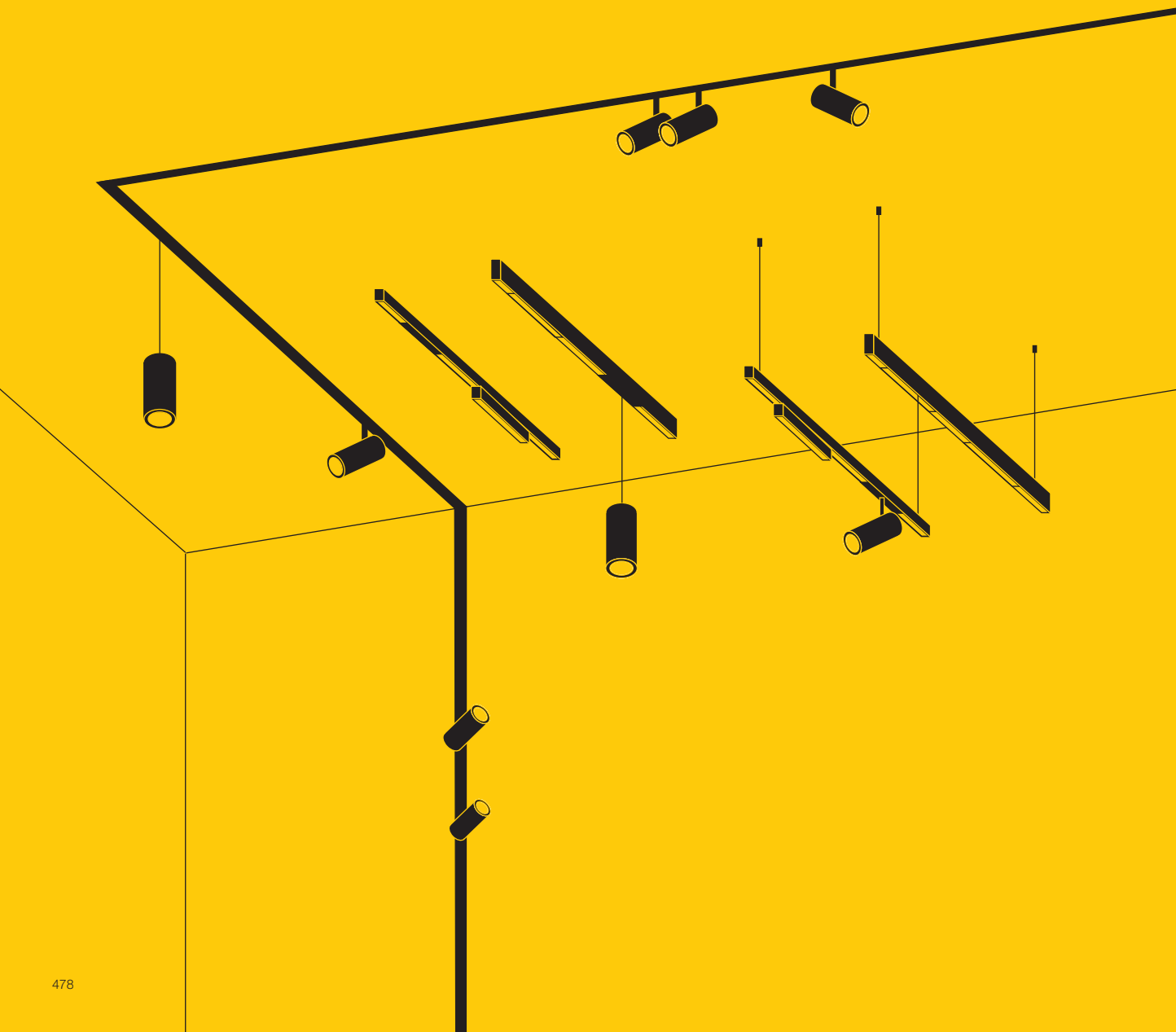

SCEGLI IL BINARIO

BINARIO STANDARD

BINARIO A PROFILO ALTO

BINARIO DA INCASSO

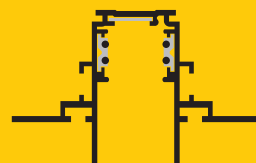
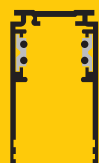

SCEGLI LA TIPOLOGIA DI INSTALLAZIONE

SUPERFICIE

INCASSO



Plafone



Parete



Sospensione



Plafone



Parete



SCEGLI GLI APPARECCHI

NUMINOS®
SPOT E SOSPENSIONE

IN-LINE, IN-LINE DARKLIGHT REFLECTOR
E IN-LINE MOVE



SCEGLI GLI ACCESSORI

RACCORDI, COPERTURE, KIT DI SOSPENSIONE, ALIMENTATORI, ECC.

139100 489





SCKET

ASMARA | 486



SCKET

TELESKOP | 486



SCKET

COSMIC | 487



SCKET

SYROS | 489



SCKET

SALUNA | 489



LED

DURNO | 489



LED

PLYTTA | 490



LED

NOBLO® SPOT | 491



LED

COMET LED | 491



SCKET

COMET | 491

TENSEO, Cavo a bassa tensione 4 mm², 10 m



	10 m	10 m	10 m
Tensione massima (V)	48	48	48
Corrente massima (A)	25	25	25
Colore	● nero	○ bianco	○ trasparente
Materiale	Rame/plastica	Rame/plastica	Rame/plastica
Diametro (cm)/Lunghezza (cm)	0,4 / 1000	0,4 / 1000	0,4 / 1000
Articolo	1002602	1002603	1002604
EUR	29,25	29,25	29,25

TENSEO, Cavo a bassa tensione 4 mm², 20 m



	20 m	20 m	20 m
Tensione massima (V)	48	48	48
Corrente massima (A)	25	25	25
Colore	● nero	○ bianco	○ trasparente
Materiale	Rame/plastica	Rame/plastica	Rame/plastica
Diametro (cm)/Lunghezza (cm)	0,4 / 2000	0,4 / 2000	0,4 / 2000
Articolo	139030	139031	139024
EUR	48,75	48,75	48,75



TENSEO, Cavo a bassa tensione 4 mm², 100 m



	100W	100W	100W
Tensione massima (V)	48	48	48
Corrente massima (A)	25	25	25
Colore	● nero	○ bianco	○ trasparente
Materiale	Rame/plastica	Rame/plastica	Rame/plastica
Diametro (cm)/Lunghezza (cm)	0,4 / 10000	0,4 / 10000	0,4 / 10000
Articolo	139040	139041	139004
EUR	244,00	244,00	244,00

TENSEO, Cavo a bassa tensione 6 mm², 20 m



	20 m	20 m	20 m
Tensione massima (V)	48	48	48
Corrente massima (A)	25	25	25
Colore	● nero	○ bianco	○ trasparente
Materiale	Rame/plastica	Rame/plastica	Rame/plastica
Diametro (cm)/Lunghezza (cm)	0,6 / 2000	0,6 / 2000	0,6 / 2000
Articolo	139050	139051	139026
EUR	58,00	58,00	58,00

TENSEO, Cavo a bassa tensione 6 mm², 100 m



	100 m	100 m	100 m
Tensione massima (V)	48	48	48
corrente massima (A)	25	25	25
Colore	● nero	○ bianco	○ trasparente
Materiale	Rame/plastica	Rame/plastica	Rame/plastica
Diametro (cm)/Lunghezza (cm)	0,6 / 10000	0,6 / 10000	0,6 / 10000
Articolo	139060	139061	139006
EUR	287,00	287,00	287,00



139131 489

**12V AC | 50VA convenzionale**Acciaio/ottone
H: 11 cm Ø: 11,1 cm

● nero	Articolo	1002691	111,00 EUR
○ bianco		1002692	111,00 EUR
● cromo		1002693	115,00 EUR

**12V AC | 105VA convenzionale**Acciaio/ottone
H: 11 cm Ø: 11,1 cm

○ bianco	Articolo	138981	135,00 EUR
● cromo		138982	147,00 EUR

**12V AC | 210VA convenzionale**Acciaio/ottone
H: 11 cm Ø: 13,5 cm

○ bianco	Articolo	138991	204,00 EUR
● cromo		138992	213,00 EUR

**Tiracavo (2 pezzi)**25A max. | Ottone
H: 11 cm Ø: 1 cm

● nero	Articolo	181530	28,50 EUR
○ bianco		181531	28,50 EUR
● cromo		181532	30,75 EUR

**Attacco a parete fisso (2 pezzi)**Acciaio/ottone
L: 3 cm Ø: 5 cm

● nero	Articolo	186300	28,50 EUR
○ bianco		186301	28,50 EUR
● cromo		186302	30,75 EUR

**Sostegno 6 cm (2 pezzi)**Acciaio/ottone
H: 6 cm Ø: 5 cm

● nero	Articolo	186330	24,50 EUR
○ bianco		186331	24,50 EUR
● cromo		186332	28,50 EUR

**Sostegno 16 cm (2 pezzi)**Acciaio/ottone
H: 16 cm Ø: 5 cm

● nero	Articolo	186340	28,50 EUR
○ bianco		186341	28,50 EUR
● cromo		186342	30,75 EUR

**Attacco a parete flessibile tiracavo (2 pezzi)**Acciaio/ottone
H: 11,5 cm Ø: 5 cm

● nero	Articolo	186310	40,50 EUR
○ bianco		186311	40,50 EUR
● cromo		186312	42,75 EUR

**Deviatore (2 pezzi)**Acciaio/ottone
H: 16 cm Ø: 5 cm

● nero	Articolo	186640	92,00 EUR
○ bianco		186641	92,00 EUR
● cromo		186642	99,00 EUR

**Morsetto di alimentazione (2 pezzi)**25A max. | Ottone
H: 1,8 cm Ø: 1 cm

● nero	Articolo	186350	12,20 EUR
○ bianco		186351	12,20 EUR
● cromo		186352	13,70 EUR

**Raccordo isolamento (2 pezzi)**25A max. | Alluminio / Plastica
L: 6,4 cm Ø: 1 cm

● nero	Articolo	186360	22,75 EUR
○ bianco		186361	22,75 EUR
● cromo		186362	24,50 EUR

**Distanziale di isolamento (2 pezzi)**Alluminio
La: 9 cm Ø: 1,25 cm

● nero	Articolo	1002700	46,50 EUR
○ bianco		1002701	46,50 EUR
● cromo		1002702	56,00 EUR

**Distanziale elettrico (2 pezzi)**25A max. | Ottone
H: 9 cm Ø: 1,25 cm

● nero	Articolo	1002703	56,00 EUR
○ bianco		1002704	56,00 EUR
● cromo		1002705	62,00 EUR

**Set di sospensione 2m**Acciaio/alluminio
La: 18,6 cm Ø: 1,25 cm

● nero	Articolo	1002697	40,50 EUR
○ bianco		1002698	40,50 EUR
● cromo		1002699	42,75 EUR



139071 486

ASMARA LV, QR-C51

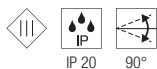
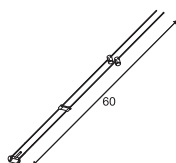

12V ~50Hz
Materiale: acciaio



Attacco: 1xGX5.3

Versione	Articolo	EUR
● nero	139070	28,25
○ bianco	139071	28,25
● cromo	139072	30,75



LED GU5.3 | 5,8W | 36°
2700K | 450lm | Classe=G
6kWh/1000h

Articolo: 1001574 | 35,00 EUR



TELESKOP LV, QR-C51

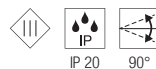
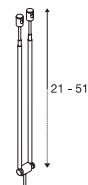

12V ~50Hz
Materiale: acciaio

- Asta telescopica regolabile tra 21-51 cm



Attacco: 1xGX5.3

Versione	Articolo	EUR
● nero	139080	33,75
○ bianco	139081	33,75
● cromo	139082	36,75



LED GU5.3 | 5,8W | 36°
2700K | 450lm | Classe=G
6kWh/1000h

Articolo: 1001574 | 35,00 EUR

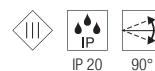
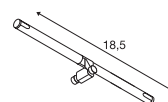

**COSMIC**
LV, QR-C51**139090** **487**12V ~50Hz
Materiale: acciaio/ottone**SOCKET**
INSIDE  <35
W

Attacco: 1xGX5.3

Versione	Articolo	EUR
● nero	139090	40,25
○ bianco	139091	40,25
● cromo	139092	42,50

LED GU5.3 | 5,8W | 36°
2700K | 450lm | Classe=G
6kWh/1000h**Articolo: 1001574 | 35,00 EUR**

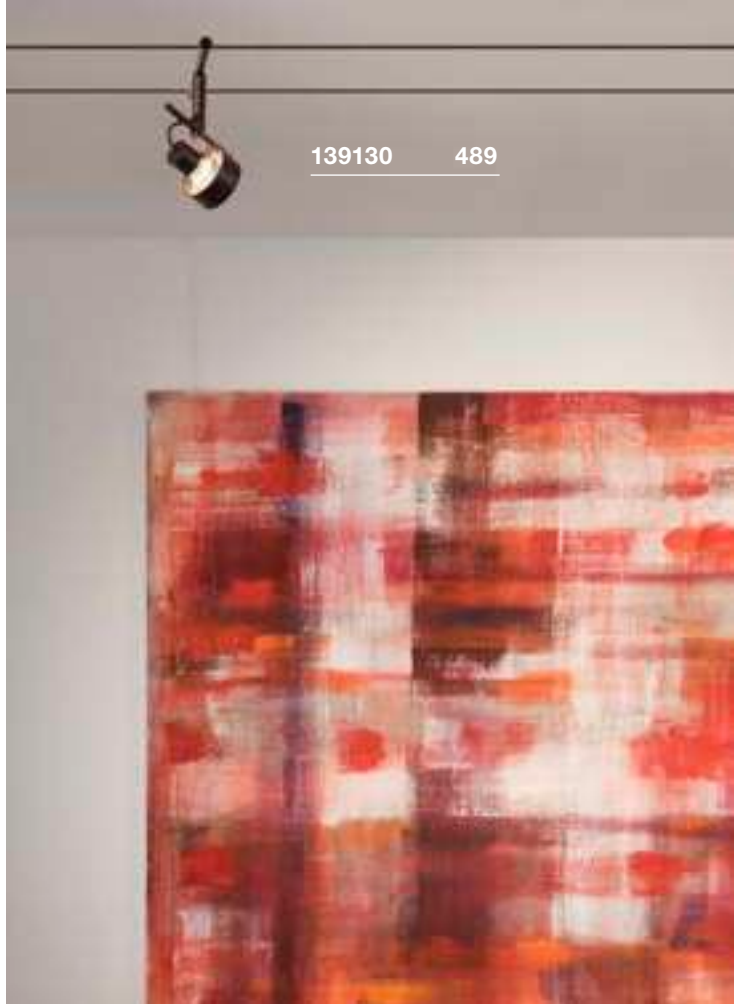



SYROS
LV, QR-C51

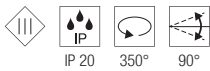
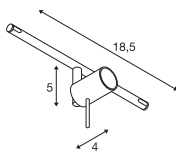

12V ~50Hz
Materiale: acciaio



Attacco: 1xGX5.3

Versione	Articolo	EUR
● nero	139100	55,00
○ bianco	139101	55,00
● cromo	139102	62,00



LED GU5.3 | 5,8W | 36°
2700K | 450lm | Classe=G
6kWh/1000h

Articolo: 1001574 | 35,00 EUR



SALUNA
LV, QR-C51

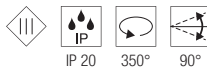
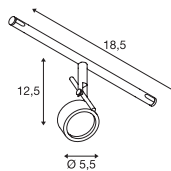

12V ~50Hz
Materiale: acciaio/ottone



Attacco: 1xGX5.3

Versione	Articolo	EUR
● nero	139130	72,00
○ bianco	139131	72,00
● cromo	139132	78,00



LED GU5.3 | 5,8W | 36°
2700K | 450lm | Classe=G
6kWh/1000h

Articolo: 1001574 | 35,00 EUR



DURNO
LV

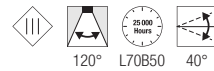
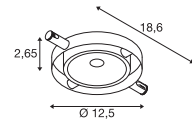

12V ~50Hz
Potenza assorbita: 6W
Materiale: alluminio/acciaio



Down

360lm | 2700K

Versione	Articolo	EUR
● nero	1002861	82,00
○ bianco	1002862	82,00
● cromo/acciaio inox	1002863	86,00

1002864 490

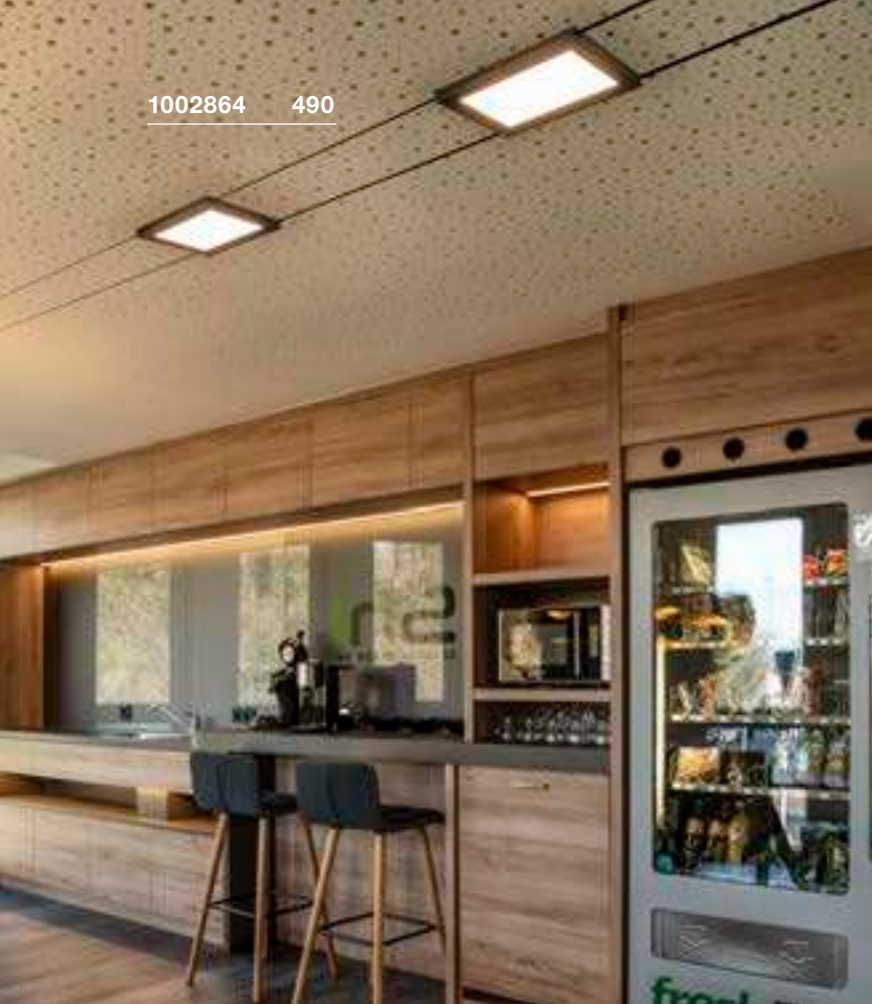

PLYTTA LV

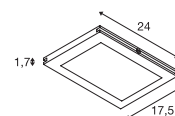

1002690 491

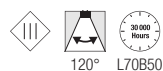

12V ~50Hz
Potenza assorbita: 9,8W
Materiale: alluminio/plastica



Down

750lm | 2700K

Versione	Articolo	EUR
● nero CRI80	1002864	65,00
○ bianco CRI90	1002865	65,00
● cromo CRI90	1002866	70,00



NOBLO® SPOT LV, Rope Track

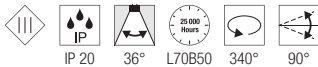
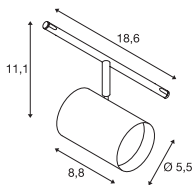

12V ~50Hz
Potenza assorbita: 8,5 W
Materiale: alluminio



Down 420lm | 2700K
450lm

Versione	Articolo	EUR
● nero 420lm	1002694	80,00
○ bianco 450lm	1002695	80,00
● cromo 450lm	1002696	85,00

COMET LED LV

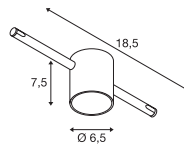

12V ~50Hz
Potenza assorbita: 6,6W
Materiale: alluminio/vetro



Down 410lm | 2700K

Versione	Articolo	EUR
● cromo/smerigliato	1002690	83,00

COMET LV, QR-C51

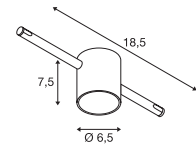

12V ~50Hz
Materiale: ottone



Attacco: 1xGU5.3

Versione	Articolo	EUR
● nero	139120	55,00
○ bianco	139121	55,00
● cromo	139122	62,00



LED GU5.3 | 5,8W | 36°
2700K | 450lm | Classe=G
6kWh/1000h

Articolo: **1001574** | **35,00 EUR**



1007354 503





NEW

LED
NOBLO® SPOT | 501



NEW

LED
NOBLO® SPOT | 501



NEW

LED
NOBLO® SPOT | 503



NEW

LED
NOBLO® SPOT | 503



NEW

SCKET
ASTO TUBE | 505



NEW

SCKET
PANTILO
ROPE 19 | 505



LED
HELIA 50 TRACK | 507



LED
PANEL TRACK | 507



LED
PANEL TRACK | 507



SCKET
PARA CONE GL | 508



SCKET
PARA CONE GL | 508



SCKET
PARA CONE 14 | 509



SCKET
PARA CONE 14 | 509



SCKET
TONGA® | 511



SCKET
LIGHT EYE® 90 | 511



SCKET
LIGHT EYE® 150 | 511



SCKET
FORCHINI M 40
TRACK | 512



SCKET
PURI TRACK | 513



SCKET
PURI TRACK | 513



SCKET
PURI TRACK | 515



SCKET
AVO TRACK | 515



LED
ENOLA C TRACK | 516



LED
ENOLA C TRACK | 517



SCKET
ENOLA B TRACK | 517



SCKET
ENOLA B | 517



SCKET
BIMA | 519



SCKET
BIMA | 519



LED
KALU TRACK | 520



SCKET
KALU TRACK | 520



SCKET
EURO SPOT
TRACK | 521



SCKET
ALTRA DICE
TRACK | 521



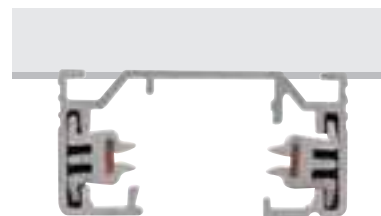

BINARIO MONOFASE

POSA IN SUPERFICIE, PARETE/PLAFONE



	1 m	1 m	1 m
Tensione nominale (V)	220-240V ~50/60Hz	250V ~50/60Hz	220-240V ~50/60Hz
Corrente massima (A)	16	16	16
Colore	● nero	○ bianco	● grigio
Materiale	Alluminio	Alluminio	Alluminio
L x La x A (cm)	100 x 3,5 x 1,8	100 x 3,5 x 1,8	100 x 3,5 x 1,8
Articolo	143010	143011	143012
EUR	35,50	35,50	35,50
	2 m	2 m	2 m
Tensione nominale (V)	220-240V ~50/60Hz	250V ~50/60Hz	220-240V ~50/60Hz
Corrente massima (A)	16	16	16
Colore	● nero	○ bianco	● grigio
Materiale	Alluminio	Alluminio	Alluminio
L x La x A (cm)	200 x 3,5 x 1,8	200 x 3,5 x 1,8	200 x 3,5 x 1,8
Articolo	143020	143021	143022
EUR	67,00	67,00	67,00
	3 m	3 m	3 m
Tensione nominale (V)	250V ~50/60Hz	250V ~50/60Hz	250V ~50/60Hz
Corrente massima (A)	16	16	16
Colore	● nero	○ bianco	● grigio
Materiale	Alluminio	Alluminio	Alluminio
L x La x A (cm)	300 x 3,5 x 1,8	300 x 3,5 x 1,8	300 x 3,5 x 1,8
Articolo	1002151	1002152	1002153
EUR	100,00	100,00	100,00

BINARIO MONOFASE

Posa in superficie, parete/plafone
Guida alla progettazione e panoramica accessori

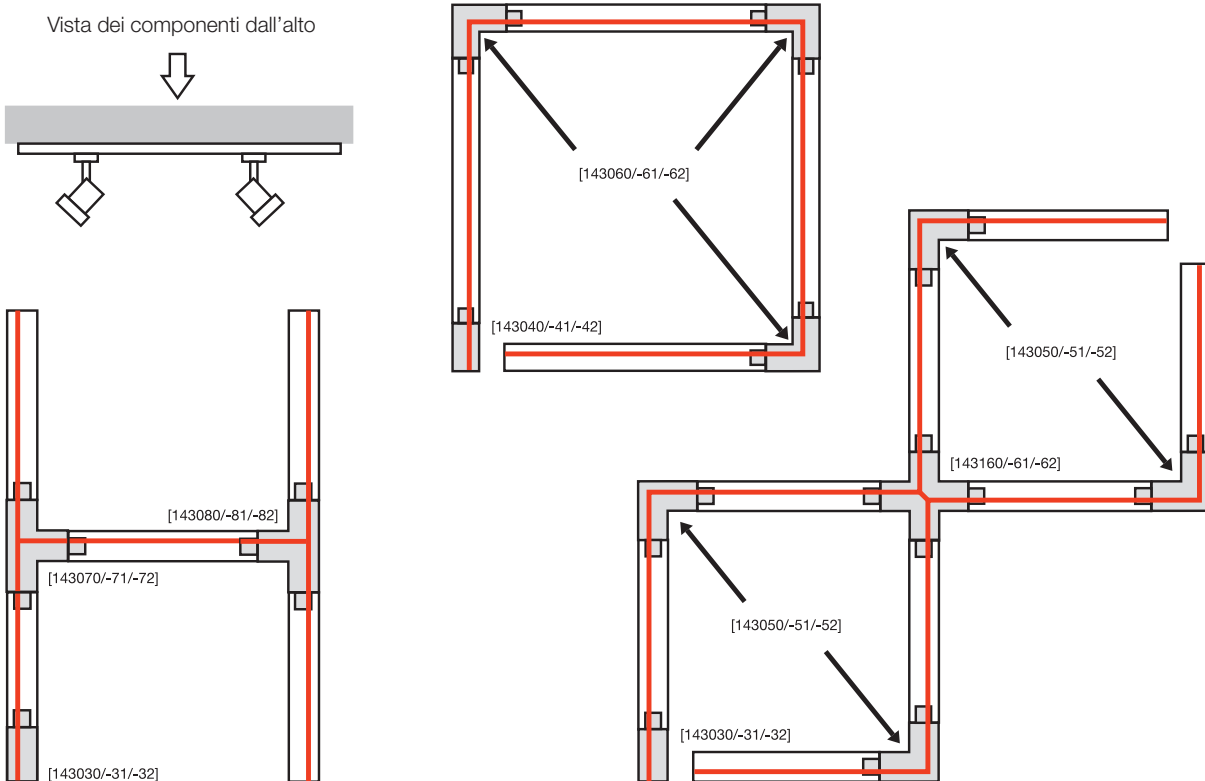

**Testata alimentazione, terra a sinistra**16A max. | Policarbonato (PC)
L: 6,5 cm La: 3,5 cm H: 1,8 cm

● nero	Articolo	143030	9,35 EUR
○ bianco		143031	9,35 EUR
● grigio		143032	9,35 EUR

**Staffa di stabilizzazione longitudinale**Acciaio
L: 19,7 cm | La: 3,2 cm | H: 1,3 cm
Come rinforzo in caso di montaggio di più binari con cavi di sospensione (1002845)

● nichel	Articolo	143151	7,10 EUR
----------	----------	--------	----------

**Testata alimentazione, terra a destra**16A max. | Policarbonato (PC)
L: 6,5 cm La: 3,5 cm H: 1,8 cm

● nero	Articolo	143040	9,35 EUR
○ bianco		143041	9,35 EUR
● grigio		143042	9,35 EUR

**Staffa di stabilizzazione angolare**Acciaio
L: 11,5 cm La: 11,5 cm H: 0,5 cm
Come rinforzo in caso di montaggio di più binari con cavi di sospensione (1002845)

● nichel	Articolo	143152	8,25 EUR
----------	----------	--------	----------

**Raccordo longitudinale con possibilità di alimentazione**16A max. | Policarbonato (PC)
L: 17,2 cm La: 3,5 cm H: 1,8 cm

● nero	Articolo	143100	17,50 EUR
○ bianco		143101	17,50 EUR
● grigio		143102	17,50 EUR

**Staffa di stabilizzazione a X**Acciaio
L: 19,7 cm | La: 19,7 cm | H: 0,5 cm
Come rinforzo in caso di montaggio di più binari con cavi di sospensione (1002845)

● grigio	Articolo	143169	12,50 EUR
----------	----------	--------	-----------

**Raccordo longitudinale**16A max. | Policarbonato (PC)
L: 6,4 cm La: 3,5 cm H: 1,8 cm

● nero	Articolo	143090	7,10 EUR
○ bianco		143091	7,10 EUR
● grigio		143092	7,10 EUR

**Adattatore monofase**6A max. | Policarbonato (PC)
L: 8,5 cm La: 3,5 cm H: 3,2 cm

● nero	Articolo	143120	15,00 EUR
○ bianco		143121	15,00 EUR
● grigio		143124	15,00 EUR

**Raccordo angolare, terra interna**16A max. | Policarbonato (PC)
L: 10,4 cm | La: 10,4 cm | H: 1,8 cm

● nero	Articolo	143060	16,40 EUR
○ bianco		143061	16,40 EUR
● grigio		143062	16,40 EUR

**Adattatore monofase con gancio**6A max. | Policarbonato (PC)
L: 8,5 cm La: 3,5 cm H: 7,4 cm

● nero	Articolo	143170	15,00 EUR
○ bianco		143171	15,00 EUR
● grigio		143172	15,00 EUR

**Raccordo angolare, terra esterna**16A max. | Policarbonato (PC)
L: 10,4 cm | La: 10,4 cm | H: 1,8 cm

● nero	Articolo	143050	16,40 EUR
○ bianco		143051	16,40 EUR
● grigio		143052	16,40 EUR

**Copertura superficie/incasso**Policarbonato (PC)
L: 200 cm La: 1,8 cm H: 0,75 cm

● nero	Articolo	1004783	21,00 EUR
○ bianco		1004785	21,00 EUR
● grigio		1004784	21,00 EUR

**Raccordo a T, terra esterna, sinistra**16A max. | Policarbonato (PC)
L: 17,2 cm La: 10,4 cm H: 1,8 cm

● nero	Articolo	143070	20,75 EUR
○ bianco		143071	20,75 EUR
● grigio		143072	20,75 EUR

**Calotta di chiusura (2 pezzi)**Policarbonato (PC)
L: 0,4 cm La: 3,5 cm H: 1,8 cm

● nero	Articolo	143130	4,40 EUR
○ bianco		143131	4,40 EUR
● grigio		143132	4,40 EUR

**Raccordo a T, terra esterna, destra**16A max. | Policarbonato (PC)
L: 17,2 cm La: 10,4 cm H: 1,8 cm

● nero	Articolo	143080	20,75 EUR
○ bianco		143081	20,75 EUR
● grigio		143082	20,75 EUR

**Rosone plafone/parete**6A max. | Policarbonato (PC)
H: 2,5 cm Ø: 11,5 cm

● nero	Articolo	143380	20,75 EUR
○ bianco		143381	20,75 EUR
● grigio		143382	20,75 EUR

**Raccordo a X**16A max. | Policarbonato (PC)
L: 9,5 cm La: 17,2 cm H: 1,8 cm

● nero	Articolo	143160	31,25 EUR
○ bianco		143161	31,25 EUR
● grigio		143162	31,25 EUR

**Set cavo di sospensione (2 pezzi)**Acciaio inox/ottone
L: 500 cm

● nichel	Articolo	1002845	41,75 EUR
----------	----------	---------	-----------

**Raccordo flessibile**16A max. | Policarbonato (PC)
L: 16,4 cm La: 3,5 cm H: 1,8 cm

● nero	Articolo	143110	17,50 EUR
○ bianco		143111	17,50 EUR
● grigio		143112	17,50 EUR

143580 507





BINARIO MONOFASE INCASSO

Posa a incasso, accessori

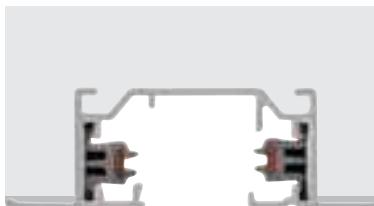
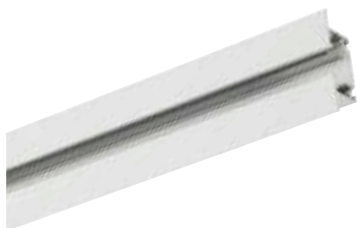

	2 m
Tensione nominale (V)	250V ~50/60Hz
Corrente massima (A)	16
Colore	○ bianco
Materiale	Alluminio
L x La x A (cm)	200 x 5,5 x 1,8
Articolo	143221
EUR	74,00

Testata alimentazione, terra a sinistra
16A max. | Plastica
L: 10,8 cm | La: 5,5 cm | H: 2 cm

○ bianco Articolo **143231** **13,90 EUR**

Calotta terminale (2 pezzi)
Plastica
L: 2,7 cm La: 5,5 cm H: 1,8 cm

○ bianco Articolo **143281** **7,10 EUR**

Testata alimentazione, terra a destra
16A max. | Plastica
L: 10,8 cm | La: 5,5 cm | H: 2 cm

○ bianco Articolo **143241** **13,90 EUR**

Staffa di fissaggio
Acciaio
L: 7,5 cm La: 1,5 cm H: 4 cm

● nichel Articolo **143230** **3,80 EUR**

Raccordo longitudinale con stabilizzatore
16A max. | Plastica/Acciaio
L: 6,5 cm La: 1,8 cm H: 1,7 cm

○ bianco Articolo **143271** **13,90 EUR**

Adattatore monofase con gancio
6A max. | Policarbonato (PC)
L: 8,5 cm La: 3,5 cm H: 7,4 cm

● nero Articolo **143170** **15,00 EUR**
○ bianco **143171** **15,00 EUR**
● grigio **143172** **15,00 EUR**

Raccordo angolare, terra interna
16A max. | Plastica
L: 11,2 cm La: 11,2 cm H: 2 cm

○ bianco Articolo **143261** **20,75 EUR**

Adattatore monofase
6A max. | Policarbonato (PC)
L: 8,5 cm La: 3,5 cm H: 3,2 cm

● nero Articolo **143120** **15,00 EUR**
○ bianco **143121** **15,00 EUR**
● grigio **143124** **15,00 EUR**

Raccordo angolare, terra esterna
16A max. | Plastica
L: 11,2 cm La: 11,2 cm H: 2 cm

○ bianco Articolo **143251** **20,75 EUR**

1007639 501





NOBLO® SPOT Monofase, Triple Track Set

NOBLO® SPOT Monofase, PHASE

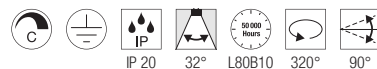
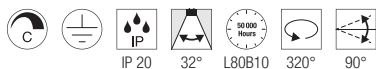
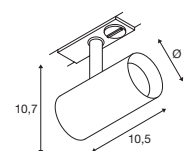
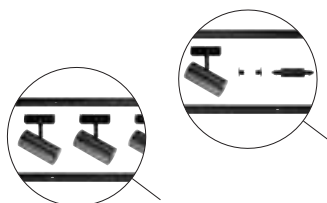

220-240V ~50/60Hz | 150mA
Potenza assorbita: 19W
Materiale: alluminio

220-240V ~50/60Hz | 150mA
Potenza assorbita: 6,2W
Materiale: alluminio/polycarbonato (PC)



Down 2250lm | 2700K

Down 740lm | 2700K

Versione	Articolo	EUR
● nero	1007673	255,00
○ bianco	1007674	255,00

Versione	Articolo	EUR
● nero	1007638	70,00
○ bianco	1007639	70,00
● grigio	1007640	70,00

1007352 503

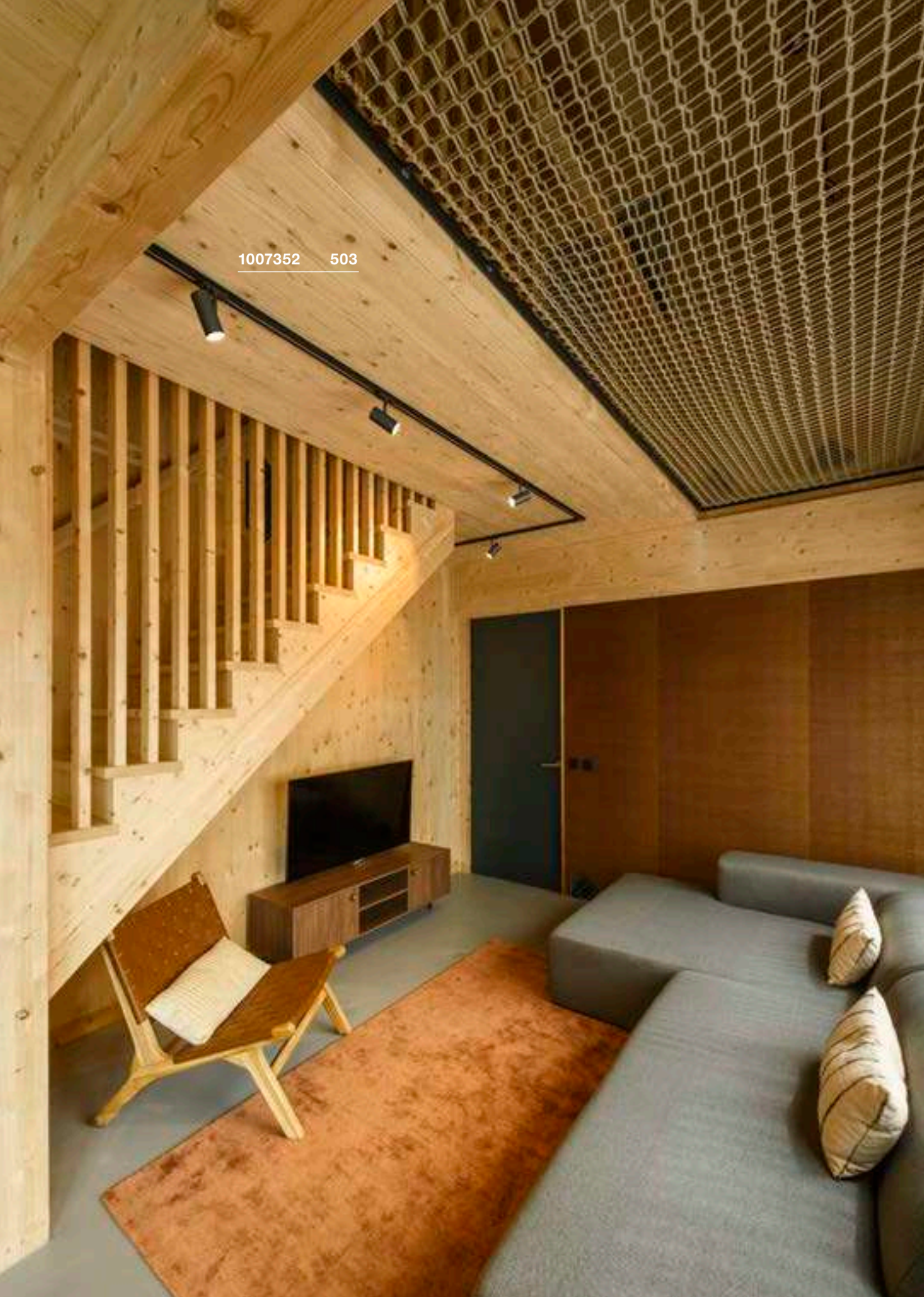



NOBLO® SPOT
Monofase, PHASE

NOBLO® SPOT
Monofase, PHASE

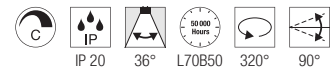
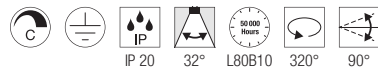
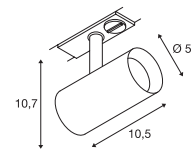
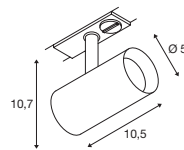

220-240V ~50/60Hz | 150mA
Potenza assorbita: 6,2W
Materiale: alluminio/policarbonato (PC)

220-240V ~50/60Hz | 350mA
Potenza assorbita: 8,4W
Materiale: alluminio/policarbonato (PC)



Down 750lm | 3000K

Down 30lm | 2000K - 450lm | 3000K

Versione	Articolo	EUR
● nero	1007641	70,00
○ bianco	1007642	70,00
● grigio	1007643	70,00

Versione	Articolo	EUR
● nero	1007352	85,00
○ bianco	1007353	85,00
● grigio	1007354	85,00

1006445 505





ASTO TUBE Monofase, GU10



NEW

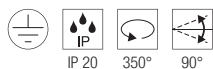
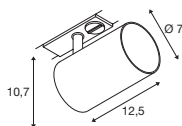

220-240V ~50/60Hz
Materiale: alluminio

SOCKET INSIDE 10 W

Attacco: 1xGU10

Versione	Articolo	EUR
● nero	1006445	70,00
○ bianco	1006446	70,00



LED GU10 51mm | 6W | 38°
2700K | 450lm | Classe=F
6kWh/1000h



Articolo: 1005077 | 7,50 EUR

ASTO TUBE Riflettore decorativo



NEW

H: 3,95 cm
Ø: 6,75 cm
Materiale: policarbonato (PC)

Versione	Articolo	EUR
● nero/cromo	1007190	4,00
● oro	1006450	4,00
● cromo	1006449	4,00
● rame	1006451	4,00

PANTILO ROPE 19 PD, E27



NEW

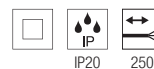
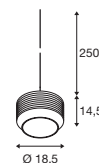

200-240V ~50/60Hz
Materiale: acciaio/vetro/canapa

- Cavo con terminale aperto

SOCKET INSIDE <15 W

Attacco: 1xE27 Ø max.: 10 cm L: 11 cm

Versione	Articolo	EUR
● ambra/oro	1007597	199,00
● antracite/argento	1007596	199,00



A60 | 7,5W | 180°
2700K | 720lm | Classe=F
8kWh/1000h



Articolo: 1005305 | 19,00 EUR





HELIA 50 TRACK Monofase

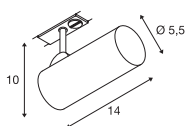

220-240V ~50/60Hz | 500mA
Potenza assorbita: 11W
Materiale: alluminio



Down 810lm | 880lm | 3000K

Versione	Articolo	EUR
● nero		
810lm	143580	90,00
○ bianco		
880lm	143581	90,00

PANEL TRACK Monofase, quadrato

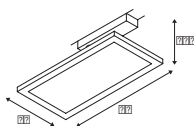

220-240V ~50/60Hz | 450mA
Potenza assorbita: 18W
Materiale: policarbonato (PC)/acciaio



Down 1800lm | 3000K

Versione	Articolo	EUR
● nero	1004933	96,00
○ bianco	1004934	96,00

PANEL TRACK Monofase, rotondo

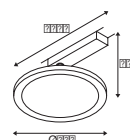

220-240V ~50/60Hz | 450mA
Potenza assorbita: 18W
Materiale: policarbonato (PC)/acciaio



Down 1800lm | 3000K

Versione	Articolo	EUR
● nero	1004935	96,00
○ bianco	1004936	96,00

PARA CONE GL
Monofase, GU10

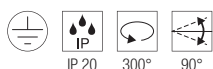
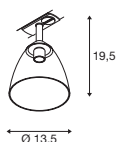

220-240V ~50/60Hz
Materiale: alluminio/vetro



Attacco: 1xGU10

Versione	Articolo	EUR
● nero	1006155	89,00
○ bianco	1006156	89,00



LED GU10 51mm | 3,2W
2700K | 270lm | Classe=G



Articolo: 1006321 | 48,00 EUR

PARA CONE GL
PD, GU10

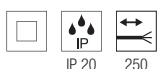
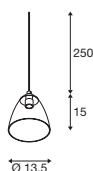

220-240V ~50/60Hz
Materiale: alluminio/vetro

- Cavo con terminale aperto
- Adattatore monofase da acquistare a parte



Attacco: 1xGU10

Versione	Articolo	EUR
● nero	1006159	84,00
○ bianco	1006160	84,00



LED GU10 51mm | 3,2W
2700K | 270lm | Classe=G



Articolo: 1006321 | 48,00 EUR



Articolo	Articolo	EUR
Adattatore monofase		
● nero	143120	15,00
○ bianco	143121	15,00
● grigio	143124	15,00



1006160 508



1006155 508

PARA CONE 14
Monofase, QPAR51

PARA CONE 14
Monofase, PD, QPAR51

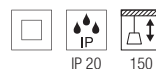
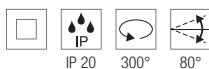
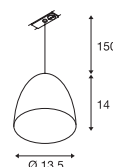
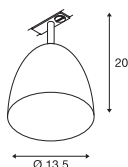

220-240V ~50/60Hz
Materiale: acciaio

220-240V ~50/60Hz
Materiale: alluminio

- Cavo in tessuto
- Versioni nero e bianco con riflettore dorato
- Versione rame con riflettore bianco

- Cavo in tessuto
- Versioni nero e bianco con riflettore dorato
- Versione rame con riflettore bianco
- Adattatore monofase incluso

1002875 509



Attacco: 1xGU10

Attacco: 1xGU10

Versione	Articolo	EUR
● nero	1002873	86,00
○ bianco	1002874	86,00
● rame	1002875	89,00

Versione	Articolo	EUR
● nero	143990	117,00
○ bianco	143991	117,00
● rame	1001968	124,00



LED GU10 51mm | 3,2W
2700K | 270lm | Classe=G



Articolo: 1006321 | 48,00 EUR



LED GU10 51mm | 3,2W
2700K | 270lm | Classe=G



Articolo: 1006321 | 48,00 EUR



143594

511



144011

511



1000713

511



TONGA®

Monofase, PD, E14

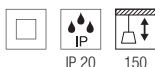
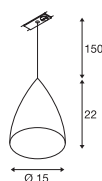

220-240V ~50/60Hz
Materiale: alluminio/vetro

- Adattatore monofase incluso



Attacco: 1xE14 max. Ø: 5,1 cm L: 13 cm

Versione	Articolo	EUR
● grigio / opalescente	143594	129,00



C35 | 4,2W | 320°
2700K | 350lm | Classe=G
5kWh/1000h



Articolo: 1005285 | 8,50 EUR

LIGHT EYE® 90

Monofase, QPAR51

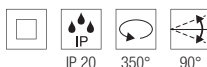
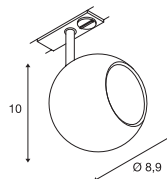

230V ~50/60Hz
Materiale: acciaio



Attacco: 1xGU10

Versione	Articolo	EUR
● nero	144010	84,00
○ bianco	144011	84,00
● rame	144019	95,00



LED GU10 51mm | 6W | 36°
2200-2700K | 360lm | Classe=G
6kWh/1000h



Articolo: 1005273 | 9,99 EUR

LIGHT EYE® 150

Monofase, PD, QPAR111

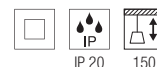
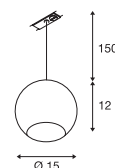

220-240V ~50/60Hz
Materiale: acciaio

- Adattatore monofase incluso



Attacco: 1xGU10

Versione	Articolo	EUR
● nero	1000713	132,00
○ bianco	143621	132,00



LED GU10 51mm | 6W | 38°
2700K | 450lm | Classe=F
6kWh/1000h



Articolo: 1005077 | 7,50 EUR

FORCHINI M 40 TRACK
Monofase, E27

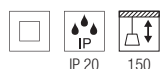
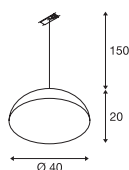

IP 20 150



220-240V ~50/60Hz
Materiale: alluminio/acciaio

Adattatore per sospensioni:
grigio argento [143930] / nero [143932]

SOCKET
INSIDE <40
W

Attacco: 1xE27 Ø max.: 6,8 cm L: 15,2 cm

Versione	Articolo	EUR
●● nero/oro	143930	233,00
●● nero/oro	143932	233,00

 A60 | 7,5W | 180°
2700K | 720lm | Classe=F  
8kWh/1000h

Articolo: 1005305 | 19,00 EUR



143932 512



1001868 513



PURI TRACK

Monofase, Triple Track Set

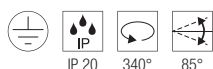

220-240V ~50/60Hz
Potenza assorbita: 4,3W
Materiale: alluminio

- Composto da 2 x binario 1m,
1 x Raccordo longitudinale
con alimentazione,
2 x Calotte terminali,
3 x Faretti Puri con anello decorativo,
3 x Lampadina LED GU10 2700K

Versione	Articolo	EUR
● nero	143190	199,00
○ bianco	143191	199,00

PURI TRACK

Monofase, QPAR51

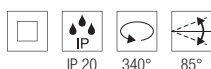
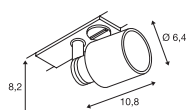

220-240V ~50/60Hz
Materiale: alluminio/plastica



Attacco: 1xGU10

Versione	Articolo	EUR
● nero	1001868	45,00
○ bianco	1001869	45,00



LED GU10 51mm | 6W | 38°
2700K | 450lm | Classe=F
6kWh/1000h



Articolo: 1005077 | 7,50 EUR

PURI TRACK

Monofase, QPAR51

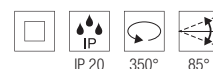
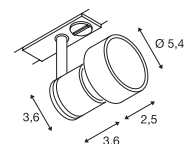

220-240V ~50/60Hz
Materiale: alluminio/polycarbonato (PC)



Attacco: 1xGU10

Versione	Articolo	EUR
● nero	143390	34,00
○ bianco	143391	34,00
● grigio	143392	34,00



LED GU10 51mm | 6W | 38°
2700K | 450lm | Classe=F
6kWh/1000h



Articolo: 1005075 | 7,50 EUR

- Anello decorativo incluso

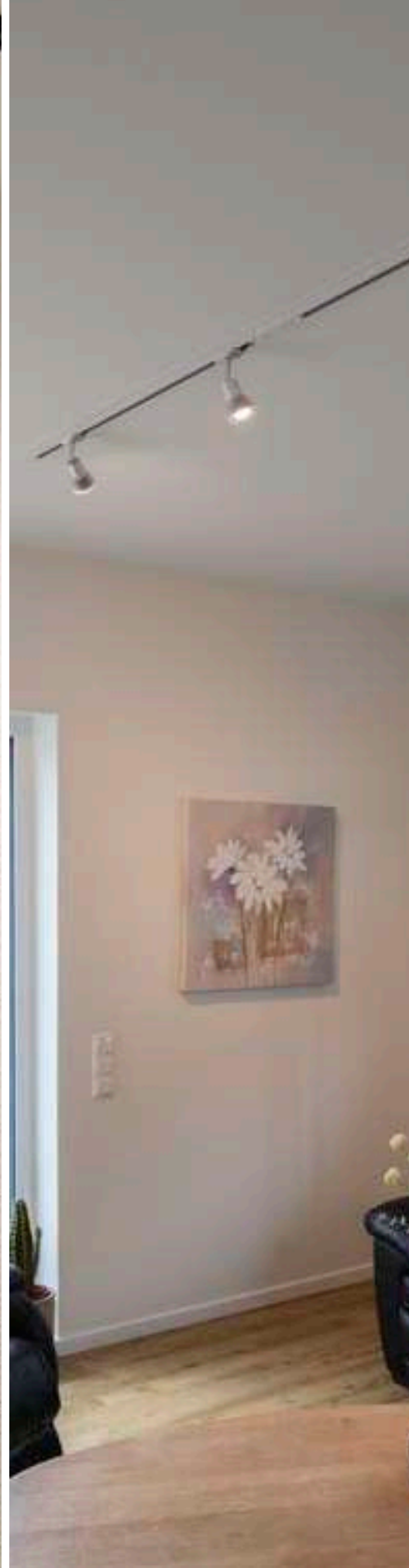

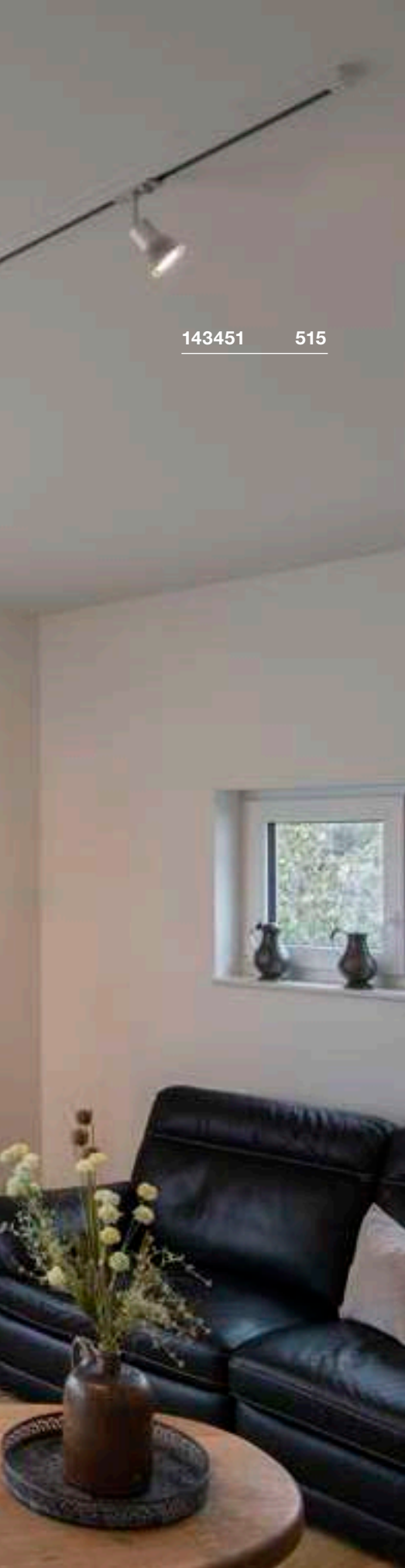

143451 515

PURIA TRACK Monofase, QPAR51

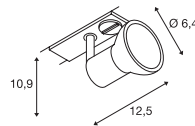

220-240V ~50/60Hz
Materiale: alluminio/plastica



Attacco: 1xGU10

Versione	Articolo	EUR
● nero	143450	42,75
○ bianco	143451	42,75
● grigio	143454	42,75



LED GU10 51mm | 6W | 36°
2200-2700K | 360lm | Classe=G
6kWh/1000h



Articolo: 1005273 | 9,99 EUR

AVO TRACK Monofase, QPAR51

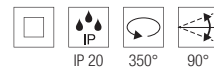
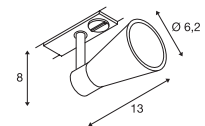

220-240V ~50/60Hz
Materiale: acciaio



Attacco: 1xGU10

max. Ø: 5,1 cm

Versione	Articolo	EUR
● nero	144200	38,50
○ bianco	144201	38,50
● grigio	144204	38,50



LED GU10 51mm | 6W | 38°
2700K | 450lm | Classe=F
6kWh/1000h



Articolo: 1005077 | 7,50 EUR

ENOLA C TRACK

Monofase

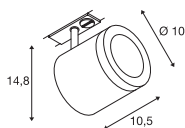

220-240V ~50/60Hz | 500mA
 Potenza assorbita: 11W
 Materiale: alluminio/vetro



Down 1040lm | 3000K

Versione	Articolo	EUR
● nero	1000711	177,00
○ bianco	143941	177,00





ENOLA C TRACK Monofase

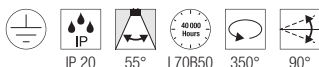
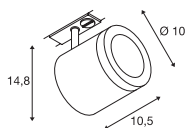

220-240V ~50/60Hz | 500mA
Potenza assorbita: 11W
Materiale: alluminio/vetro



Down 1040lm | 3000K

Versione	Articolo	EUR
● nero	1000712	177,00
○ bianco	143951	177,00

ENOLA B TRACK Monofase, QPAR51

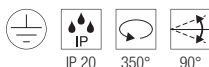
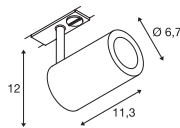

220-240V ~50/60Hz
Materiale: alluminio/acciaio



Attacco: 1xGU10 max. Ø: 5,1 cm | L:6,7 cm

Versione	Articolo	EUR
● nero	1002110	70,00
○ bianco	1002111	70,00
● grigio	1002113	70,00



LED GU10 51mm | 6W | 38°
2700K | 450lm | Classe=F
6kWh/1000h



Articolo: 1005075 | 7,50 EUR

ENOLA B PD, QPAR51

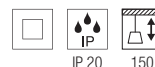
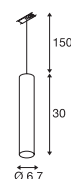

220-240V ~50/60Hz
Materiale: alluminio/acciaio



Attacco: 1xGU10

Versione	Articolo	EUR
● nero	143960	125,00
○ bianco	143961	125,00



LED GU10 51mm | 6W | 38°
2700K | 450lm | Classe=F
6kWh/1000h



Articolo: 1005077 | 7,50 EUR

• Adattatore monofase incluso

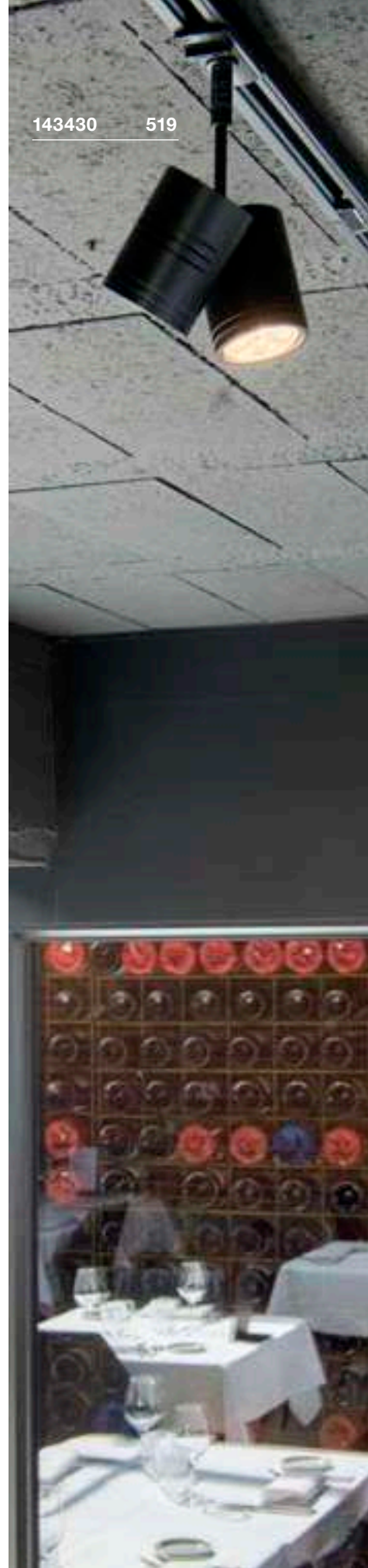



BIMA

Monofase, single, QPAR51

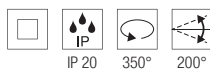
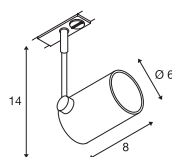

220-240V ~50/60Hz
Materiale: alluminio



Attacco: 1xGU10 max. Ø: 5,1 cm | L: 5,7 cm

Versione	Articolo	EUR
● nero	143440	45,00
○ bianco	143441	45,00
● grigio	143442	45,00



LED GU10 51mm | 6W | 38°
2700K | 450lm | Classe=F
6kWh/1000h



Articolo: 1005075 | 7,50 EUR

BIMA

Monofase, double, QPAR51

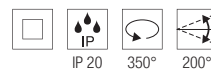
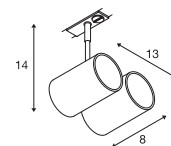

220-240V ~50/60Hz
Materiale: alluminio



Attacco: 2xGU10 max. Ø: 5,1 cm | L: 5,7 cm

Versione	Articolo	EUR
● nero	143430	70,00
○ bianco	143431	70,00
● grigio	143432	70,00



LED GU10 51mm | 6W | 38°
2700K | 450lm | Classe=F
6kWh/1000h



Articolo: 1005077 | 7,50 EUR

KALU TRACK
Monofase, PHASE

KALU TRACK
Monofase, QPAR111

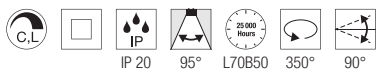
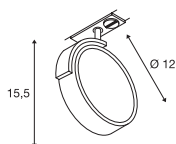
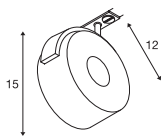

220-240V ~50/60Hz
Potenza assorbita: 13W
Materiale: alluminio

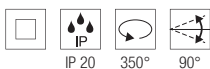

220-240V ~50/60Hz
Materiale: alluminio/plastica



Down 970lm | 3000K

Versione	Articolo	EUR
● nero	1002854	206,00
○ bianco	143731	206,00



Attacco: 1xGU10

Versione	Articolo	EUR
● nero	143540	75,00
○ bianco	143541	75,00
● grigio	143544	75,00



QPAR111 | 12,5W | 10°
3000K | 950lm | Classe=F
13kWh/1000h



Articolo: 1005278 | 55,00 EUR

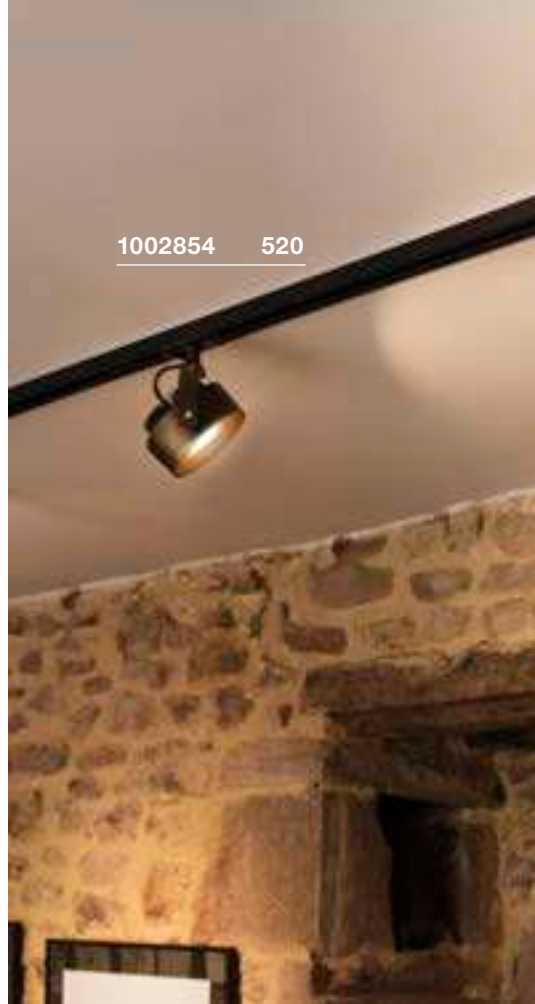

1002854 520



1001861 521



EURO SPOT TRACK

Monofase, QPAR51

ALTRA DICE TRACK

Monofase, QPAR51

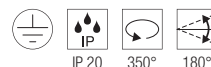
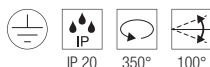
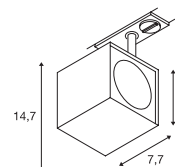
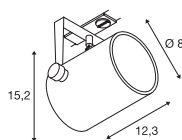

220-240V ~50/60Hz
Materiale: alluminio

220-240V ~50/60Hz
Materiale: alluminio



Attacco: 1xGU10

Attacco: 1xGU10

Versione	Articolo	EUR
● nero	1001861	77,00
○ bianco	143811	77,00

Versione	Articolo	EUR
● nero	143350	85,00
○ bianco	143351	85,00
● grigio	143354	85,00



LED GU10 51mm | 6W | 38°
2700K | 450lm | Classe=F
6kWh/1000h



Articolo: 1005077 | 7,50 EUR



LED GU10 51mm | 6W | 36°
2200-2700K | 360lm | Classe=G
6kWh/1000h



Articolo: 1005273 | 9,99 EUR

143350 521

CONFIGURA IL TUO SISTEMA A BINARIO

Un'illuminazione ben progettata è essenziale, soprattutto dove c'è molto da vedere. Grazie alla versatilità dell'illuminazione con il sistema a binario, si potranno mettere in mostra oggetti specifici. Sarà inoltre possibile apportare modifiche al progetto illuminotecnico in qualsiasi momento. Le barre trifase sono perfette per uffici, negozi, mostre e stand fieristici. Creeranno l'illuminazione perfetta e presenteranno prodotti e oggetti espositivi nella giusta luce. Le barre monofase sono particolarmente adatte per le abitazioni e inonderanno i tuoi spazi di una luce suggestiva. Grazie ai fori presenti, questi binari in alluminio possono essere fissati al soffitto in modo semplice e veloce. Puoi scegliere tra la versione ad incasso e quella con montaggio in superficie, entrambe sono disponibili in più colori.

A TE LA SCELTA:

- 1 Binario (S-TRACK, EUTRAC, monofase)
- 2 Tipo di montaggio (superficie/incasso)
- 3 Apparecchi
- 4 Opzioni di progettazione



FATTO!

SISTEMI A BINARIO

S-TRACK
Trifase



EUTRAC
Trifase



MONOFASE



Incasso



Superficie



Plafone



Parete



Sospensione

Installazione

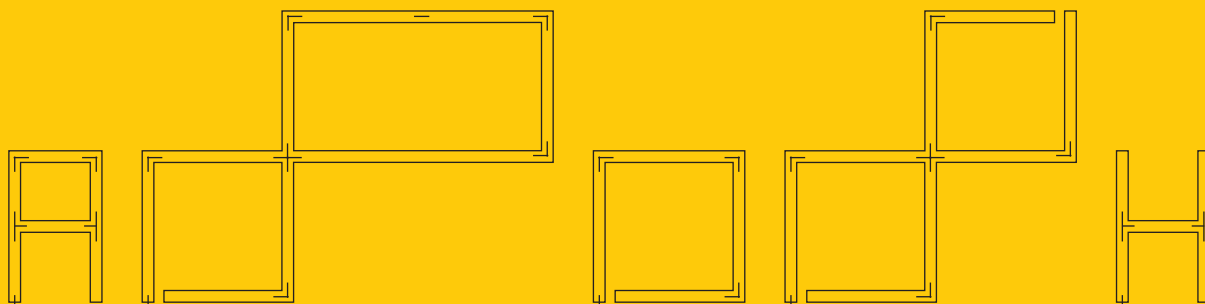

Varie opzioni di personalizzazione in base ai tuoi spazi

Utilizza anche il nostro configuratore di binari [slv.com](https://www.slv.com)



1006159 552



TS V | 543



TS V | 543



LED

NOBLO® SPOT | 545



LED

NOBLO® SPOT | 545



LED

NOBLO® SPOT | 547



LED

NOBLO® SPOT | 547



SCKET
PANTILO
ROPE 19 | 549



LED
SIGHT TRACK | 550



LED
SIGHT TRACK | 550



LED
SIGHT MOVE | 551



LED
SIGHT MOVE | 551



SCKET
PARA CONE GL | 552



SCKET
PARA CONE GL | 552



SCKET
PARA CONE 14 | 553



SCKET
PARA CONE 14 | 553



SCKET
FORCHINI M 40
TRACK | 554



LED
EURO CUBE | 555



SCKET
EURO SPOT
TRACK | 555



SCKET
EURO SPOT
TRACK | 555



SCKET
ALTRA DICE
TRACK | 556



SCKET
PURI TRACK | 557



SCKET
PURI TRACK
GLASS | 557



LED
KALU TRACK
LED | 558



SCKET
KALU TRACK | 558



SCKET
BIMA | 559



SCKET
BIMA | 559



LED
HELIA 50 TRACK | 561





LED
ENOLA C TRACK | 561



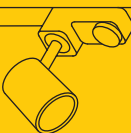

SCKET
AVO TRACK | 561

COMPATIBILITÀ BINARI TRIFASE

Compatibile con apparecchi/adattatori di:

	SLV	Global/Nordic	EUTRAC®
Binari e componenti SLV S-TRACK DALI			
Senza DALI	✓	✓	★
Con DALI	✓	✓	✗

Compatibile con binari e componenti di:

	SLV S-TRACK	Global/Nordic	EUTRAC®
Apparecchi SLV			
Senza DALI	✓	✓	✓
Con DALI	✓	✓	✓★★★

★ Con riserva di preventiva verifica con campioni dell'apparecchio e del binario
★★★ Senza funzionalità DALI

I sistemi a binario SLV e i loro componenti hanno una compatibilità elevata con apparecchi e adattatori di: EUTRAC®, Zumtobel, Erco, LTS ONETrack e unipro® con riserva di preventiva verifica con campioni dell'apparecchio e del binario.

Zumtobel	Erco	LTS ONETrack	unipro®
✓	✓	✓	✓
✗	✗	✓	✓
Zumtobel	Erco	LTS ONETrack	unipro®
✓	✓	✓	✓
✗	✗	✓	✓

Dati forniti senza alcuna assunzione di responsabilità.
 I dati tecnici e le misure possono essere modificati in qualsiasi momento senza preavviso.
 Verificare la funzionalità con campioni già in fase di progettazione.
 La compatibilità si riferisce solo a binari/apparecchi.
 Non abbinare binari e componenti di binari di produttori diversi.





S-TRACK

Binario trifase, posa in superficie, DALI

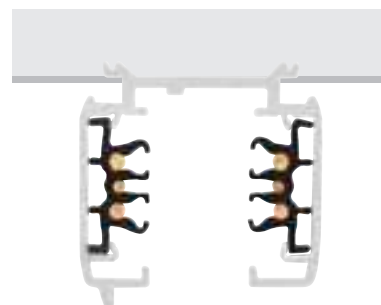

	1 m	1 m	2 m	2 m
Tensione nominale (V)	220-240V ~50/60Hz	220-240V ~50/60Hz	220-250V ~50/60Hz	220-250V ~50/60Hz
Corrente massima (A)	16	16	16	16
Massimo carico meccanico	30 kg	30 kg	30 kg	30 kg
Colore	● nero	○ bianco	● nero	○ bianco
Materiale	Alluminio	Alluminio	Alluminio	Alluminio
L x La x A (cm)	100 x 3,6 x 3,6	100 x 3,6 x 3,6	200 x 3,6 x 3,6	200 x 3,6 x 3,6
Articolo	1004937	1004938	1002631	1002632
EUR	45,50	45,50	81,00	81,00

	3 m	3 m	4 m	4 m
Tensione nominale (V)	220-250V ~50/60Hz	220-250V ~50/60Hz	220-250V ~50/60Hz	220-250V ~50/60Hz
Corrente massima (A)	16	16	16	16
Massimo carico meccanico	30 kg	30 kg	30 kg	30 kg
Colore	● nero	○ bianco	● nero	○ bianco
Materiale	Alluminio	Alluminio	Alluminio	Alluminio
L x La x A (cm)	300 x 3,6 x 3,6	300 x 3,6 x 3,6	400 x 3,6 x 3,6	400 x 3,6 x 3,6
Articolo	1002633	1002634	1002635	1002636
EUR	117,00	117,00	147,00	147,00

S-TRACK

Binario trifase, posa in superficie, DALI
Guida alla progettazione e panoramica accessori

Vista dei componenti dall'alto

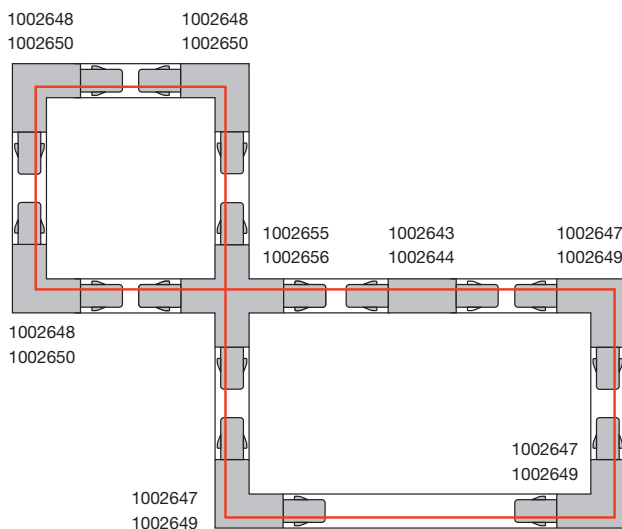
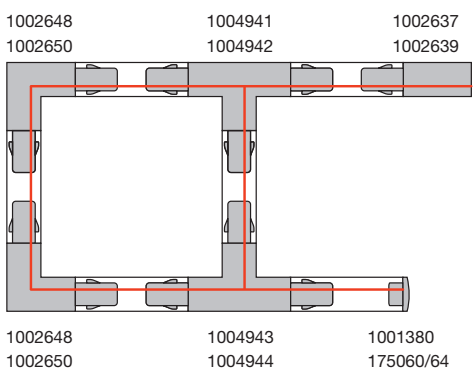
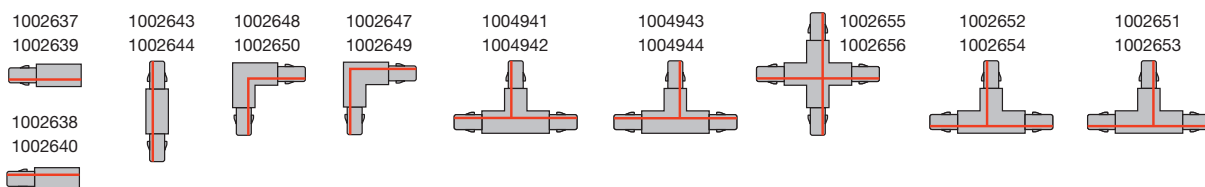
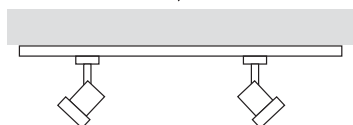

Testata alimentazione, DALI, terra a sinistra
16A max. | Policarbonato (PC)
L: 13,9 cm | La: 3,5 cm | H: 3,3 cm

● nero Articolo **1002637** **19,00 EUR**
○ bianco **1002639** **19,00 EUR**

Raccordo a L, DALI, terra esterna*
16A max. | Policarbonato (PC)
L: 11,9 cm | La: 11,9 cm | H: 3,3 cm

● nero Articolo **1002647** **33,25 EUR**
○ bianco **1002649** **33,25 EUR**

Testata alimentazione, Dalì, terra a destra
16A max. | Policarbonato (PC)
L: 13,9 cm | La: 3,5 cm | H: 3,3 cm

● nero Articolo **1002638** **19,00 EUR**
○ bianco **1002640** **19,00 EUR**

Raccordo a L, DALI, terra interna*
16A max. | Policarbonato (PC)
L: 11,9 cm | La: 11,9 cm | H: 3,3 cm

● nero Articolo **1002648** **33,25 EUR**
○ bianco **1002650** **33,25 EUR**

**Raccordo a T, DALI, terra esterna, sinistra***16A max. | Policarbonato (PC)
L: 20,3 cm | La: 11,9 cm | H: 3,3 cm

● nero	Articolo	1002652	39,00 EUR
○ bianco		1002654	39,00 EUR

**Adattatore trifase, DALI**10A max. | Policarbonato (PC)
L: 11,3 cm | La: 5,5 cm | H: 3,3 cm

● nero	Articolo	1002660	18,70 EUR
○ bianco		1002659	18,70 EUR

**Raccordo a T, Dali, terra esterna, destra***16A max. | Policarbonato (PC)
L: 20,3 cm | La: 11,9 cm | H: 3,3 cm

● nero	Articolo	1002651	39,00 EUR
○ bianco		1002653	39,00 EUR

**Adattatore meccanico sostegno apparecchi**Alluminio/plastica
L: 6,6 cm | La: 6,6 cm | H: 3,1 cm

● nero	Articolo	175210	15,40 EUR
○ bianco		1001395	15,40 EUR

**Raccordo a T, DALI, terra interna, sinistra***16A max. | Policarbonato (PC)
L: 20,3 cm | La: 11,9 cm | H: 3,3 cm

● nero	Articolo	1004941	39,00 EUR
○ bianco		1004942	39,00 EUR

**Copertura**Policarbonato (PC)
L: 200 cm La: 2,2 cm H: 0,75 cm

● nero	Articolo	1004939	7,55 EUR
○ bianco		1004940	7,55 EUR

**Raccordo a T, DALI, terra interna, destra***16A max. | Policarbonato (PC)
L: 20,3 cm | La: 11,9 cm | H: 3,3 cm

● nero	Articolo	1004943	39,00 EUR
○ bianco		1004944	39,00 EUR

**Calotta di chiusura**Plastica
L: 3,5 cm La: 3,3 cm H: 3,2 cm

● nero	Articolo	175060	2,00 EUR
○ bianco		1001380	2,00 EUR

**Raccordo a X, DALI***16A max. | Policarbonato (PC) / policarbonato (PC)
L: 20,3 cm | La: 20,3 cm | H: 3,3 cm

● nero	Articolo	1002655	63,00 EUR
○ bianco		1002656	63,00 EUR

**Barra di sospensione**Alluminio/plastica
L: 100 cm, rosone Ø: 4 cm H: 4,5 cm
Carico meccanico massimo: 10 kg

● nero	Articolo	175160	32,50 EUR
○ bianco		1001390	32,50 EUR

**Raccordo longitudinale, alimentazione, DALI***16A max. | Policarbonato (PC)
L: 20,3 cm | La: 3,5 cm | H: 3,3 cm

● nero	Articolo	1002643	33,25 EUR
○ bianco		1002644	33,25 EUR

**Staffa di accoppiamento**Alluminio
L: 18,2 cm | La: 3,3 cm | H: 2,1 cm

● nero	Articolo	175180	11,90 EUR
○ bianco		1001392	11,90 EUR

**Raccordo longitudinale, DALI**16A max. | Policarbonato (PC)
L: 10,6 cm | La: 2,5 cm | H: 2,8 cm

● nero	Articolo	1002641	10,10 EUR
○ bianco		1002642	10,10 EUR

**Adattatore meccanico con gancio**Plastica/acciaio
H: 5,2 cm
carico meccanico massimo: 10 kg

● nero	Articolo	175190	2,70 EUR
○ bianco		1001393	2,70 EUR

**Raccordo flessibile, DALI**16A max. | Policarbonato (PC)
L: 28,5 cm | La: 3,5 cm | H: 3,2 cm

● nero	Articolo	1002645	54,00 EUR
○ bianco		1002646	54,00 EUR

**Rosone a plafone/parete, DALI**16A max. | Policarbonato (PC)
H: 3,5 cm Ø: 14,3 cm

● nero	Articolo	1004684	37,75 EUR
○ bianco		1004685	37,75 EUR

**Raccordo di isolamento**Plastica
L: 6,8 cm | La: 3,1 cm | H: 2,6 cm

● nero	Articolo	175080	7,65 EUR
○ bianco		1001382	7,65 EUR

**Set cavo di sospensione (2 pezzi)**Acciaio inox/ottone
L: 500 cm
carico meccanico massimo: 10 kg

● nichel	Articolo	1002845	41,75 EUR
----------	----------	---------	-----------

**Clip di fissaggio, DALI**Acciaio
L: 4 cm | La: 3,4 cm | H: 1,25 cm

● nero	Articolo	1002657	7,65 EUR
○ bianco		1002658	7,65 EUR

* con possibilità di alimentazione





NEW

S-TRACK

Binario trifase, posa a incasso, DALI

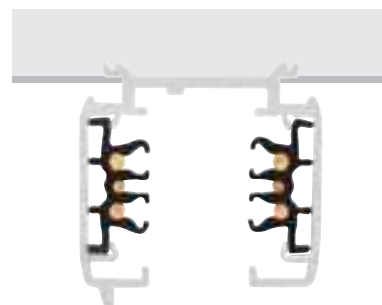

	1 m	1 m	2 m	2 m
Tensione nominale (V)	220-250V ~50/60Hz	220-250V ~50/60Hz	220-250V ~50/60Hz	220-250V ~50/60Hz
Corrente massima (A)	16	16	16	16
Carico meccanico massimo (Kg)	30 kg	30 kg	30 kg	30 kg
Colore	● nero	○ bianco	● nero	○ bianco
Materiale	Alluminio	Alluminio	Alluminio	Alluminio
L x La x A (cm)	100 x 5,6 x 3,2	100 x 5,6 x 3,2	200 x 5,6 x 3,2	200 x 5,6 x 3,2
Articolo	1006511 ●	1006512 ●	1006513 ●	1006514 ●
EUR	53,00	53,00	96,00	96,00
	3 m	3 m	4 m	4 m
Tensione nominale (V)	220-250V ~50/60Hz	220-250V ~50/60Hz	220-250V ~50/60Hz	220-250V ~50/60Hz
Corrente massima (A)	16	16	16	16
Carico meccanico massimo (Kg)	30 kg	30 kg	30 kg	30 kg
Colore	● nero	○ bianco	● nero	○ bianco
Materiale	Alluminio	Alluminio	Alluminio	Alluminio
L x La x A (cm)	300 x 5,6 x 3,2	300 x 5,6 x 3,2	400 x 5,6 x 3,2	400 x 5,6 x 3,2
Articolo	1006515 ●	1006516 ●	1006517 ●	1006518 ●
EUR	137,00	137,00	217,00	217,00



S-TRACK

Binario trifase, posa a incasso, DALI
Guida alla progettazione e panoramica accessori

Vista dei componenti dall'alto

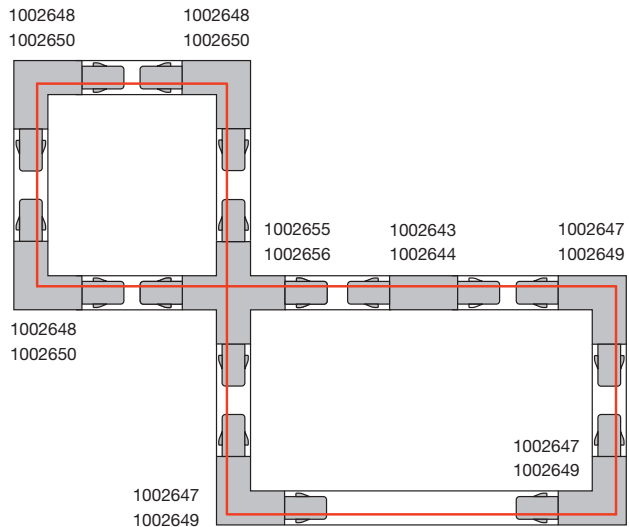
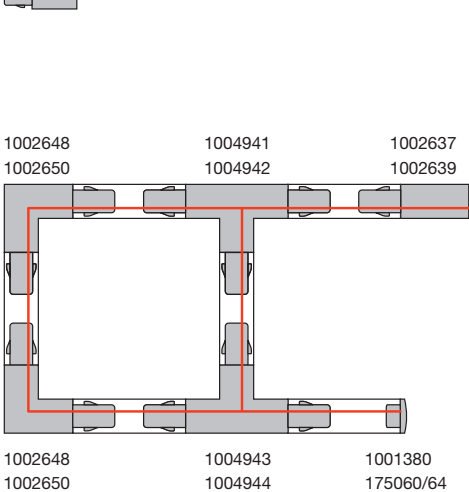
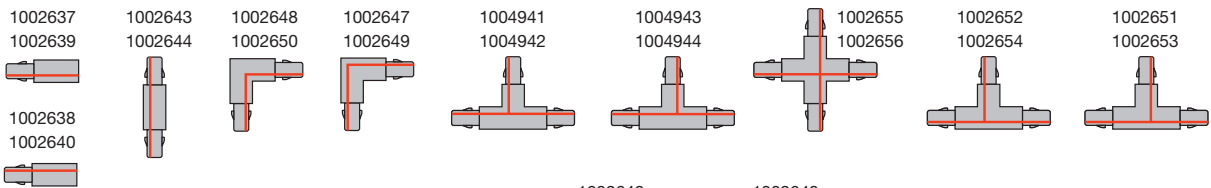
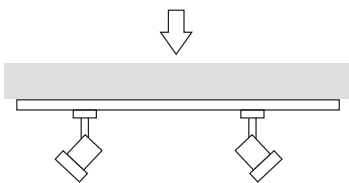

**Testata alimentazione, DALI, terra a destra**16A max. | Policarbonato (PC)
L: 14,7 cm | La: 5,6 cm | H: 3,3 cm● nero Articolo **1006519** **33,25 EUR**
○ bianco **1006520** **33,25 EUR****Raccordo a T, DALI, terra esterna, destra***16A max. | Policarbonato (PC)
L: 20,3 cm | La: 13 cm | H: 3,3 cm● nero Articolo **1006533** **39,00 EUR**
○ bianco **1006534** **39,00 EUR****Testata alimentazione, DALI, terra a sinistra**16A max. | Policarbonato (PC)
L: 14,7 cm | La: 5,6 cm | H: 3,3 cm● nero Articolo **1006521** **33,25 EUR**
○ bianco **1006522** **33,25 EUR****Raccordo a T, DALI, terra interna, sinistra***16A max. | Policarbonato (PC)
L: 20,3 cm | La: 13 cm | H: 3,3 cm● nero Articolo **1006527** **39,00 EUR**
○ bianco **1006528** **39,00 EUR****Raccordo a L, DALI, terra esterna***16A max. | Policarbonato (PC)
L: 13 cm | La: 13 cm | H: 3,3 cm● nero Articolo **1006525** **33,25 EUR**
○ bianco **1006526** **33,25 EUR****Raccordo a X, DALI***16A max. | Policarbonato (PC)
L: 20,3 cm | La: 20,3 cm | H: 3,3 cm● nero Articolo **1006535** **63,00 EUR**
○ bianco **1006536** **63,00 EUR****Raccordo a L, DALI, terra interna***16A max. | Policarbonato (PC)
L: 13 cm | La: 13 cm | H: 3,3 cm● nero Articolo **1006523** **33,25 EUR**
○ bianco **1006524** **33,25 EUR****Raccordo longitudinale alimentazione, DALI***16A max. | Policarbonato (PC)
L: 20,3 cm | La: 5,6 cm | H: 3,3 cm● nero Articolo **1006537** **33,25 EUR**
○ bianco **1006538** **33,25 EUR****Raccordo a T, DALI, terra esterna, sinistra***16A max. | Policarbonato (PC)
L: 20,3 cm | La: 13 cm | H: 3,3 cm● nero Articolo **1006529** **39,00 EUR**
○ bianco **1006530** **39,00 EUR****Raccordo longitudinale, DALI**16A max. | Policarbonato (PC)
L: 10,6 cm | La: 2,5 cm | H: 2,8 cm● nero Articolo **1002641** **10,10 EUR**
○ bianco **1002642** **10,10 EUR****Raccordo a T, DALI, terra interna, destra***16A max. | Policarbonato (PC)
L: 20,3 cm | La: 13 cm | H: 3,3 cm● nero Articolo **1006531** **39,00 EUR**
○ bianco **1006532** **39,00 EUR****Calotta di chiusura, DALI**Policarbonato (PC)
L: 4,79 cm | La: 5,6 cm● nero Articolo **1006539** **2,00 EUR**
○ bianco **1006540** **2,00 EUR**

*con possibilità di alimentazione





EUTRAC®

Binario trifase, posa in superficie

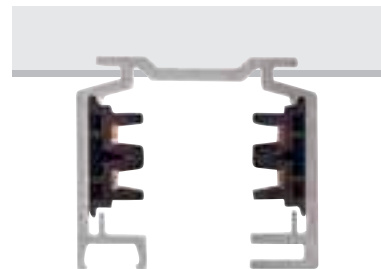

	1 m	1 m	1 m
Tensione nominale (V)	220-240V ~50/60Hz	220-240V ~50/60Hz	220-240V ~50/60Hz
Corrente massima (A)	16	16	16
Colore	● nero	○ bianco	● grigio
Materiale	Alluminio/plastica	Alluminio/plastica	Alluminio/plastica
L x La x A (cm)	100 x 3,6 x 3,2	100 x 3,6 x 3,2	100 x 3,6 x 3,2
Articolo	145100	1001510	145102
EUR	49,50	49,50	49,50
	2 m	2 m	2 m
Tensione nominale (V)	220-240V ~50/60Hz	220-240V ~50/60Hz	220-240V ~50/60Hz
Corrente massima (A)	16	16	16
Colore	● nero	○ bianco	● grigio
Materiale	Alluminio/plastica	Alluminio/plastica	Alluminio/plastica
L x La x A (cm)	200 x 3,6 x 3,2	200 x 3,6 x 3,2	200 x 3,6 x 3,2
Articolo	145200	1001511	145202
EUR	90,00	90,00	90,00
	3 m	3 m	3 m
Tensione nominale (V)	220-240V ~50/60Hz	220-240V ~50/60Hz	220-240V ~50/60Hz
Corrente massima (A)	16	16	16
Colore	● nero	○ bianco	● grigio
Materiale	Alluminio/plastica	Alluminio/plastica	Alluminio/plastica
L x La x A (cm)	300 x 3,6 x 3,2	300 x 3,6 x 3,2	300 x 3,6 x 3,2
Articolo	145300	1001512	145302
EUR	141,00	141,00	141,00

EUTRAC®

Binario trifase, posa in superficie
 Guida alla progettazione e panoramica accessori

Vista dei componenti dall'alto

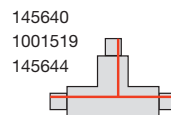
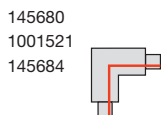
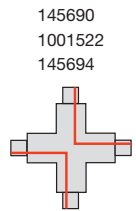
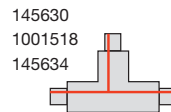
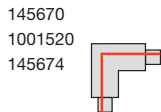
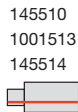
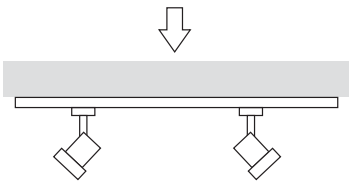

Esempio | terra esterna

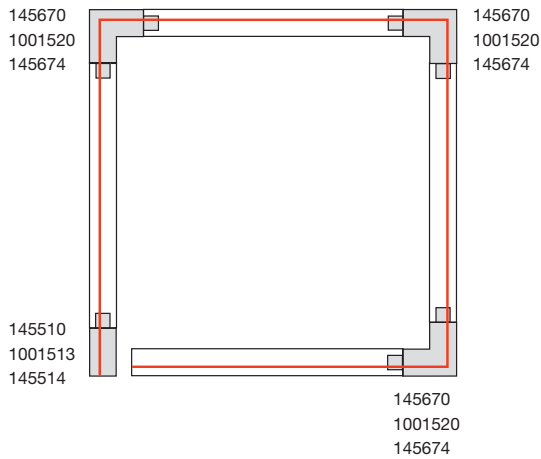

Esempio | terra interna

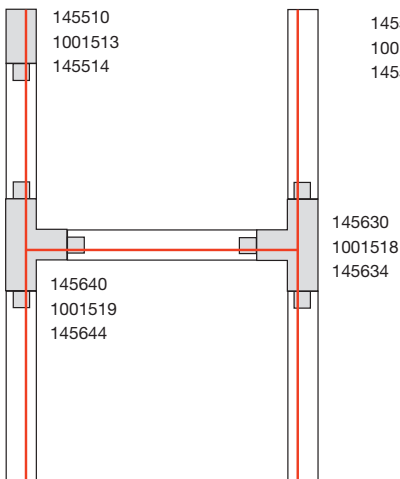
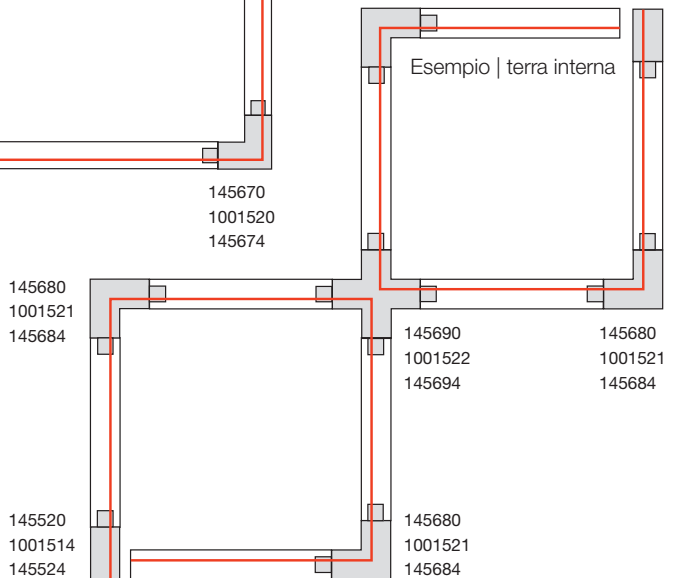



 <p>Testata alimentazione, terra a sinistra 16A max. Plastica L: 11,2 cm La: 3,6 cm H: 3,2 cm</p> <ul style="list-style-type: none"> ● nero Articolo 145510 19,70 EUR ○ bianco 1001513 19,70 EUR ● grigio 145514 19,70 EUR 	 <p>Gancio di accoppiamento Plastica L: 10 cm La: 3,6 cm H: 1,9 cm</p> <ul style="list-style-type: none"> ● nero Articolo 145600 21,75 EUR ○ bianco 1001523 21,75 EUR ● grigio 145604 21,75 EUR
 <p>Testata alimentazione, terra a destra 16A max. Plastica L: 11,2 cm La: 3,6 cm H: 3,2 cm</p> <ul style="list-style-type: none"> ● nero Articolo 145520 19,70 EUR ○ bianco 1001514 19,70 EUR ● grigio 145524 19,70 EUR 	 <p>Raccordo flessibile 16A max. Plastica L: 30,7 cm La: 3,6 cm H: 3,2 cm</p> <ul style="list-style-type: none"> ● nero Articolo 145580 89,00 EUR ○ bianco 1001524 89,00 EUR ● grigio 145584 89,00 EUR
 <p>Testata alimentazione centrale 16A max. Plastica L: 13 cm La: 3,6 cm H: 3,6 cm</p> <ul style="list-style-type: none"> ● nero Articolo 145530 44,75 EUR ○ bianco 1001515 44,75 EUR ● grigio 145534 44,75 EUR 	 <p>Presca con adattatore trifase 6,3A max. Plastica L: 9,6 cm La: 6,5 cm H: 9 cm</p> <ul style="list-style-type: none"> ● nero Articolo 145700 94,00 EUR ○ bianco 1001525 94,00 EUR
 <p>Raccordo longitudinale alimentazione* 16A max. Plastica L: 19,2 cm La: 3,6 cm H: 3,2 cm</p> <ul style="list-style-type: none"> ● nero Articolo 145660 78,00 EUR ○ bianco 1001517 78,00 EUR ● grigio 145664 78,00 EUR 	 <p>Adattatore trifase 10A max. Plastica L: 9,6 cm La: 3,5 cm H: 4,5 cm carico meccanico massimo: 5 kg</p> <ul style="list-style-type: none"> ● nero Articolo 145990 19,70 EUR ○ bianco 1001542 19,70 EUR ● grigio 145994 19,70 EUR
 <p>Raccordo longitudinale* 16A max. Plastica L: 5,8 cm La: 1,5 cm H: 2,6 cm</p> <ul style="list-style-type: none"> ● nero Articolo 145560 19,70 EUR ○ bianco 1001516 19,70 EUR ● grigio 145564 19,70 EUR 	 <p>Clip per barra di sospensione Alluminio L: 5 cm La: 3,6 cm H: 1,9 cm Filettatura M13</p> <ul style="list-style-type: none"> ● nero Articolo 145730 11,40 EUR ○ bianco 1001530 11,40 EUR ● grigio 145734 11,40 EUR
 <p>Raccordo a L, terra interna* 16A max. Plastica L: 15 cm La: 15 cm H: 3,2 cm</p> <ul style="list-style-type: none"> ● nero Articolo 145680 65,00 EUR ○ bianco 1001521 65,00 EUR ● grigio 145684 65,00 EUR 	 <p>Rosone, plafone/parete 16A max. Plastica H: 3,1 cm Ø: 11,9 cm</p> <ul style="list-style-type: none"> ● nero Articolo 145830 104,00 EUR ○ bianco 1001526 104,00 EUR ● grigio 145834 104,00 EUR
 <p>Raccordo a L, terra esterna* 16A max. Plastica L: 15 cm La: 15 cm H: 3,2 cm</p> <ul style="list-style-type: none"> ● nero Articolo 145670 65,00 EUR ○ bianco 1001520 65,00 EUR ● grigio 145674 65,00 EUR 	 <p>Calotta di chiusura Plastica L: 3,6 cm La: 1,7 cm H: 3,2 cm</p> <ul style="list-style-type: none"> ● nero Articolo 145590 4,00 EUR ○ bianco 1001527 4,00 EUR ● grigio 145594 4,00 EUR
 <p>Raccordo a T, terra interna sinistra* 16A max. Plastica L: 26 cm La: 18,5 cm H: 3,2 cm</p> <ul style="list-style-type: none"> ● nero Articolo 145630 89,00 EUR ○ bianco 1001518 89,00 EUR ● grigio 145634 89,00 EUR 	 <p>Barra di sospensione 60 cm Plastica/acciaio H: 62 cm Ø: 7 cm Filettatura M13</p> <ul style="list-style-type: none"> ● nero Articolo 145720 39,00 EUR ○ bianco 1001529 39,00 EUR ● grigio 145724 39,00 EUR
 <p>Raccordo a T, terra interna, destra* 16A max. Plastica L: 26 cm La: 18,5 cm H: 3,2 cm</p> <ul style="list-style-type: none"> ● nero Articolo 145640 89,00 EUR ○ bianco 1001519 89,00 EUR ● grigio 145644 89,00 EUR 	 <p>Barra di sospensione 120 cm Plastica/acciaio H: 122 cm Ø: 7 cm Filettatura M13</p> <ul style="list-style-type: none"> ● nero Articolo 145710 44,75 EUR ○ bianco 1001528 44,75 EUR ● grigio 145714 44,75 EUR
 <p>Raccordo a X* 16A max. Plastica L: 26 cm La: 26 cm H: 3,2 cm</p> <ul style="list-style-type: none"> ● nero Articolo 145690 130,00 EUR ○ bianco 1001522 130,00 EUR ● grigio 145694 130,00 EUR 	 <p>Set cavo di sospensione (2 pezzi) Acciaio inox/ottone L: 500 cm carico meccanico massimo: 10 kg</p> <ul style="list-style-type: none"> ● nichel Articolo 1002845 41,75 EUR

*con possibilità di alimentazione





EUTRAC®

Binario trifase, posa a incasso, accessori

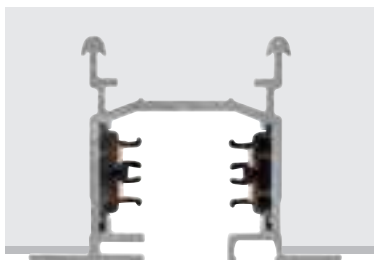

	2 m	3 m
Tensione nominale (V)	220-240V ~50/60Hz	220-240V ~50/60Hz
Corrente massima (A)	16	16
Colore	○ bianco	○ bianco
Materiale	Alluminio/plastica	Alluminio/plastica
L x La x A (cm)	200 x 5,9 x 4,1	300 x 5,9 x 4,1
Articolo	1001531	1001532
EUR	121,00	201,00



Testata alimentazione, terra a sinistra

16A max. | Plastica / Acciaio
L: 12,2 cm | La: 6 cm | H: 3,4 cm

○ bianco

Articolo **1001533** **32,50 EUR**



Calotta di chiusura

Plastica
L: 2,7 cm | La: 6 cm | H: 3,2 cm

○ bianco

Articolo **1001538** **7,65 EUR**



Testata alimentazione, terra a destra

16A max. | Plastica / Acciaio
L: 12,2 cm | La: 6 cm | H: 3,4 cm

○ bianco

Articolo **1001534** **32,50 EUR**



Raccordo longitudinale con stabilizzatore

16A max. | Plastica / Acciaio
L: 6,2 cm | La: 2,5 cm | H: 2,7 cm

○ bianco

Articolo **1001539** **27,25 EUR**



Raccordo a L, terra esterna, con possibilità di alimentazione

16A max. | Plastica / Acciaio
L: 16 cm | La: 6 cm | H: 3,2 cm

○ bianco

Articolo **1001536** **78,00 EUR**



Clip di fissaggio a molla (6 pezzi)

Acciaio
L: 2 cm | La: 1 cm | H: 2,5 cm

● grigio

Articolo **145551** **13,20 EUR**



Raccordo a L, terra interna, con possibilità di alimentazione

16A max. | Plastica / Acciaio
L: 16 cm | La: 6 cm | H: 3,2 cm

○ bianco

Articolo **1001537** **78,00 EUR**



Adattatore trifase

Plastica
L: 9,6 cm La: 3,5 cm H: 4,5 cm
carico meccanico massimo: 5 kg

○ bianco

Articolo **1001542** **19,70 EUR**

1007655 543





TS V
Trifase

TS V
Trifase

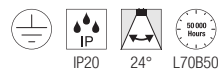
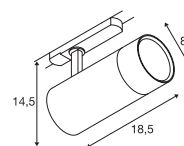
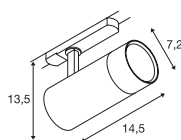

220-240V ~50/60Hz | 250/350/500mA
Potenza assorbita: 20W
Materiale: alluminio/policarbonato (PC)

220-240V ~50/60Hz | 600/750/mA
Potenza assorbita: 35W
Materiale: alluminio/policarbonato (PC)



Down	1800lm	2700K
	1980lm	3000K
	1920lm	4000K

Down	3090lm	2700K
	3470lm	3000K
	3300lm	4000K

Versione	Articolo	EUR
● nero	1007655	159,00
○ bianco	1007654	159,00

Versione	Articolo	EUR
● nero	1007657	179,00
○ bianco	1007656	179,00

1007646 545





NOBLO® SPOT
Trifase, PHASE

NOBLO® SPOT
Trifase, PHASE

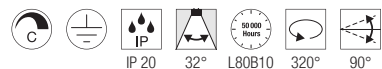
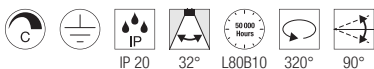
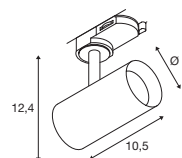
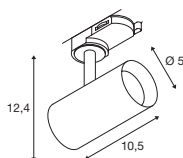

220-240V ~50/60Hz | 150mA
Potenza assorbita: 6,2W
Materiale: alluminio/policarbonato (PC)

220-240V ~50/60Hz | 150mA
Potenza assorbita: 6,2W
Materiale: alluminio/policarbonato (PC)



Down 740lm | 2700K

Down 750lm | 3000K

Versione	Articolo	EUR
● nero	1007644	75,00
○ bianco	1007645	75,00

Versione	Articolo	EUR
● nero	1007646	75,00
○ bianco	1007647	75,00

1007649 547





NOBLO® SPOT Trifase, PHASE



NOBLO® SPOT Trifase, PHASE

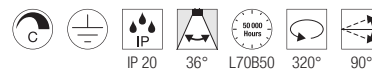
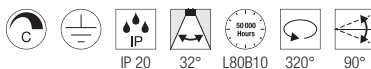
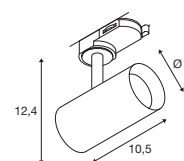
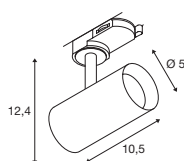

220-240V ~50/60Hz | 150mA
Potenza assorbita: 6,2W
Materiale: alluminio/policarbonato (PC)

220-240V ~50/60Hz | 350mA
Potenza assorbita: 8,4W
Materiale: alluminio/policarbonato (PC)



Down 760lm | 4000K



Down 30lm | 2000K - 450lm | 3000K

Versione	Articolo	EUR
● nero	1007648	75,00
○ bianco	1007649	75,00

Versione	Articolo	EUR
● nero	1007355	90,00
○ bianco	1007356	90,00

1007597 549

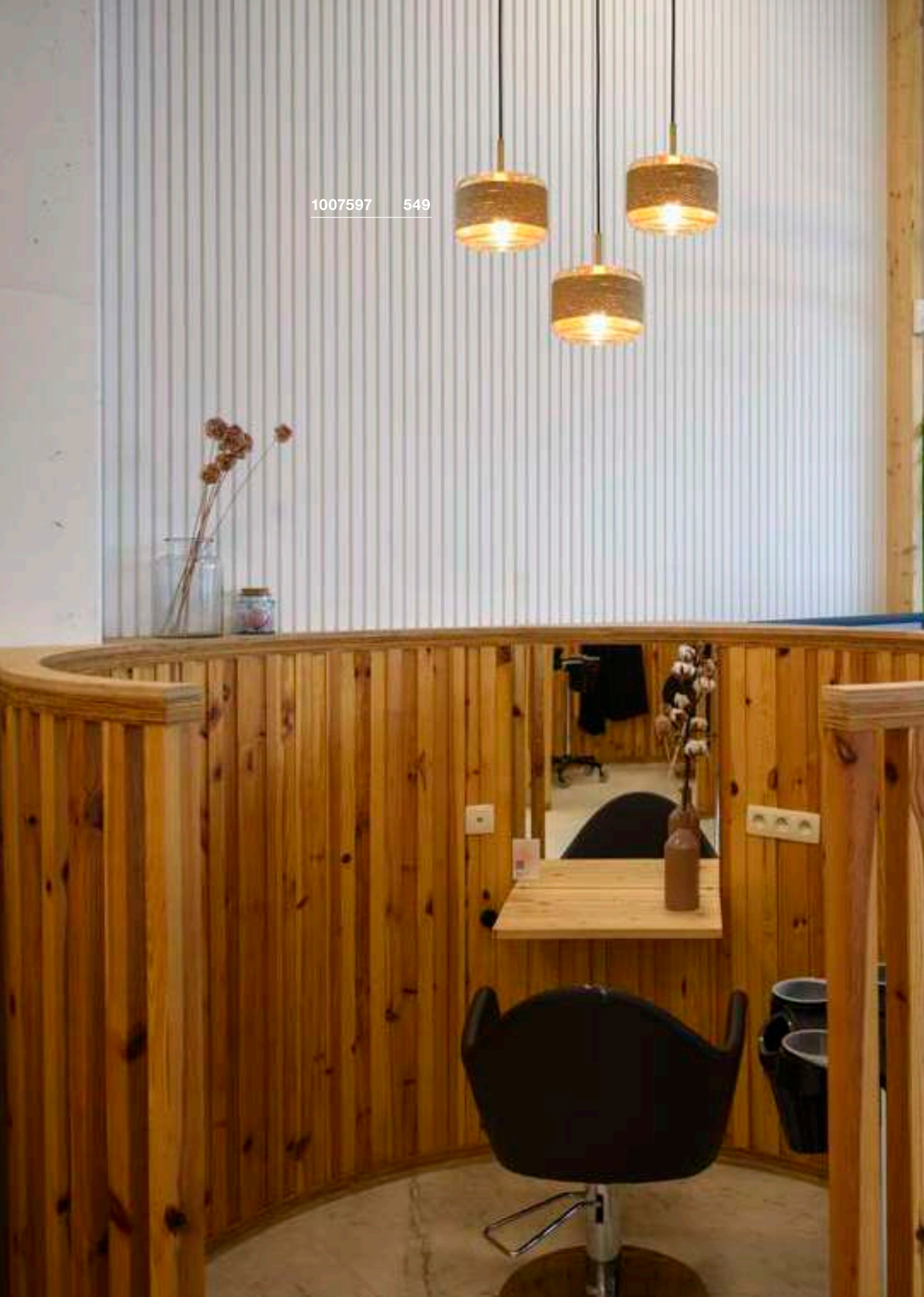



PANTILO ROPE 19 PD, E27

NEW

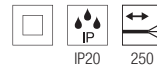
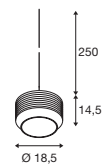

200-240V ~50/60Hz
Materiale: acciaio/vetro/canapa

- Cavo con terminale aperto
- Adattatore trifase da acquistare a parte

**SECRET
INSIDE** <15
W

Attacco: 1xE27

Ø max.: 10 cm

L: 11 cm

Versione	Articolo	EUR
● ambra/oro	1007597	● 199,00
● antracite/argento	1007596	● 199,00



A60 | 7,5W | 180°
2700K | 720lm | Classe=F
8kWh/1000h



Articolo: **1005305** | **19,00 EUR**

SIGHT TRACK Trifase, DALI

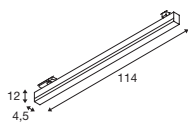

220-240V ~50/60Hz | 700mA
Potenza assorbita: 39W
Materiale: alluminio/acrilico



Down 3000lm | 3000K | 3000lm | 4000K

Versione	Articolo	EUR
● nero	1005397	375,00
○ bianco	1005399	375,00

SIGHT TRACK Trifase

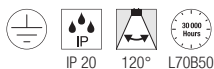
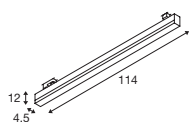

220-240V ~50/60Hz | 700mA
Potenza assorbita: 37W
Materiale: alluminio/acrilico



Down 3000lm | 3000K | 3000lm | 4000K

Versione	Articolo	EUR
● nero	1005400	309,00
○ bianco	1005401	309,00
● grigio	1005402	309,00

1005400 550





1005399 551

SIGHT MOVE Trifase, DALI

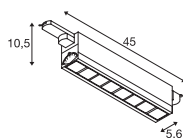

220-240V ~50/60Hz | 350mA
Potenza assorbita: 26W
Materiale: alluminio/polimetilmetacrilato (PMMA)



Down 2700lm | 3000K
3100lm | 4000K

Versione	Articolo	EUR
● nero 2700lm 3000K	1004690	255,00
○ bianco 2700lm 3000K	1004691	255,00
● nero 3100lm 4000K	1004692	255,00
○ bianco 3100lm 4000K	1004693	255,00

SIGHT MOVE Trifase

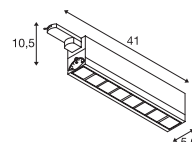

220-240V ~50/60Hz | 350mA
Potenza assorbita: 26W
Materiale: alluminio/polimetilmetacrilato (PMMA)



Down 2700lm | 3000K
3100lm | 4000K

Versione	Articolo	EUR
● nero 2700lm 3000K	1004686	182,00
○ bianco 2700lm 3000K	1004687	182,00
● nero 3100lm 4000K	1004688	182,00
○ bianco 3100lm 4000K	1004689	182,00

PARA CONE GL
Trifase, GU10

PARA CONE GL
PD, GU10

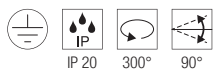
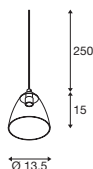
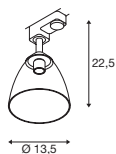

220-240V ~50/60Hz
Materiale: alluminio/vetro



Attacco: 1xGU10

Versione	Articolo	EUR
● nero	1006157	102,00
○ bianco	1006158	102,00



LED GU10 51mm | 3,2W
2700K | 270lm | Classe=G



Articolo: 1006321 | 48,00 EUR

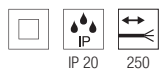

220-240V ~50/60Hz
Materiale: alluminio/vetro

- Cavo con terminale aperto
- Adattatore trifase da acquistare a parte



Attacco: 1xGU10

Versione	Articolo	EUR
● nero	1006159	84,00
○ bianco	1006160	84,00



LED GU10 51mm | 3,2W
2700K | 270lm | Classe=G



Articolo: 1006321 | 48,00 EUR

1006157 552



1006160 552

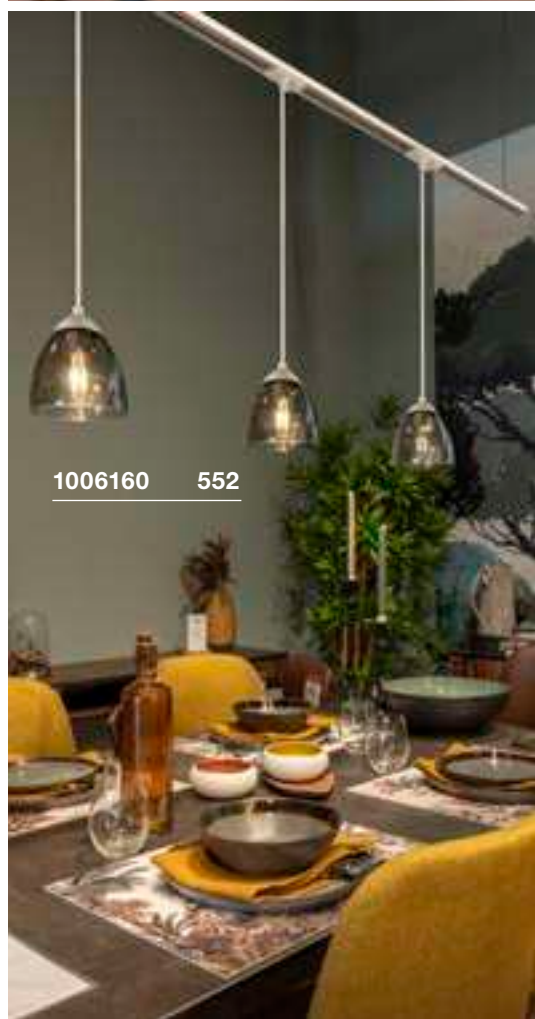



PARA CONE 14
Trifase, QPAR51

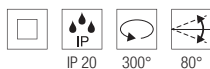
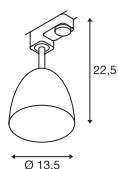

220-240V ~50/60Hz
Materiale: acciaio



Attacco: 1xGU10

Versione	Articolo	EUR
● nero	1002876	86,00
○ bianco	1002877	86,00
● rame	1002878	89,00



LED GU10 51mm | 3,2W
2700K | 270lm | Classe=G



Articolo: 1006321 | 48,00 EUR

PARA CONE 14
Trifase, PD, QPAR51

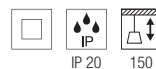
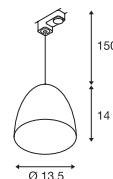

220-240V ~50/60Hz
Materiale: alluminio



Attacco: 1xGU10

Versione	Articolo	EUR
● nero	153140	117,00
○ bianco	153141	117,00
● rame	1002686	124,00



LED GU10 51mm | 3,2W
2700K | 270lm | Classe=G



Articolo: 1006321 | 48,00 EUR



153141 **553**

FORCHINI M 40 TRACK
Trifase, PD, E27

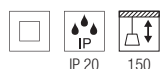
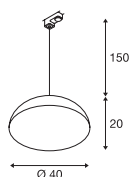

220-240V ~50/60Hz
Materiale: alluminio/acciaio

- Adattatore trifase incluso



Attacco: 1xE27 Ø max.: 6,8 cm L: 15,2 cm

Versione	Articolo	EUR
●● nero/oro	153130	233,00



A60 | 7,5W | 180°
2700K | 720lm | Classe=F
8kWh/1000h



Articolo: 1005305 | 19,00 EUR

153130 554



152750 555





EURO CUBE Trifase

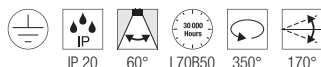
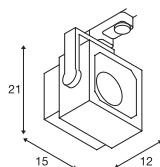

220-240V ~50/60Hz
Potenza assorbita: 26W
Materiale: alluminio



Down 2470lm | 3000K
2740lm | 4000K

Versione	Articolo	EUR
● nero		
2470lm 3000K	152750	260,00
○ bianco		
2470lm 3000K	152751	260,00
● nero		
2740lm 4000K	152780	260,00
○ bianco		
2740lm 4000K	152781	260,00

EURO SPOT TRACK Trifase, QPAR111

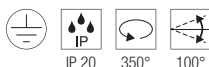
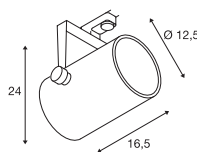

220-240V ~50/60Hz
Materiale: alluminio



Attacco: 1xGU10

Versione	Articolo	EUR
● nero	153420	106,00
○ bianco	153421	106,00



QPAR111 | 12,5W | 30°
2700K | 950lm | Classe=F
13kWh/1000h

Articolo: **1005276** | **49,50 EUR**



EURO SPOT TRACK Trifase, QPAR51

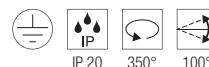
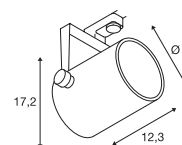

220-240V ~50/60Hz
Materiale: alluminio



Attacco: 1xGU10

Versione	Articolo	EUR
● nero	153850	84,00
○ bianco	153851	84,00



LED GU10 51mm | 6W | 38°
2700K | 450lm | Classe=F
6kWh/1000h

Articolo: **1005077** | **7,50 EUR**



ALTRA DICE TRACK

Trifase, QPAR51

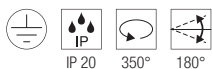
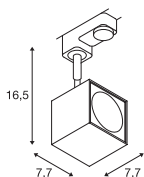

220-240V ~50/60Hz
Materiale: alluminio



Attacco: 1xGU10 max. Ø: 5,1 cm L: 5,7 cm

Versione	Articolo	EUR
● nero	152320	96,00
○ bianco	152321	96,00



LED GU10 51mm | 6W | 36°
2200-2700K | 360lm | Classe=G
6kWh/1000h



Articolo: 1005273 | 9,99 EUR

152320 556

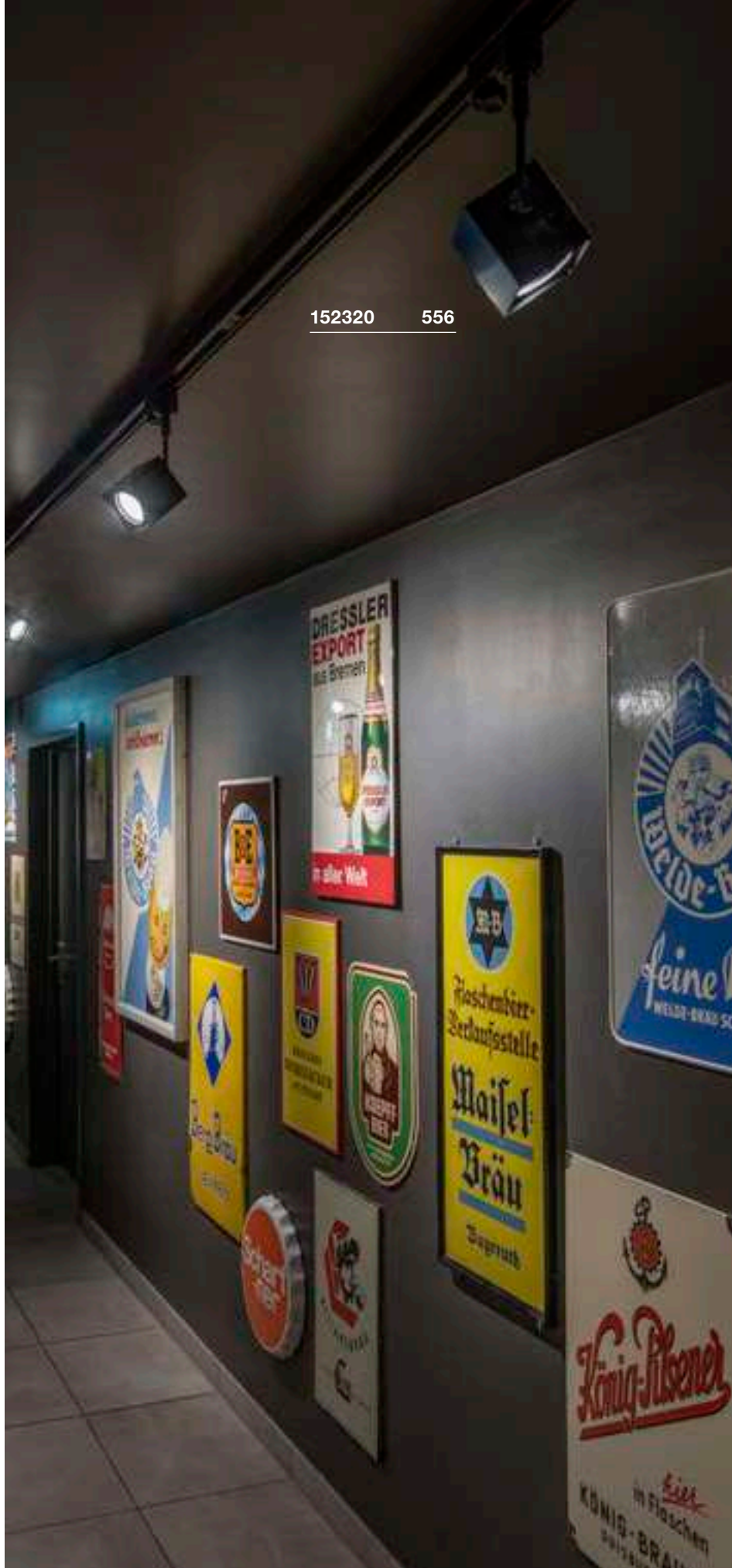



PURI TRACK
Trifase, QPAR51

PURI TRACK GLASS
Trifase, QPAR51

153560 557

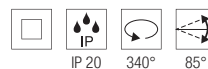
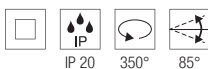
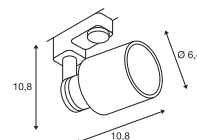
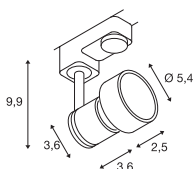

220-240V ~50/60Hz
Materiale: alluminio/polycarbonato (PC)

220-240V ~50/60Hz
Materiale: alluminio/plastica

- Anello decorativo incluso



Attacco: 1xGU10

Attacco: 1xGU10

Versione	Articolo	EUR
● nero	153560	35,75
○ bianco	153561	35,75
● grigio	153564	35,75

Versione	Articolo	EUR
● nero	1001871	45,00
○ bianco	1001872	45,00



LED GU10 51mm | 6W | 38°
2700K | 450lm | Classe=F
6kWh/1000h



Articolo: 1005075 | 7,50 EUR



LED GU10 51mm | 6W | 38°
2700K | 450lm | Classe=F
6kWh/1000h



Articolo: 1005077 | 7,50 EUR

MENSEN DIE ZICH ELKE DAG KUNNEN GEVEN.
ZIJ ZIJN DE MENSEN DIE IK BEWONDER.
ZE ZIJN ECHTE MENSEN.
Marco Ferreri
Success is geboren uit arrogantie.
Grootgheid komt uit nederigheid.

KALU TRACK LED
Trifase, PHASE

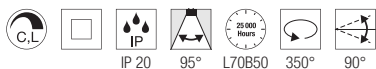
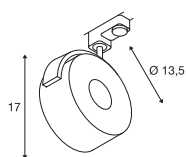

220-240V ~50/60Hz
Potenza assorbita: 13W
Materiale: alluminio



Down 970lm | 3000K

Versione	Articolo	EUR
● nero		
CRI80	152600	219,00
○ bianco		
CRI90	152601	219,00

KALU TRACK
Trifase, QPAR111

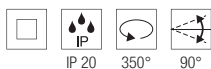
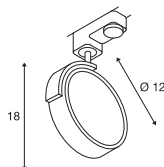

220-240V ~50/60Hz
Materiale: alluminio/plastica



Attacco: 1xGU10

Versione	Articolo	EUR
● nero	152610	89,00
○ bianco	152611	89,00



QPAR111 | 12.5W | 10°
3000K | 950lm | Classe=F
13kWh/1000h



Articolo: **1005278** | **55,00 EUR**

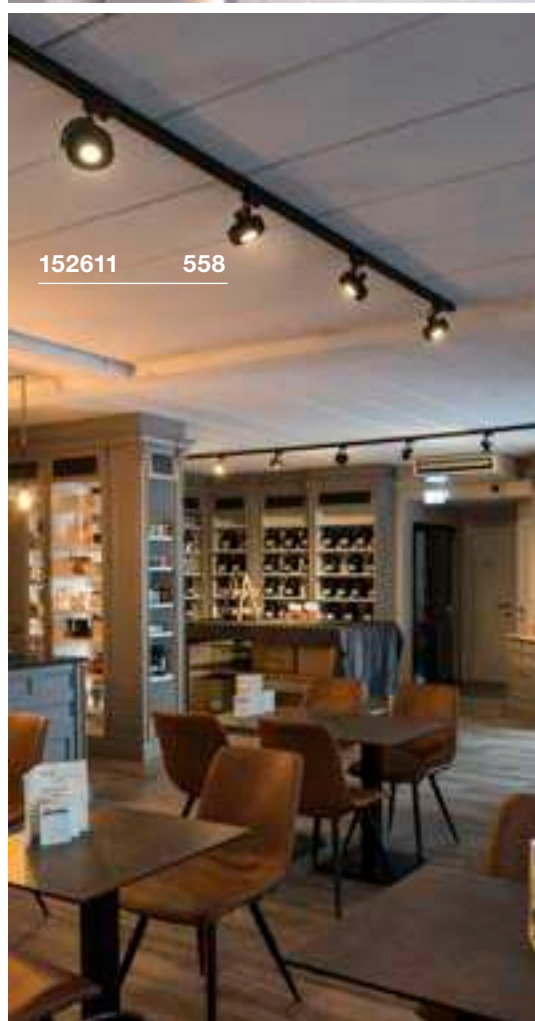

152601 558



BIMA
Trifase, single, QPAR51

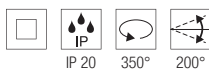
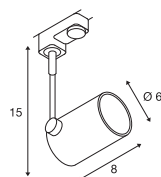

220-240V ~50/60Hz
Materiale: alluminio



Attacco: 1xGU10 max. Ø: 5,1 cm L: 5,7 cm

Versione	Articolo	EUR
● nero	152240	45,00
○ bianco	152241	45,00
● grigio	152242	45,00



LED GU10 51mm | 6W | 38°
2700K | 450lm | Classe=F
6kWh/1000h



Articolo: 1005077 | 7,50 EUR

INDOOR | SISTEMI TRIFASE



BIMA
Trifase, double, QPAR51

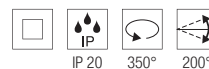
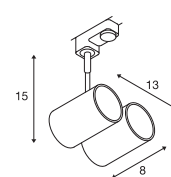

220-240V ~50/60Hz
Materiale: alluminio



Attacco: 2xGU10 max. Ø: 5,1 cm L: 5,7 cm

Versione	Articolo	EUR
● nero	152230	70,00
○ bianco	152231	70,00
● grigio	152232	70,00



LED GU10 51mm | 6W | 38°
2700K | 450lm | Classe=F
6kWh/1000h



Articolo: 1005075 | 7,50 EUR

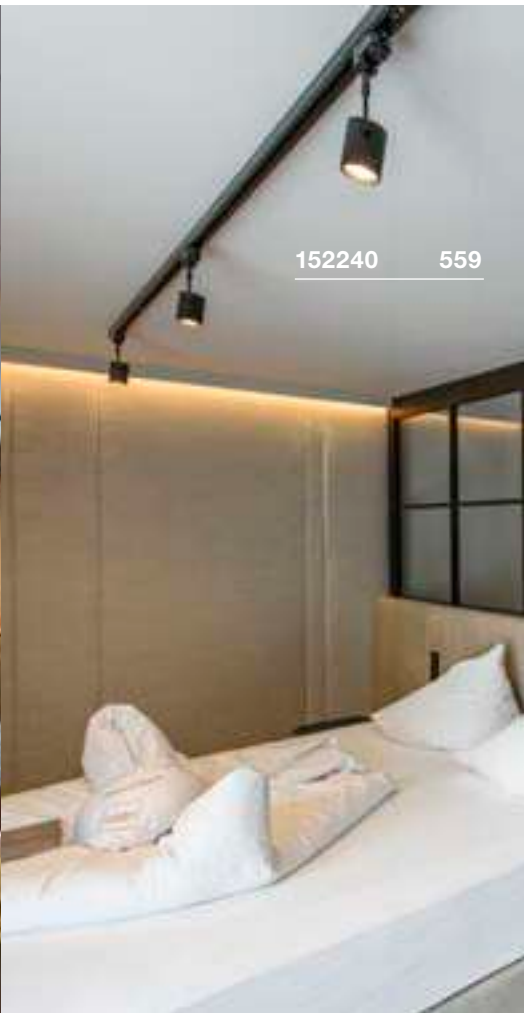

152240 559





HELIA 50 TRACK Trifase

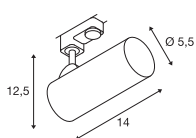

220-240V ~50/60Hz | 500mA
Potenza assorbita: 11W
Materiale: alluminio



Down 810lm | 3000K
880lm

Versione	Articolo	EUR
● nero		
810lm	152960	90,00
○ bianco		
880lm	152961	90,00

ENOLA C TRACK Trifase

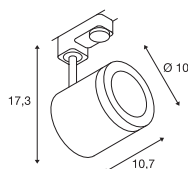

220-240V ~50/60Hz | 500mA
Potenza assorbita: 11W
Materiale: alluminio



Down 1040lm | 3000K

Versione	Articolo	EUR
● nero	152430	177,00
○ bianco	152431	177,00

AVO TRACK Trifase, QPAR51

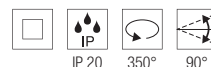
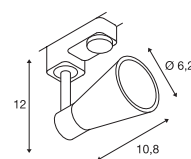

220-240V ~50/60Hz
Materiale: acciaio



Attacco: 1xGU10 max. Ø: 5,1 cm

Versione	Articolo	EUR
● nero	152640	44,50
○ bianco	152641	44,50



LED GU10 51mm | 6W | 38°
2700K | 450lm | Classe=F
6kWh/1000h



Articolo: **1005077** | **7,50 EUR**

CONFIGURA IL TUO SISTEMA A BINARIO

Un'illuminazione ben progettata è essenziale, soprattutto dove c'è molto da vedere. Grazie alla versatilità dell'illuminazione con il sistema a binario, si potranno mettere in mostra oggetti specifici. Sarà inoltre possibile apportare modifiche al progetto illuminotecnico in qualsiasi momento. Le barre trifase sono perfette per uffici, negozi, mostre e stand fieristici. Creeranno l'illuminazione perfetta e presenteranno prodotti e oggetti espositivi nella giusta luce. Le barre monofase sono particolarmente adatte per le abitazioni e inonderanno i tuoi spazi di una luce suggestiva. Grazie ai fori presenti, questi binari in alluminio possono essere fissati al soffitto in modo semplice e veloce. Puoi scegliere tra la versione ad incasso e quella con montaggio in superficie, entrambe sono disponibili in più colori.

A TE LA SCELTA:

- 1 Binario (S-TRACK, EUTRAC, monofase)
- 2 Tipo di montaggio (superficie/incasso)
- 3 Apparecchi
- 4 Opzioni di progettazione



FATTO!

SISTEMI A BINARI

S-TRACK
Trifase



EUTRAC
Trifase



MONOFASE



Incasso



Superficie



Plafone



Parete



Sospensione

Installazione

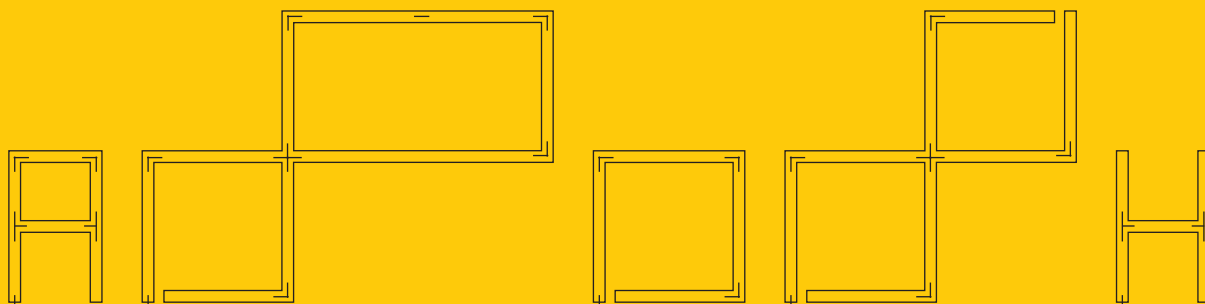

Varie opzioni di personalizzazione in base ai tuoi spazi

Utilizza anche il nostro configuratore di binari [slv.com](https://www.slv.com)



PROFILI



GRAZIA 10
PROFILO DA
SUPERFICIE | 567



GRAZIA 10
PROFILO DA
INCASSO | 567



GRAZIA 10 EDGE | 570

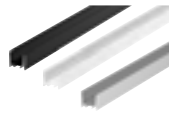

GRAZIA 20
PROFILO DA
SUPERFICIE | 573



GRAZIA 20
PROFILO DA
INCASSO | 573

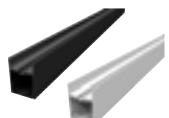

GRAZIA 60
PROFILO DA
SUPERFICIE | 577

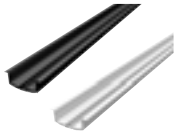

GRAZIA 60
PROFILO DA
INCASSO | 577



GRAZIA 10
ACCESSORI | 569



GRAZIA 10 EDGE
ACCESSORI | 571



GRAZIA 20
ACCESSORI |
574-575



GRAZIA 60
ACCESSORI |
578-579

LED STRIP



GRAZIA
FLEXSTRIP LED | 582



GRAZIA PRO
FLEXSTRIP LED | 583



GRAZIA PRO MAX
FLEXSTRIP | 585



GRAZIA PRO
FLEXSTRIP
TUNABLE WHITE | 587



GRAZIA PRO
FLEXSTRIP
RGBW | 589



GRAZIA IP
FLEXSTRIP | 591



GRAZIA
FLEXSTRIP LED
ACCESSORI | 582



GRAZIA PRO
FLEXSTRIP LED
ACCESSORI | 583



GRAZIA PRO MAX
FLEXSTRIP
ACCESSORI | 585



GRAZIA PRO
FLEXSTRIP
TUNABLE WHITE
ACCESSORI | 587



GRAZIA PRO
FLEXSTRIP RGBW
ACCESSORI | 589



GRAZIA 10

Profilo basso, posa in superficie

Materiale: alluminio
Larghezza: 1,75 cm, altezza: 1,1 cm,
Max. Larghezza LED strip in mm: 10
Copertura esclusa

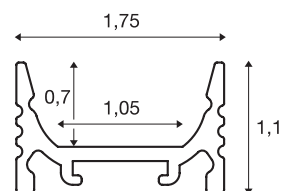

Lunghezza (cm)	Colore	Materiale	Articolo	EUR
200	● nero	Alluminio	1000462	29,00
	○ bianco		1000461	29,00

GRAZIA 10

Profilo standard, posa in superficie

Materiale: alluminio
Larghezza: 1,75 cm, altezza: 1,62 cm,
Max. Larghezza LED strip in mm: 10
Copertura esclusa

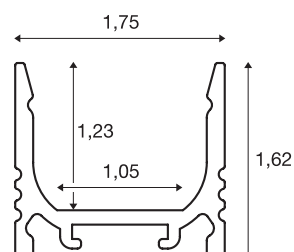

Lunghezza (cm)	Colore	Materiale	Articolo	EUR
200	● nero	Alluminio	1000465	29,00
	○ bianco		1000464	29,00

GRAZIA 10

Profilo a incasso

Materiale: alluminio
Larghezza: 3 cm, altezza: 1,62 cm,
Max. Larghezza LED strip in mm: 10
Copertura esclusa

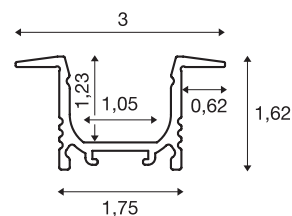

Lunghezza (cm)	Colore	Materiale	Articolo	EUR
200	● nero	Alluminio	1000459	32,00
	○ bianco		1000458	32,00



ACCESSORI

GRAZIA 10 Copertura



Descrizione	Colore	Lunghezza (cm)	Larghezza (cm)	Altezza (cm)	Materiale	Articolo	EUR
Copertura	○ smerigliato	200	1,58	0,4	Policarbonato (PC)	1000466	18,00
	○ opalescente				Polimetilmetacrilato (PMMA)	1000468	24,00
	○ satinato					1000469	24,00

GRAZIA 10 Clip di fissaggio



Descrizione	Colore	Larghezza (cm)	Altezza (cm)	Profondità (cm)	Materiale	Articolo	EUR
Clip di fissaggio	● cromo, 45°	1,62	1,62	1	Acciaio inox	1000489	5,40
	● cromo, non visibile	1,53	0,3	1	Acciaio Inox	1000487	4,30

Unità di imballaggio: 2 pezzi

GRAZIA 10 Calotte di chiusura per profilo da superficie

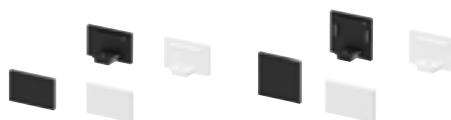

Descrizione	Colore	Lunghezza (cm)	Larghezza (cm)	Altezza (cm)	Materiale	Articolo	EUR
Calotte terminali	● nero, piatto	-	1,75	1,1	Alluminio	1000477	6,85
	○ bianco, piatto			1,1		1000476	6,85
Calotte terminali	● nero, standard	-	1,75	1,62	Alluminio	1000480	6,85
	○ bianco, standard			1,62		1000479	6,85

Unità di imballaggio: 2 pezzi

GRAZIA 10 Calotte di chiusura per profilo da incasso



Descrizione	Colore	Lunghezza (cm)	Larghezza (cm)	Altezza (cm)	Materiale	Articolo	EUR
Calotte terminali	● nero	-	3	1,62	Alluminio	1000474	6,85
	○ bianco					1000473	6,85

Unità di imballaggio: 2 pz.



GRAZIA 10 EDGE

Posa in superficie

Materiale: alluminio
 Larghezza: 1,95 cm, altezza: 1,95 cm
 max. Larghezza LED strip in mm: 10
 Copertura esclusa



IP 20

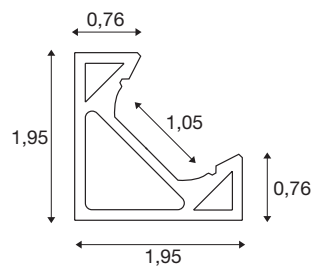
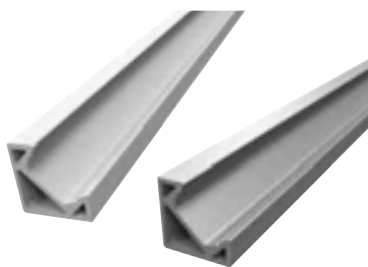

Lunghezza (cm)	Colore	Materiale	Articolo	EUR
200	<input type="radio"/> bianco	Alluminio	1004890	39,00
	<input checked="" type="radio"/> alluminio		1004889	39,00

ACCESSORI

GRAZIA 10 EDGE Copertura



Descrizione	Colore	Lunghezza (cm)	Larghezza (cm)	Altezza (cm)	Materiale	Articolo	EUR
Copertura	<input type="radio"/> smerigliato	200	1,58	0,4	Policarbonato (PC)	1000466	18,00
	<input type="radio"/> opalescente				Polimetilmetacrilato (PMMA)	1000468	24,00
	<input type="radio"/> satinato					1000469	24,00

GRAZIA 10 EDGE Calotta terminale



Descrizione	Colore	Lunghezza (cm)	Larghezza (cm)	Altezza (cm)	Materiale	Articolo	EUR
Calotta terminale	<input type="radio"/> bianco	2	0,7	2	ABS	1004894	2,25
	<input checked="" type="radio"/> alluminio					1004893	2,25

Unità di imballaggio: 2 pezzi

GRAZIA 10 EDGE Clip di fissaggio



Descrizione	Colore	Lunghezza (cm)	Larghezza (cm)	Altezza (cm)	Materiale	Articolo	EUR
Clip di fissaggio	<input checked="" type="radio"/> cromo	2,25	15	2,25	Acciaio Inox	1004895	4,25

Unità di imballaggio: 4 pezzi



GRAZIA 20

Profilo standard, posa in superficie

Materiale: alluminio
Larghezza: 3,5 cm; altezza: 3,2 cm
Max. Larghezza LED strip in mm: 20
Copertura esclusa

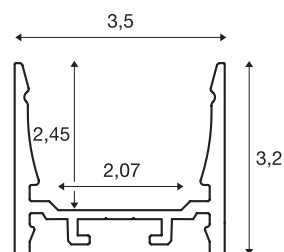
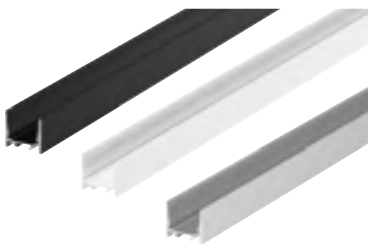

IP 20

Lunghezza (cm)	Colore	Materiale	Articolo	EUR
300	● nero	Alluminio	1000525	89,00
	○ bianco		1000524	89,00
	● alluminio		1000523	89,00

GRAZIA 20

Profilo basso, posa in superficie

Materiale: alluminio
Larghezza: 3,5 cm; altezza 2,2 cm
Max. Larghezza LED strip in mm: 20
Copertura esclusa

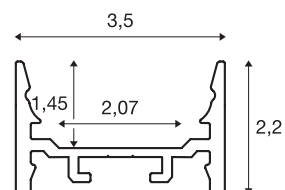

IP 20

Lunghezza (cm)	Colore	Materiale	Articolo	EUR
300	● nero	Alluminio	1000534	75,00
	○ bianco		1000533	75,00

GRAZIA 20

Profilo da incasso

Materiale: alluminio
Larghezza: 5,2 cm; altezza: 3,2 cm
Max. Larghezza LED strip in mm: 20
Copertura esclusa

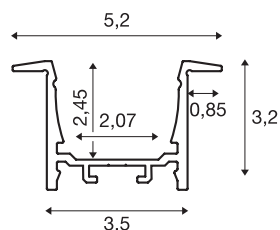

IP 20

Lunghezza (cm)	Colore	Materiale	Articolo	EUR
300	● nero	Alluminio	1000498	105,00
	○ bianco		1000497	105,00

ACCESSORI

GRAZIA 20 Copertura



Descrizione	Colore	Lunghezza (cm)	Larghezza (cm)	Altezza (cm)	Materiale	Articolo	EUR
Copertura	<input type="radio"/> smerigliato	300	3,2	0,6	Policarbonato (PC)	1000540	41,50
	<input type="radio"/> smerigliato				Polimetilmetacrilato (PMMA)	1000546	41,50
	<input type="radio"/> opalescente					1000549	41,50

GRAZIA 20 Raccordo longitudinale



Descrizione	Colore	Lunghezza (cm)	Larghezza (cm)	Altezza (cm)	Materiale	Articolo	EUR
Raccordo	<input checked="" type="radio"/> alluminio	3,8	1,4	0,4	Alluminio	1000571	12,00

Unità di imballaggio: 2 pezzi

GRAZIA 20 Calotte di chiusura per profilo da superficie

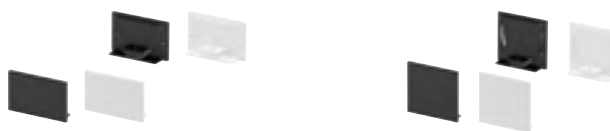

Descrizione	Colore	Lunghezza (cm)	Larghezza (cm)	Altezza (cm)	Materiale	Articolo	EUR
Calotta terminale	<input checked="" type="radio"/> nero, piatto	-	3,5	2,2	Alluminio	1000561	9,25
	<input type="radio"/> bianco, piatto					1000560	9,25
Calotta terminale	<input checked="" type="radio"/> nero, standard	-	3,5	3,2	Alluminio	1000567	9,25
	<input type="radio"/> bianco, standard					1000566	9,25

Unità di imballaggio: 2 pezzi

GRAZIA 20

Calotta di chiusura
per profilo da incasso



Descrizione	Colore	Lunghezza (cm)	Larghezza (cm)	Altezza (cm)	Materiale	Articolo	EUR
Calotta terminale	<input checked="" type="radio"/> nero	-	5,2	3,2	Alluminio	1000558	9,25
	<input type="radio"/> bianco					1000557	9,25

Unità di imballaggio: 2 pezzi

GRAZIA 20

Sospensione



Descrizione	Colore	Lunghezza (cm)	Materiale	Articolo	EUR
Sospensione	<input type="radio"/> cromo	200	Acciaio	1000535	27,25

Unità di imballaggio: 2 pezzi

GRAZIA 20

Clip di fissaggio



Descrizione	Colore	Lunghezza (cm)	Larghezza (cm)	Altezza (cm)	Materiale	Articolo	EUR
Clip di fissaggio	<input type="radio"/> cromo	2	3	0,8	Acciaio	1000536	4,00
Clip di fissaggio	<input checked="" type="radio"/> cromo/alluminio	5,5	7	2,3	Acciaio/alluminio	1004932	22,00

Unità di imballaggio: 2 pezzi



GRAZIA 60

Posa in superficie

Materiale: alluminio
Larghezza: 7 cm, altezza 9,5 cm
Max. Larghezza LED strip in mm: 20
Copertura esclusa



IP 20

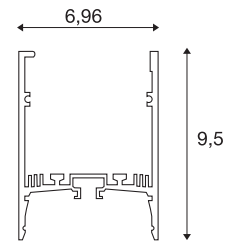

Lunghezza (cm)	Colore	Materiale	Articolo	EUR
150	● nero	Alluminio	1004896	107,00
150	○ bianco		1004897	107,00
300	● nero	Alluminio	1004898	220,00
300	○ bianco		1004899	220,00

GRAZIA 60

Posa a incasso

Materiale: alluminio
Larghezza: 8,6 cm, altezza: 3,3 cm
Max. Larghezza LED strip in mm: 20
Copertura esclusa



IP 20

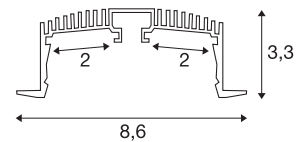
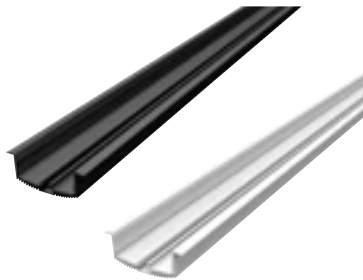

Lunghezza (cm)	Colore	Materiale	Articolo	EUR
150	● nero	Alluminio	1004905	67,00
150	○ bianco		1004906	67,00
300	● nero	Alluminio	1004907	133,00
300	○ bianco		1004908	133,00

ACCESSORI

GRAZIA 60 Copertura



Descrizione	Colore	Lunghezza (cm)	Larghezza (cm)	Altezza (cm)	Materiale	Articolo	EUR
Copertura, 1,5 m	<input checked="" type="radio"/> nero	150	6,5	0,65	Alluminio	1004912	29,00
	<input type="radio"/> bianco					1004913	29,00
	<input type="radio"/> smerigliato				Polimetilmetacrilato (PMMA)	1004914	18,00
	<input type="radio"/> smerigliato					1004916	23,00
Copertura, 3 m	<input type="radio"/> smerigliato	300	6,5		Policarbonato (PC)	1004915	35,00
	<input type="radio"/> smerigliato				Polimetilmetacrilato (PMMA)	1004917	44,00

GRAZIA 60 Calotte terminali

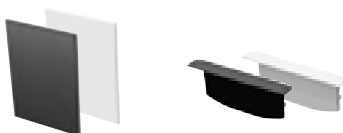

Descrizione	Colore	Lunghezza (cm)	Larghezza (cm)	Altezza (cm)	Materiale	Articolo	EUR
Calotte di chiusura profilo a parete/plafone	<input checked="" type="radio"/> nero	-	7	9,5	Alluminio	1004900	12,50
	<input type="radio"/> bianco	-				1004901	12,50
Calotte di chiusura profilo a incasso	<input checked="" type="radio"/> nero	-	8,6	3,3	Alluminio	1004909	8,50
	<input type="radio"/> bianco	-				1004910	8,50

Unità di imballaggio: 2 pezzi

GRAZIA 60 Staffa di montaggio, profilo da superficie



Descrizione	Colore	Lunghezza (cm)	Larghezza (cm)	Altezza (cm)	Materiale	Articolo	EUR
Profilo di montaggio	<input checked="" type="radio"/> nero	150	6,1	1,2	Alluminio	1004902	35,00

GRAZIA 60

Raccordo lineare,
profilo da superficie



Descrizione	Colore	Lunghezza (cm)	Larghezza (cm)	Altezza (cm)	Materiale	Articolo	EUR
Raccordo longitudinale	● alluminio	8	4,2	1	Alluminio	1004903	12,00

Unità di imballaggio: 2 pezzi

GRAZIA 60

Testata di alimentazione,
profilo da superficie



Descrizione	Colore	Lunghezza (cm)	Larghezza (cm)	Altezza (cm)	Materiale	Articolo	EUR
Testata alimentazione	● alluminio	8	4,2	2,4	Alluminio	1004904	13,00

GRAZIA 60

Clip di fissaggio,
profilo da incasso



Descrizione	Colore	Lunghezza (cm)	Larghezza (cm)	Altezza (cm)	Materiale	Articolo	EUR
Clip di fissaggio	● cromo	13	2,8	4	Alluminio	1004911	15,25

Unità di imballaggio: 2 pezzi

CONTROLLER ZIGBEE 3.0

Per LED strip CCT RGBW 12/24 V



Descrizione	Colore	Lunghezza (cm)	Larghezza (cm)	Altezza (cm)	Materiale	Articolo	EUR
Controller Zigbee	○ bianco	14,5	4,65	1,6	Polycarbonato (PC)	1006348	80,00

CONFIGURA IL TUO PROFILO LED

Crea accenti oppure illumina stanze intere:
sono possibili fino a 21000 lm ogni 5 m

Gioca con il colore: LED Strip disponibili nelle
versioni bianco, CCT (tunable white) o RGBW.

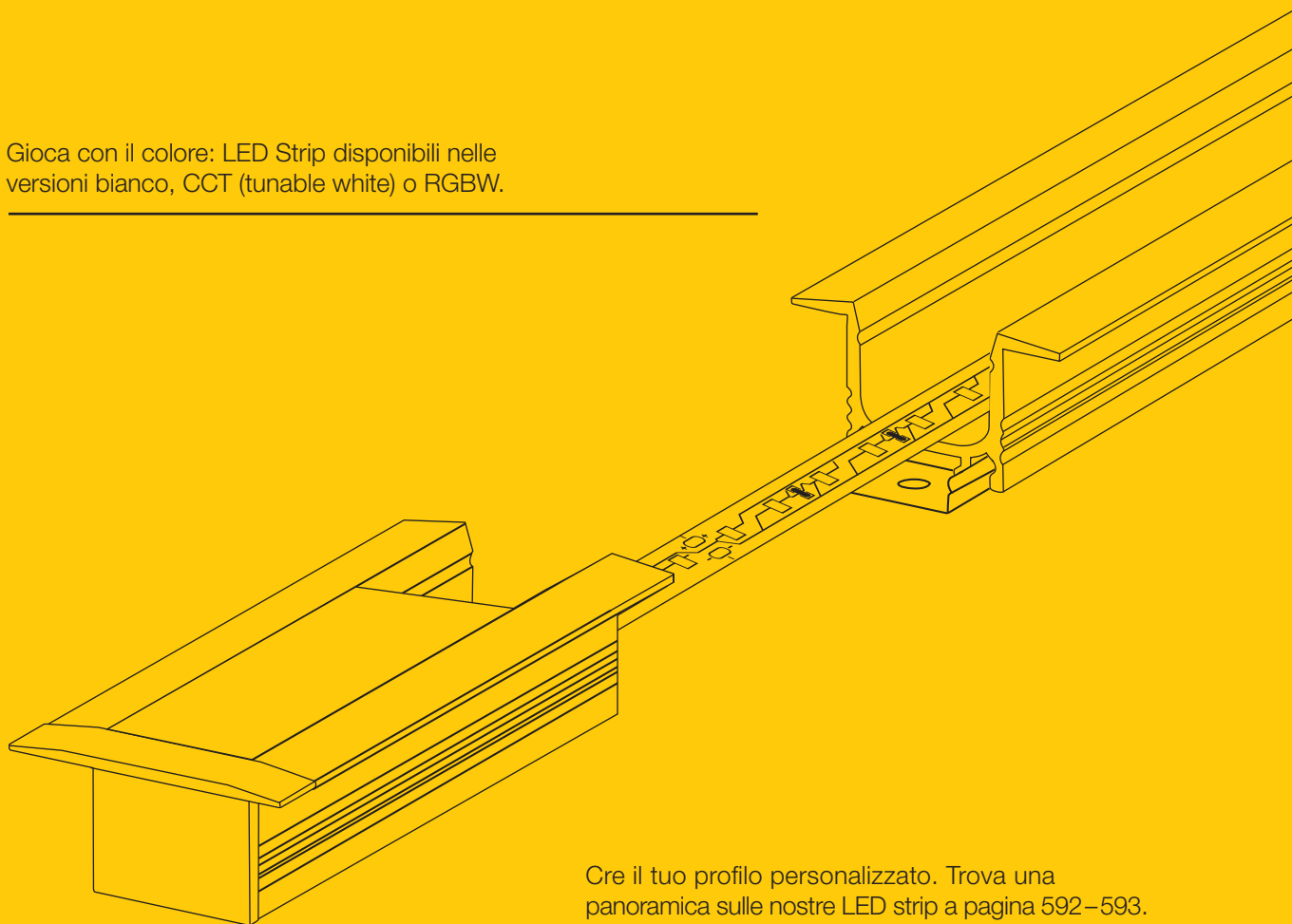

Cre il tuo profilo personalizzato. Trova una
panoramica sulle nostre LED strip a pagina 592–593.
I driver adatti sono disponibili nella sezione dedicata
agli accessori alle pagine 866–881.



Consigliamo di alimentare su entrambi i lati oltre i 3m e di utilizzare un driver ogni 5m

Smerigliata, opalescente o trasparente, nella versione piatta o rialzata: scegli tra diverse coperture per un tocco più personale

Per interni, esterni o ambienti umidi.
Per tutti gli utilizzi, grazie a IP20 e IP54.

Posato in superficie, standard, piatto o angolare, oppure a incasso: abbiamo i profili giusti per tutti i tuoi progetti.

Grazie alla tecnologia a 24V potrai realizzare lunghi tratti con minori punti di accesso



GRAZIA FLEXSTRIP LED 24V

LED/m: 70 | Potenza/m: 8,8 W | Flusso/m: 700-750 lm
 Larghezza: 1 cm
 Altezza: 0,12 cm
 Passo LED: 1,4 cm
 Divisibile ogni: 10 cm
 Codice IP: IP 20
 Cavi di alimentazione su due lati



Temperatura del colore (K)	Flusso luminoso (lm)	Potenza (W)	Indice di resa cromatica (CRI)	Consistenza del colore (SDCM)	Lunghezza (cm)	Articolo	EUR
2700	3500	44	90	3	500	1004708	78,00
3000	3500	44				1004709	
4000	3750	44				1004710	



Versione	Materiale	Lunghezza (cm)	Larghezza (cm)	Altezza (cm)	Articolo	EUR
<input type="radio"/> Driver LED 50W, triac dim	Policarbonato (PC)	18.4	6.1	3.2	1003104	49,50
<input type="radio"/> Driver LED 25W, triac dim		12.8	5.2	3	1006336	35,00
<input type="radio"/> Driver LED 30W, Slim Line, on/off		30	3	1.6	1007250	50,00
<input type="radio"/> Driver LED 30W, Slim Line, DALI					1007254	60,00
<input type="radio"/> Driver LED 100W, Slim Line, on/off		35	1.8	1007251	80,00	
<input type="radio"/> Driver LED 100W, Slim Line, DALI				1007255	110,00	



GRAZIA PRO FLEXSTRIP 24V

LED/m: 126 | Potenza/m: 14,6 W | Flusso/m: 1300-1400 lm
 Larghezza: 1 cm
 Altezza: 0,12 cm
 Passo LED: 0,8 cm
 Divisibile ogni: 5,6 cm
 Codice IP: IP 20
 Cavi di alimentazione su due lati



Temperatura del colore (K)	Flusso luminoso (lm)	Potenza (W)	Indice di resa cromatica (CRI)	Consistenza del colore (SDCM)	Lunghezza (cm)	Articolo	EUR
2700	6500	73				1004712	
3000	6500	73	90	3	500	1004713	125,00
4000	7000	73				1004714	



Versione	Materiale	Lunghezza (cm)	Larghezza (cm)	Altezza (cm)	Articolo	EUR
<input type="radio"/> Driver LED 50W, triac dim	Policarbonato (PC)	18.4	6.1	3.2	1003104	49,50
<input type="radio"/> Driver LED 25W, triac dim		12.8	5.2	3	1006336	35,00
<input type="radio"/> Driver LED 30W, Slim Line, on/off		30	3	1.6	1007250	50,00
<input type="radio"/> Driver LED 30W, Slim Line, DALI				1.6	1007254	60,00
<input type="radio"/> Driver LED 100W, Slim Line, on/off		35		1.8	1007251	80,00
<input type="radio"/> Driver LED 100W, Slim Line, DALI				1.8	1007255	110,00

Per garantire la dissipazione del calore, le strisce LED devono essere incollate su un profilo in alluminio. Retro delle LED Strip provvisto di nastro adesivo.
 Per ottenere un'emissione luminosa omogenea a partire da una lunghezza di 3 m, si consiglia di alimentare le strisce su entrambi i lati.
 Per una lunghezza superiore a 5 m, è necessario inserire un nuovo alimentatore.



GRAZIA PRO FLEXSTRIP 24V

LED/m: 168 | Potenza/m: 18,2 W | Flusso/m: 1700-1820 lm
 Larghezza: 1 cm
 Altezza: 0,12 cm
 Passo LED: 0,6 cm
 Divisibile ogni: 4,2 cm
 Codice IP: IP 20
 Cavi di alimentazione su due lati



Temperatura del colore (K)	Flusso luminoso (lm)	Potenza (W)	Indice di resa cromatica (CRI)	Consistenza del colore (SDCM)	Lunghezza (cm)	Articolo	EUR
2700	8500	91	90	3	500	1004716	145,00
3000	8500	91				1004717	
4000	9100	91				1004718	
6500	9100	91				1004719	



Versione	Materiale	Lunghezza (cm)	Larghezza (cm)	Altezza (cm)	Articolo	EUR
<input type="radio"/> Driver LED 50W, triac dim	Policarbonato (PC)	18.4	6.1	3.2	1003104	49,50
<input type="radio"/> Driver LED 25W, triac dim		12.8	5.2	3	1006336	35,00
<input type="radio"/> Driver LED 30W, Slim Line, on/off		30	3	1.6	1007250	50,00
<input type="radio"/> Driver LED 30W, Slim Line, DALI					1007254	60,00
<input type="radio"/> Driver LED 100W, Slim Line, on/off		35	1.8	1007251	80,00	
<input type="radio"/> Driver LED 100W, Slim Line, DALI				1007255	110,00	



GRAZIA PRO MAX FLEXSTRIP 24V

LED/m: 196 | Potenza/m: 25,2 W | Flusso/m: 2500-2600 lm
 Larghezza: 2 cm
 Altezza: 0,15 cm
 Passo LED: 0,5 cm
 Divisibile ogni: 3,6 cm
 Codice IP: IP 20
 Cavi di alimentazione su due lati



Temperatura del colore (K)	Flusso luminoso (lm)	Potenza (W)	Indice di resa cromatica (CRI)	Consistenza del colore (SDCM)	Lunghezza (cm)	Articolo	EUR
3000	12500	126	90	3	500	1004720	199,00
4000	13000	126				1004721	



Versione	Materiale	Lunghezza (cm)	Larghezza (cm)	Altezza (cm)	Articolo	EUR
<input type="radio"/> Driver LED 150W, Slim Line, on/off	Policarbonato (PC)	35	3	1.8	1007252	100,00
<input type="radio"/> Driver LED 150W, Slim Line, DALI					1007256	140,00

Per garantire la dissipazione del calore, le strisce LED devono essere incollate su un profilo in alluminio. Retro delle LED Strip provvisto di nastro adesivo.
 Per avere la stessa potenza a partire da una lunghezza di 3 m, si consiglia di alimentare le strisce su entrambi i lati.
 Per una lunghezza superiore a 5 m, è necessario inserire un nuovo alimentatore.



GRAZIA PRO MAX FLEXSTRIP 24V

LED/m: 196 | Potenza/m: 38,6 W | Flusso/m: 4000-4280 lm
 Larghezza: 2 cm
 Altezza: 0,15 cm
 Passo LED: 1 cm
 Divisibile ogni: 7,1 cm
 Codice IP: IP 20
 Cavi di alimentazione su due lati



Temperatura del colore (K)	Flusso luminoso (lm)	Potenza (W)	Indice di resa cromatica (CRI)	Consistenza del colore (SDCM)	Lunghezza (cm)	Articolo	EUR
3000	20000	193	90	3	500	1004722	350,00
4000	21400					1004723	



Versione	Materiale	Lunghezza (cm)	Larghezza (cm)	Altezza (cm)	Articolo	EUR
<input type="radio"/> Driver LED 250W, Slim Line, on/off	Policarbonato (PC)	40	4	2.2	1007253	120,00
<input type="radio"/> Driver LED 250W, Slim Line, DALI					1007257	160,00



GRAZIA PRO FLEXSTRIP tunable white, 24V

LED/m: 224 | Potenza/m: 8 W | Flusso/m: 700-750 lm
 Larghezza: 1 cm
 Altezza: 0,12 cm
 Passo LED: 0,9 cm
 Divisibile ogni: 6,3 cm
 Codice IP: IP 20
 Cavi di alimentazione su due lati



Temperatura del colore (K)	Flusso luminoso (lm)	Potenza (W)	Indice di resa cromatica (CRI)	Consistenza del colore (SDCM)	Lunghezza (cm)	Articolo	EUR
2700-6500	3400-3700	40	90	6	500	1004725	153,00



Versione	Materiale	Lunghezza (cm)	Larghezza (cm)	Altezza (cm)	Articolo	EUR
<input type="radio"/> DALI Controller 1 Canale, push-dim	Policarbonato (PC)	11.6	4.2	1.8	1003106	64,00
<input type="radio"/> Driver LED 60W, DALI, 2 Canale		20.2	5.8	3	1006133	153,00
<input type="radio"/> SMART Controller 1-5 canali, selezionabili tramite DIP		14.5	4.65	1.6	1006348	80,00
<input type="radio"/> Driver LED 100W, Slim Line, on/off		35	3	1.8	1007251	80,00
<input type="radio"/> Driver LED 100W, Slim Line, DALI					1007255	110,00

Per garantire la dissipazione del calore, le strisce LED devono essere incollate su un profilo in alluminio. Retro delle LED Strip provvisto di nastro adesivo.
 Per avere la stessa potenza a partire da una lunghezza di 3 m, si consiglia di alimentare le strisce su entrambi i lati.
 Per una lunghezza superiore a 5 m, è necessario inserire un nuovo alimentatore.



GRAZIA PRO FLEXSTRIP RGBW, 24V

LED/m: 70
 Potenza/m: 12W (RGB); 5,4W (W) | Flusso/m: 500lm (RGB); 410lm (W)
 Larghezza: 1,2 cm
 Altezza: 0,22 cm
 Passo LED: 1,4 cm
 Divisibile ogni: 10 cm
 Codice IP: IP 20
 Cavi di alimentazione su entrambi i lati



Temperatura del colore (K)	Flusso luminoso (lm)	Potenza (W)	Indice di resa cromatica (CRI)	Consistenza del colore (SDCM)	Lunghezza (cm)	Articolo	EUR
RGB	2500	60	90	6	500	1004727	155,00
W 3000	2050	27					



Versione	Materiale	Lunghezza (cm)	Larghezza (cm)	Altezza (cm)	Articolo	EUR
<input type="radio"/> SMART Controller 1-5 canali, selezionabili tramite DIP	Policarbonato (PC)	14.5	4.65	1.6	1006348	80,00
<input type="radio"/> Driver LED 100W, Slim Line, on/off		35	3	1.8	1007251	80,00

Per garantire la dissipazione del calore, le strisce LED devono essere incollate su un profilo in alluminio. Retro delle LED Strip provvisto di nastro adesivo.
 Per avere la stessa potenza a partire da una lunghezza di 3 m, si consiglia di alimentare le strisce su entrambi i lati.
 Per una lunghezza superiore a 5 m, è necessario inserire un nuovo alimentatore.

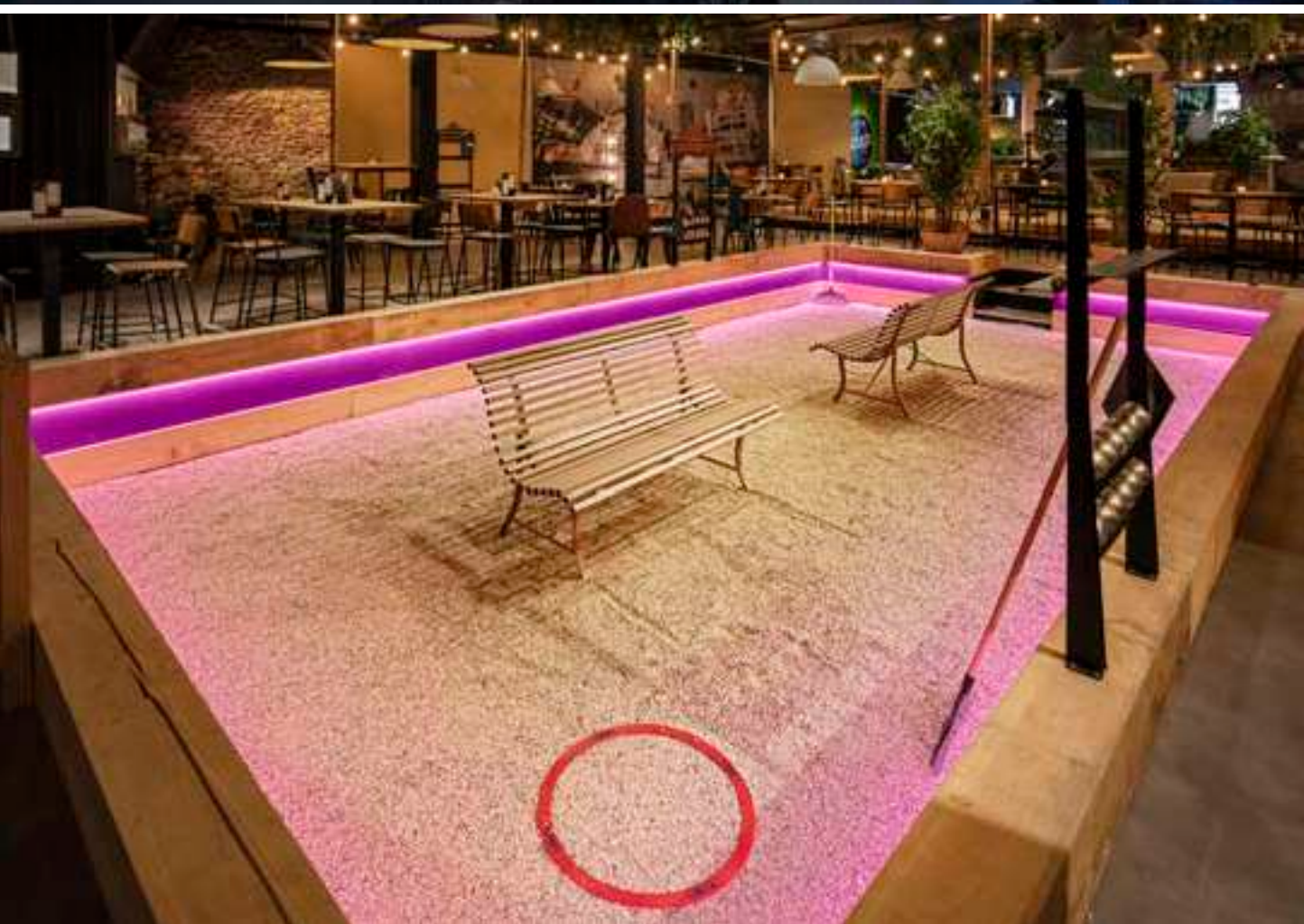

GRAZIA IP FLEXSTRIP 24V

LED/m: 70 | Potenza/m: 8,8 W | Flusso/m: 670-720 lm
Larghezza: 1,2 cm
Altezza: 0,4 cm
Passo LED: 1,4 cm
Divisibile ogni: 10 cm
Codice IP: IP 54
Cavi di alimentazione su due lati



Temperatura del colore (K)	Flusso luminoso (lm)	Potenza (W)	Indice di resa cromatica (CRI)	Consistenza del colore (SDCM)	Lunghezza (cm)	Articolo	EUR
2700	3350					1004734	
3000	3350	44	90	4	502	1004735	99,00
4000	3600					1004736	

GRAZIA IP FLEXSTRIP tunable white, 24V

LED/m: 224 | Potenza/m: 8 W | Flusso/m: 642-700 lm
Larghezza: 1,2 cm
Altezza: 0,4 cm
Passo LED: 0,9 cm
Divisibile ogni: 6,3 cm
Codice IP: IP 54
Cavi di alimentazione su due lati



Temperatura del colore (K)	Flusso luminoso (lm)	Potenza (W)	Indice di resa cromatica (CRI)	Consistenza del colore (SDCM)	Lunghezza (cm)	Articolo	EUR
2700-6500	3210-3500	40	90	4	502	1004726	170,00

Con 2 calotte di chiusura e materiale di montaggio inclusi

GRAZIA IP FLEXSTRIP RGBW, 24V

LED/m: 70
Potenza/m: 12W (RGB); 5,4W (W) | Flusso/m: 470lm (RGB); 390lm (W)
Larghezza: 1,4 cm
Altezza: 0,46 cm
Passo LED: 1,4 cm
Divisibile ogni: 10 cm
Codice IP: IP 54
Cavi di alimentazione su due lati



Temperatura del colore (K)	Flusso luminoso (lm)	Potenza (W)	Indice di resa cromatica (CRI)	Consistenza del colore (SDCM)	Lunghezza (cm)	Articolo	EUR
RGB	2350	60	90	6	502	1004737	210,00
W 3000	1958	27					

Per garantire la dissipazione del calore, le strisce LED devono essere incollate su un profilo in alluminio. Retro delle LED Strip provvisto di nastro adesivo.
Per avere la stessa potenza a partire da una lunghezza di 3 m, si consiglia di alimentare le strisce su entrambi i lati.
Per una lunghezza superiore a 5 m, è necessario inserire un nuovo alimentatore.

FLEXSTRIPS PANORAMICA

GRAZIA LED

1004708
1004709
1004710

70 LED/m

GRAZIA PRO

1004712
1004713
1004714

126 LED/m

GRAZIA PRO

1004716
1004717
1004718
1004719

168 LED/m

GRAZIA PRO MAX

1004720
1004721

196 LED/m

GRAZIA PRO MAX

1004722
1004723

196 LED/m

500
cm

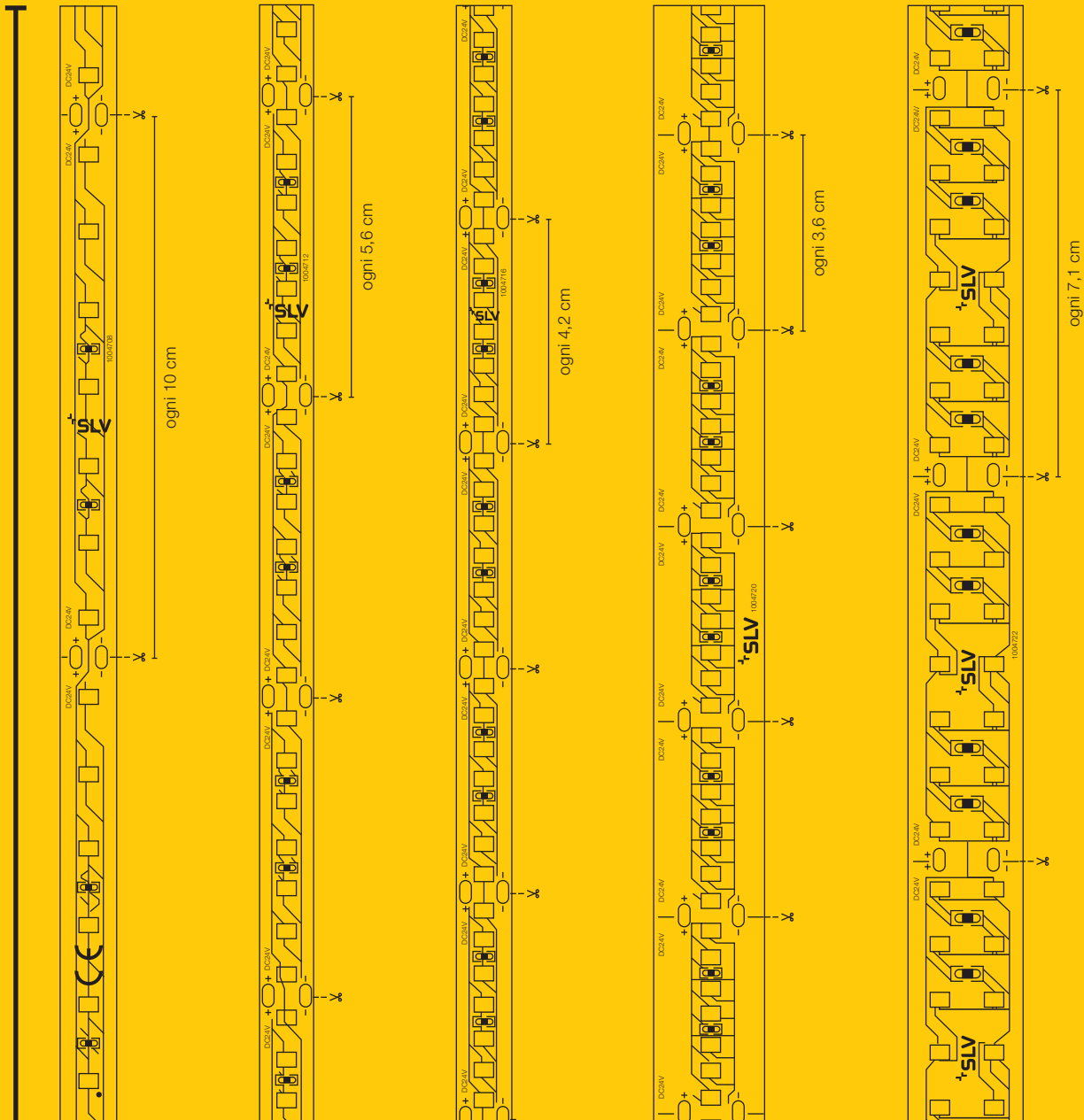



Tutte le strisce a LED GRAZIA funzionano a 24V. Driver e altri accessori sono disponibili a pagina 582.



**GRAZIA
PRO MAX**
TUNABLE WHITE
1004725

224 LED/m

**GRAZIA
PRO MAX**
RGBW
1004727

70 LED/m

GRAZIA IP
1004734
1004735
1004736

70 LED/m

**GRAZIA
IP**
TUNABLE WHITE
1004726

224 LED/m

**GRAZIA
IP**
RGBW
1004737

70 LED/m

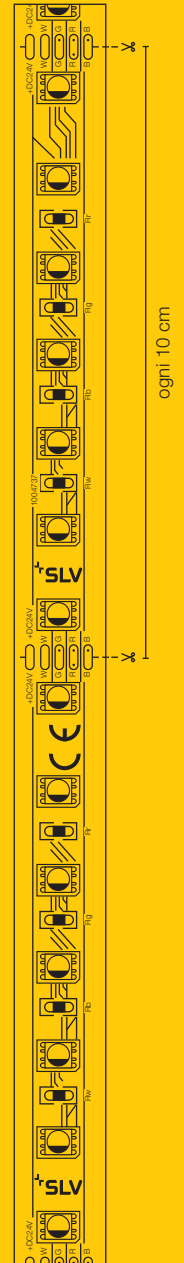
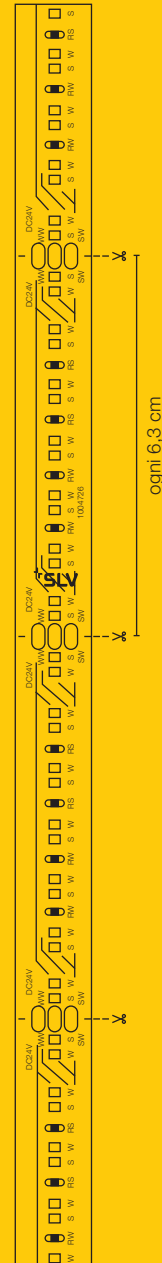
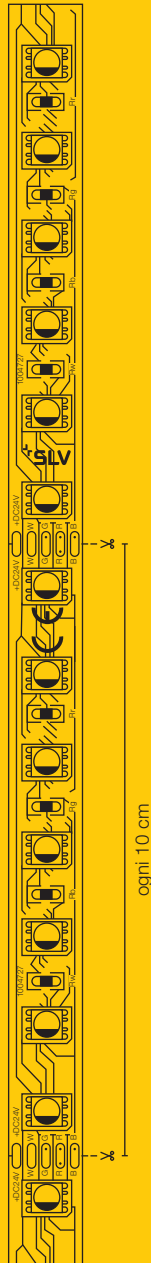
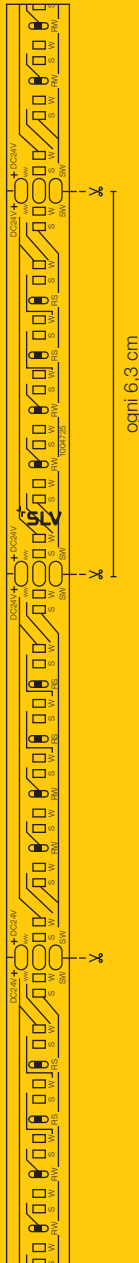



NEW

LED
VINOLINA ONE | 597



NEW

LED
VINOLINA | 597



NEW

LED
VINOLINA TWO | 599



LED
TONILA | 601



NEW

LED
TAHA | 601



NEW

SCKET
S-TUBE 32/75 | 603



NEW

SCKET
PHOTONI 45/75 | 605



NEW

LED
S-CUBE 35/75 | 607



NEW

LED
R-CUBE 35/70 | 609



NEW

LED
LID I 75 | 611

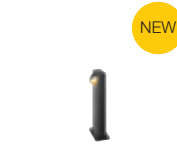

NEW

LED
LID I 45 | 611



NEW

LED
I-RING | 613



NEW

LED
M-POL S | 614



NEW

LED
M-POL S | 615



LED
M-POL S | 616



LED
M-POL S | 617



LED
M-POL S | 618



LED
M-POL M | 619



LED
M-POL M | 620



LED
M-POL M | 621



M-POL 30/60/90 | 623



SCKET
CONCRETO | 627



SCKET
CONCRETO | 627



LED
ESKINA
FRAME 45/75 | 629



LED
ESKINA
FRAME 75 | 629



LED
ESKINA FRAME
125/175 | 630



LED
ESKINA 30/80 | 631



LED
LOGS 40/70 | 633



SCKET
GRAFIT 30/60/90 | 635



SCKET
GRAFIT 30/60/90 | 637



LED
QUADRULO | 639



LED
RUSTY®
SLOT 50/80 | 640



SCKET
RUSTY®
SLOT 50/80 | 641



SCKET
RUSTY®
PATHLIGHT | 642



LED
RUSTY® 40/70 | 643



SCKET
RUSTY® 40/70 | 643



SCKET
RUSTY®
CONE 24 | 645



SCKET
RUSTY®
CONE 40/70 | 645



SCKET
RUSTY® 40/70 | 646



SCKET
ARROCK
GRANITE 40/70 | 647



SCKET
ARROCK
ARC | 648



LED
ARROCK
STONE 50/75 | 649



SCKET
ARROCK SLOT | 649



LED
L-LINE OUT 30 | 650



LED
L-LINE OUT 60 | 651



LED
L-LINE OUT 50/80 | 651



SCKET
THEO PATHLIGHT | 652



LED
OVALISK 75/100 | 653



SCKET
GLOO PURE 27/44/70 | 655



SCKET
ROTOBALL 25/40/50 | 657



SCKET
PHOTONIA | 659



SCKET
PHOTONIA | 659



SCKET
OTOS GLAS | 659



SCKET
CUBIX | 660



SCKET
CONE | 660



SCKET
MOLAT | 661



SCKET
MOLAT | 661



SCKET
LISENNE 40/70 | 662



SCKET
ADEGAN MANILA | 663



SCKET
ADEGAN | 663



SCKET
ALPA MUSHROOM 45/75 | 665



SCKET
ALPA CONE 100 | 665



LED
APONI 90/120 | 666



LED
TRUST 30/60 | 667



SCKET
BIG NAILS 50/80 | 668



SCKET
ROX ACRYL 30/60/90 | 669



SCKET
VAP SLIM 30/60/90 | 671



SCKET
C-POL | 672



SCKET
F-POL | 672



SCKET
SQUARE POLE 30/60/90 | 673



LED
SLOTS 45/65 | 675



LED
H-POL 30/60 | 676



LED
H-POL TWIN 30/60 | 677



LED
SLOTBOX 40/70 | 678



LED
FLATT 65/100 | 679



LED
ABRIDOR 60/100 | 681



LED
IPERI 50 | 681



SCKET
QUADRASYL 75 | 682



LED
QUAD POLE | 683



LED
BOOKAT | 683



LED
RASCALI 45/65 | 684



SCKET
MYRA SPOT | 685



SCKET
SITRA 360 | 685



1007357 597



1007360 597



VINOLINA ONE TL, Batteria ricaricabile

VINOLINA TL, Batteria ricaricabile

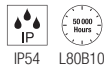
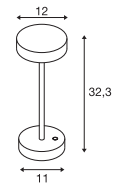
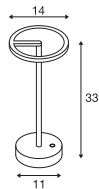
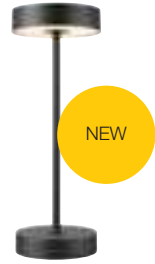

Funzionamento a batteria a 5V
Potenza assorbita: 2,5W
Materiale: alluminio

- Durata 12h
- Tempo di carica 7h
- Base di carica inclusa
- Alimentatore escluso
- USB A

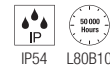

Funzionamento a batteria a 5V
Potenza assorbita: 2,2W
Materiale: alluminio

- Durata 12h
- Tempo di carica 7h
- Base di carica inclusa
- Alimentatore escluso
- USB A



Down 125lm | 2700K



Down 130lm | 2700K | 130lm | 3000K

Versione	Articolo	EUR
● nero	1007359	139,00
○ bianco	1007357	139,00
● ruggine	1007358	139,00

Versione	Articolo	EUR
● nero	1007362	139,00
○ bianco	1007360	139,00
● ruggine	1007361	139,00



1007697 599



VINOLINA TWO

TL, Batteria ricaricabile

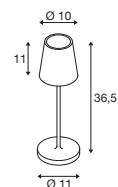

IP65 L70B20

Funzionamento a batteria a 5V

Potenza assorbita: 2W

Materiale: alluminio

- Dimmerabile TOUCH
- Durata 10h
- Tempo di carica 5h
- Compresa base di ricarica singola



Down

190lm

2200K
2700K
3000K

Versione	Articolo	EUR
● nero	1007693	139,00
○ bianco	1007692	139,00
● sabbia	1007697	139,00
● ruggine	1007695	139,00
● rosso	1007694	139,00
● verde salvia	1007696	139,00



1007380 601



1007380 601



TONILA TL

TAHA Set lampada, batteria

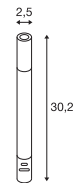
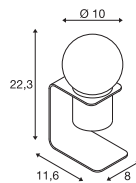

Funzionamento a batteria a 5V
Potenza assorbita: 1,6W
Materiale: alluminio/plastica

- Batteria 3,6V 2000 mAh inclusa
- Necessari caricabatterie USB 5V DC 2A e cavo di ricarica micro-USB (non inclusi)
- Dimmerabile su 3 livelli tramite pulsante



Down 90lm | 2700K

Versione	Articolo	EUR
● nero	1002583	118,00

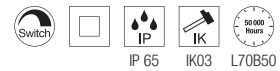

100-240V ~50/60Hz |
Funzionamento a batteria da 5V
Potenza assorbita: 5W
Max. voltaggio driver: 5V DC
Materiale: alluminio/plastica

- Cavo di ricarica incluso



Down 200lm | 2700K

Versione	Articolo	EUR
● nero	1007380	159,00

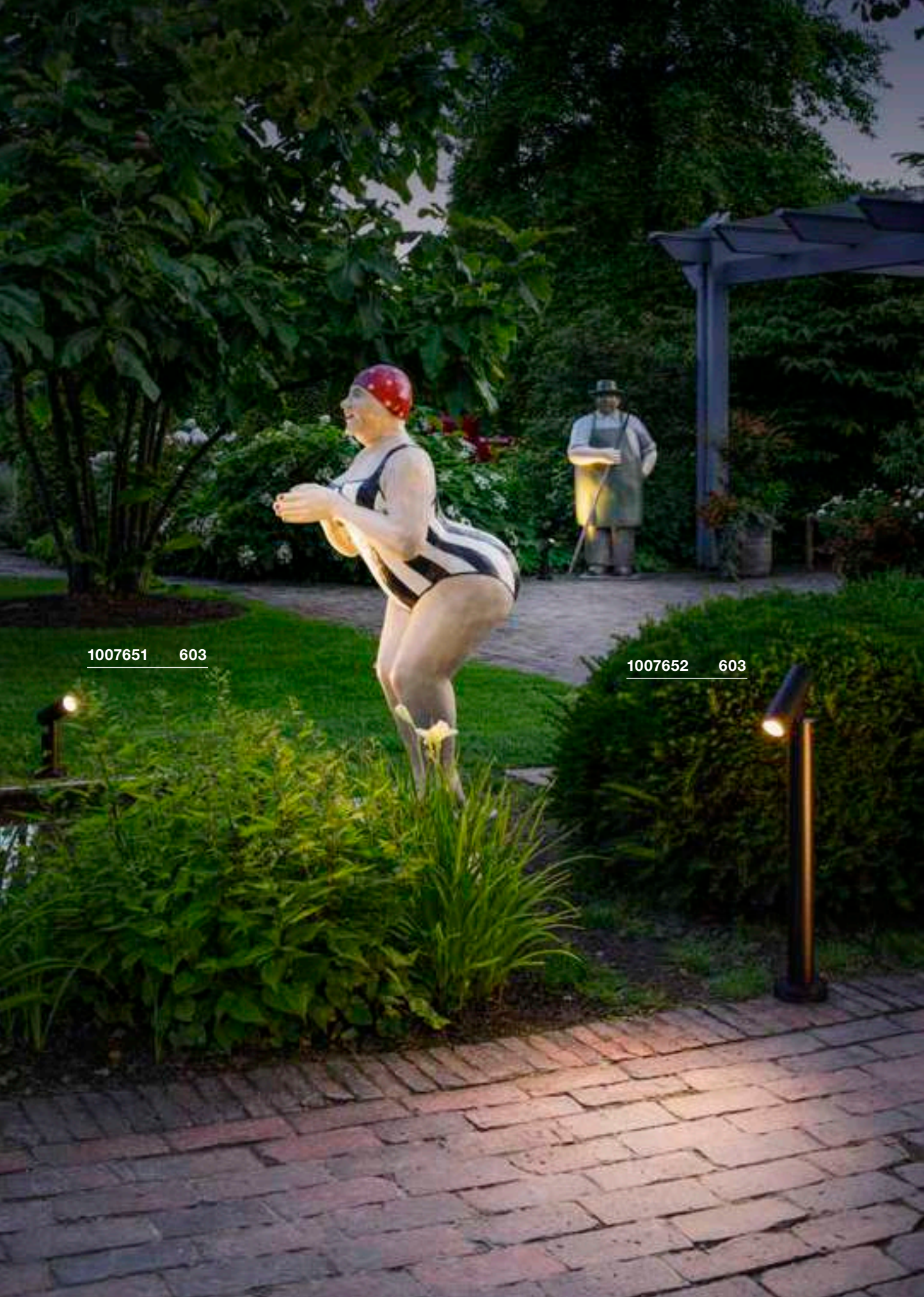

1007651 603

1007652 603



S-TUBE 32 Pole, GU10

S-TUBE 75 Pole, GU10

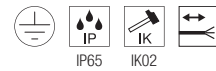
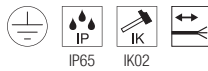
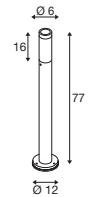
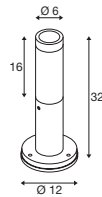

220-240V ~50/60Hz
Materiale: alluminio

220-240V ~50/60Hz
Materiale: alluminio

- Cavo con terminale aperto

- Cavo con terminale aperto

SOCKET <10
W

SOCKET <10
W

Attacco: 1xGU10 Ø max.: 5 cm L: 5,5 cm

Attacco: 1xGU10 Ø max.: 5 cm L: 5,5 cm

Versione	Articolo	EUR
● nero	1007651	● 84,00

Versione	Articolo	EUR
● nero	1007652	● 134,00

LED GU10 51mm | 6W | 38°
2700K | 450lm | Classe=F
6kWh/1000h

Articolo: 1005077 | 7,50 EUR

LED GU10 51mm | 6W | 38°
2700K | 450lm | Classe=F
6kWh/1000h

Articolo: 1005077 | 7,50 EUR

Articolo	Articolo	EUR
Connettore IP68, 3 poli		
● nero	228730	23,00

Articolo	Articolo	EUR
Connettore IP68, 3 poli		
● nero	228730	23,00



1007587 605

1007584 605



PHOTONI 45

Pole, E27

PHOTONI 75

Pole, E27

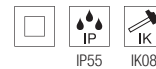
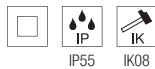
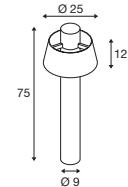
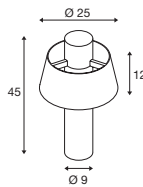

220-240V ~50/60Hz
Materiale: alluminio

220-240V ~50/60Hz
Materiale: alluminio

- Connettore IP68 incluso
- Resistente all'aria marina

- Connettore IP68 incluso
- Resistente all'aria marina



Attacco: 1xE27 Ø max.: 6 cm L: 11,6 cm

Attacco: 1xE27 Ø max.: 6 cm L: 11,6 cm

Versione	Articolo	EUR
● nero	1007587	179,00
● ruggine	1007583	179,00

Versione	Articolo	EUR
● nero	1007584	199,00
● ruggine	1007580	199,00



A60 | 7,5W | 180°
2700K | 720lm | Classe=F
8kWh/1000h



Articolo: 1005305 | 19,00 EUR



A60 | 7,5W | 180°
2700K | 720lm | Classe=F
8kWh/1000h



Articolo: 1005305 | 19,00 EUR



1007459 607

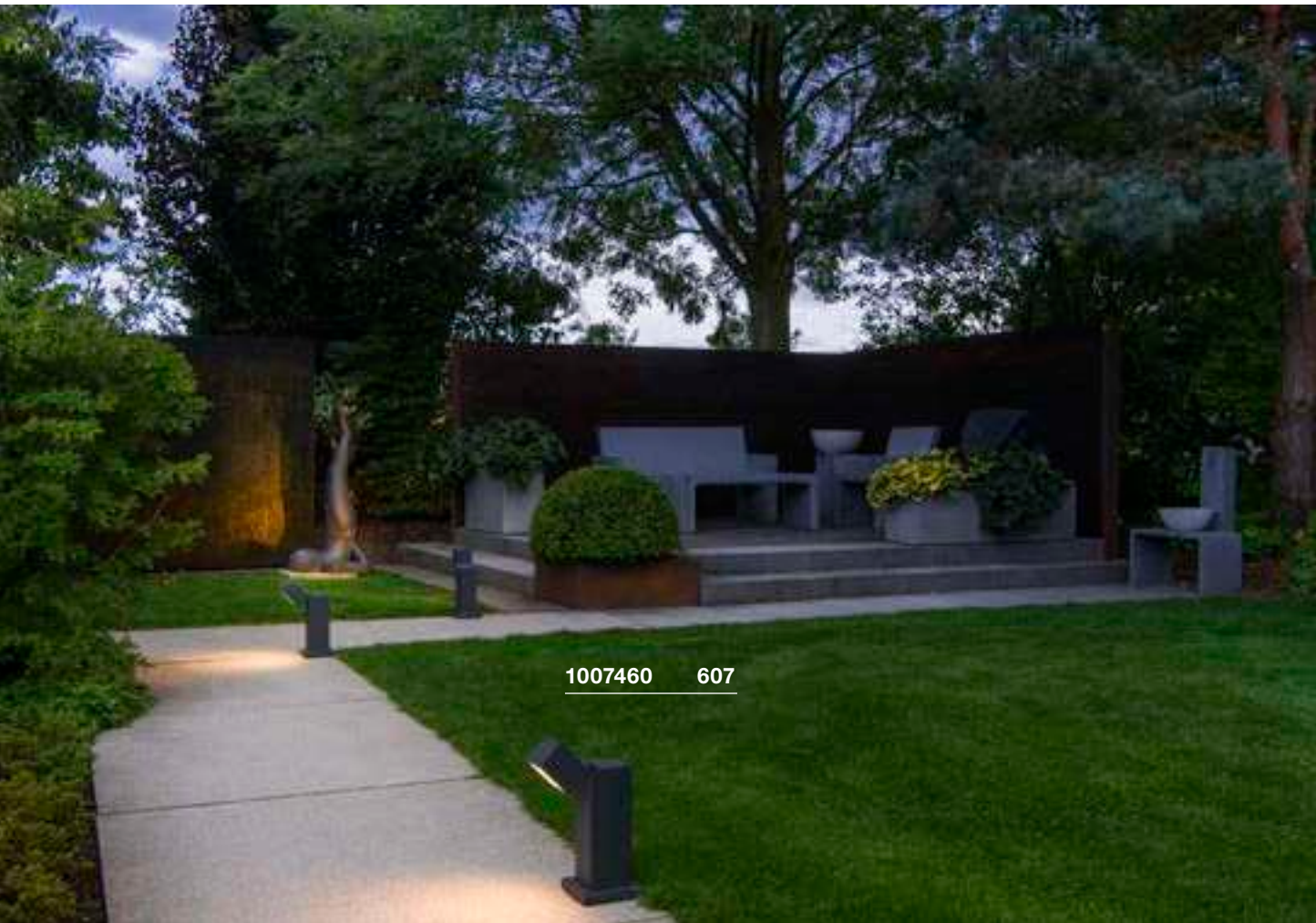

1007460 607



S-CUBE 35 Pole

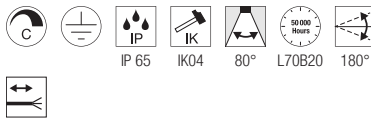
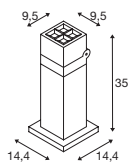

220-240V ~50/60Hz | 350mA
Potenza assorbita: 15W
Materiale: alluminio

- Cavo con terminale aperto



Down 1000lm | 2700K | 1200lm | 3000K

Versione	Articolo	EUR
● antracite	1007460	● 199,00



Articolo	Articolo	EUR
● nero	228730	23,00

Connettore IP68, 3 poli

S-CUBE 75 Pole

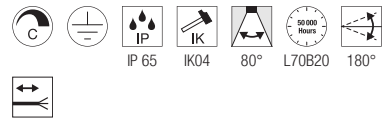
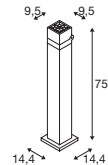

220-240V ~50/60Hz | 350mA
Potenza assorbita: 15W
Materiale: alluminio

- Cavo con terminale aperto



Down 1000lm | 2700K | 1200lm | 3000K

Versione	Articolo	EUR
● antracite	1007459	● 234,00



Articolo	Articolo	EUR
● nero	228730	23,00

Connettore IP68, 3 poli



1007513 609



R-CUBE 35 Pole

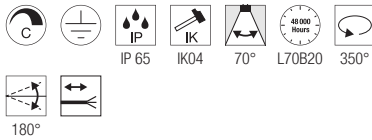
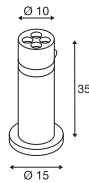
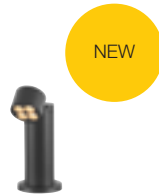

220-240V ~50/60Hz | 350mA
Potenza assorbita: 15W
Materiale: alluminio

- Cavo con terminale aperto



Down 800lm | 2700K | 800lm | 3000K

Versione	Articolo	EUR
● antracite	1007513	● 199,00



Articolo	Articolo	EUR
Connettore IP68, 3 poli		
● nero	228730	23,00

R-CUBE 75 Pole

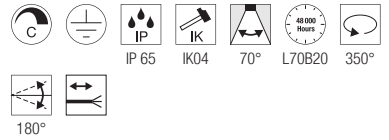
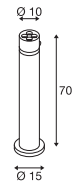

220-240V ~50/60Hz | 350mA
Potenza assorbita: 15W
Materiale: alluminio

- Cavo con terminale aperto



Down 800lm | 2700K | 800lm | 3000K

Versione	Articolo	EUR
● antracite	1007512	● 234,00



Articolo	Articolo	EUR
Connettore IP68, 3 poli		
● nero	228730	23,00



1007670 611

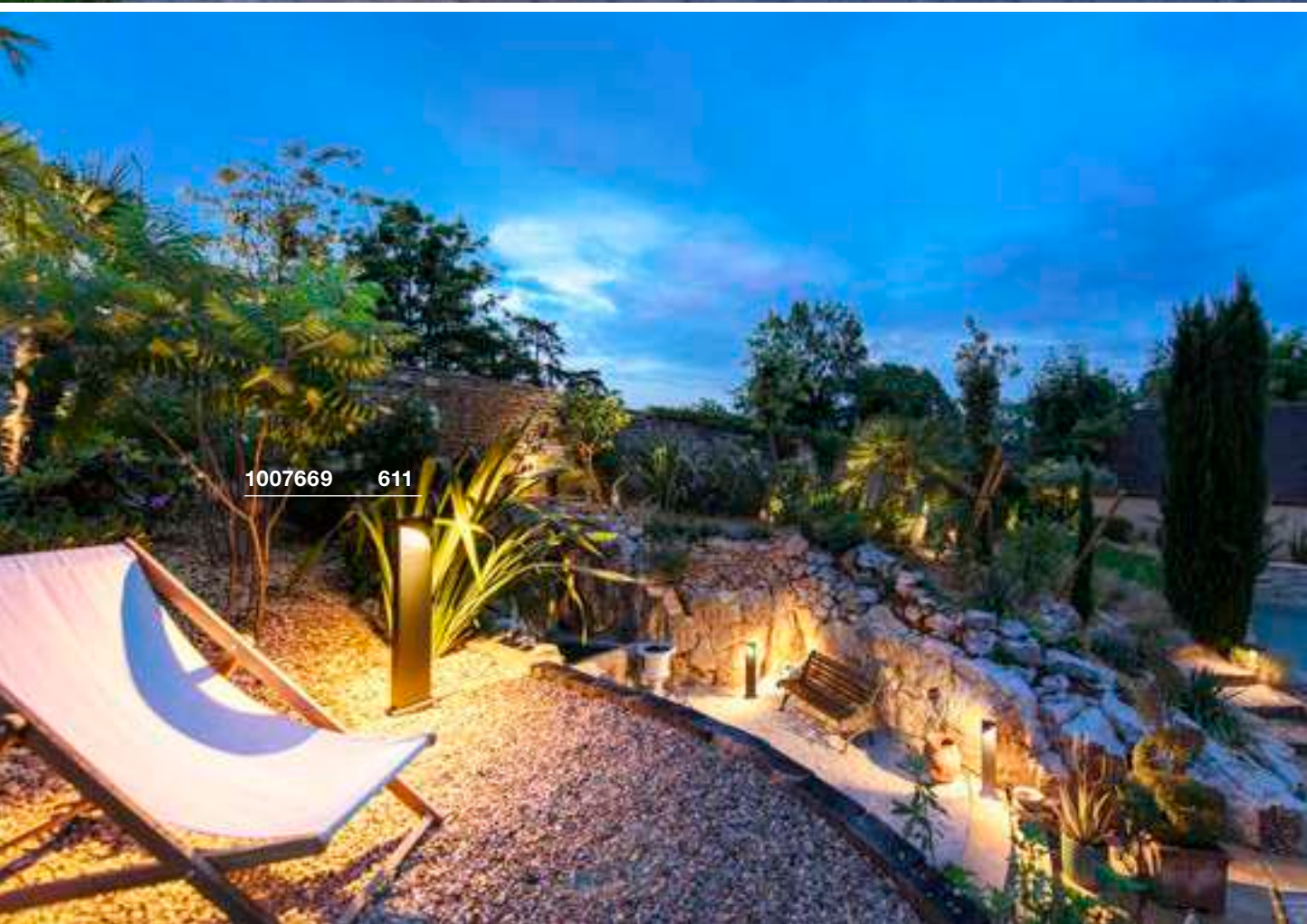

1007669 611



LID I 75 Pole, double

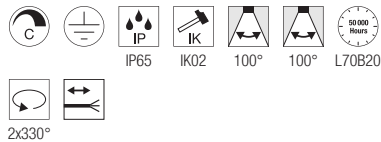
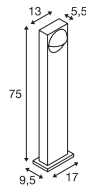

220-240V ~50/60Hz | 700mA
Potenza assorbita: 29W
Materiale: alluminio

- Cavo con terminale aperto



Down 850lm | 2700K | 1000lm | 3000K

Versione	Articolo	EUR
● antracite	1007669	● 299,00



Articolo	Articolo	EUR
Connettore IP68, 3 poli		
● nero	228730	23,00

LID I 45 Pole, single

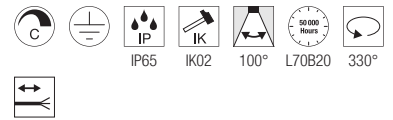
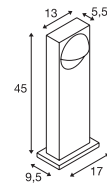

220-240V ~50/60Hz | 350mA
Potenza assorbita: 15W
Materiale: alluminio

- Cavo con terminale aperto



Down 900lm | 2700K | 1050lm | 3000K

Versione	Articolo	EUR
● antracite	1007670	● 219,00



Articolo	Articolo	EUR
Connettore IP68, 3 poli		
● nero	228730	23,00



1007237 613



I-RING Pole

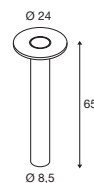

100-240V ~50/60Hz | 350mA
 Potenza assorbita: 9,2W
 Materiale: alluminio



Down

670lm | 3000K

Versione	Articolo	EUR
● antracite	1007237	● 229,00



Articolo	Articolo	EUR
Set di viti		
● acciaio inox	228753	9,25

M-POL S
Polehead 360°, con controllo
dell'abbigliamento

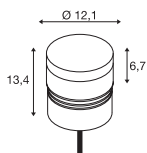

220-240V ~50/60Hz | 500mA
Potenza assorbita: 10W
Materiale: alluminio



Down 750lm | 2700K

Versione	Articolo	EUR
● antracite	1007232	● 290,00



Articolo	Articolo	EUR
Palo		
● antracite		
H: 23,4 cm	1006379	99,00
● antracite		
H: 53,4 cm	1006380	139,00
● antracite		
H: 83,4 cm	1006381	169,00
Ancoraggio a terra		
● acciaio inox	1006382	49,00
Connettore IP68 a T, 3 poli		
● nero	228726	36,00
Connettore IP68, 3 poli		
● nero	228730	23,00

M-POL S
Polehead 360°, con controllo
dell'abbigliamento, DALI

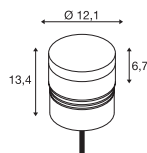

220-240V ~50/60Hz | 500mA
Potenza assorbita: 10W
Materiale: alluminio



Down 750lm | 2700K

Versione	Articolo	EUR
● antracite	1007233	● 310,00



Articolo	Articolo	EUR
Pole		
● antracite		
H: 23,4 cm	1006379	99,00
● antracite		
H: 53,4 cm	1006380	139,00
● antracite		
H: 83,4 cm	1006381	169,00
Ancoraggio a terra		
● acciaio inox	1006382	49,00
Connettore IP68, 5 poli		
● nero	228725	17,90
Connettore IP68 a Y, 5 poli		
● nero	1006453	● 35,00



1006381 + 1007233 623 + 614



1006380 + 1007232 623 + 614



1006380 + 1007235 623 + 615



M-POL S

Polehead 180°, con controllo dell'abbagliamento

M-POL S

Polehead 180°, con controllo dell'abbagliamento, DALI

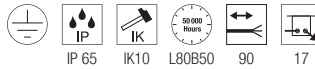
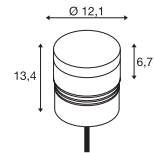
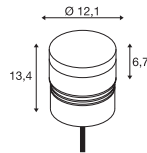

220-240V ~50/60Hz | 500mA
Potenza assorbita: 10W
Materiale: alluminio



220-240V ~50/60Hz | 500mA
Potenza assorbita: 10W
Materiale: alluminio



Down 700lm | 2700K



Down 700lm | 2700K

Versione	Articolo	EUR
● antracite	1007234	● 299,00

Versione	Articolo	EUR
● antracite	1007235	● 319,00



Articolo	Articolo	EUR
Palo		
● antracite		
H: 23,4 cm	1006379	99,00
● antracite		
H: 53,4 cm	1006380	139,00
● antracite		
H: 83,4 cm	1006381	169,00
Ancoraggio a terra		
● acciaio inox	1006382	49,00
Connettore IP68 a T, 3 poli		
● nero	228726	36,00
Connettore IP68, 3 poli		
● nero	228730	23,00



Articolo	Articolo	EUR
Pole		
● antracite		
H: 23,4 cm	1006379	99,00
● antracite		
H: 53,4 cm	1006380	139,00
● antracite		
H: 83,4 cm	1006381	169,00
Ancoraggio a terra		
● acciaio inox	1006382	49,00
Connettore IP68, 5 poli		
● nero	228725	17,90
Connettore IP68 a Y, 5 poli		
● nero	1006453	● 35,00



1006381 + 1006389 623 + 617



1006381 + 1006393 623 + 617

M-POL S Polehead

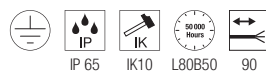
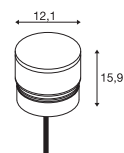

220-240V ~50/60Hz | 500mA
Potenza: 9W
Potenza assorbita: 11W
Materiale: alluminio



Down 470lm | 2700K | 510lm | 3000K

Versione	Articolo	EUR
● antracite	1006383	259,00



Articolo	Articolo	EUR
Palo		
● antracite		
H: 23,4 cm	1006379	99,00
● antracite		
H: 53,4 cm	1006380	139,00
● antracite		
H: 83,4 cm	1006381	169,00
Ancoraggio a terra		
● acciaio inox	1006382	49,00
Connettore IP68 a T, 3 poli		
● nero	228726	36,00
Connettore IP68, 3 poli		
● nero	228730	23,00



M-POL S Polehead, DALI

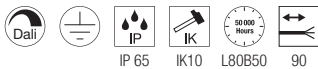
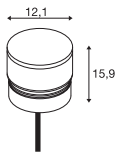

220-240V ~50/60Hz | 500mA
Potenza: 17W
Potenza assorbita: 19W
Materiale: alluminio



Down 890lm | 2700K | 950lm | 3000K

Versione	Articolo	EUR
● antracite	1006389	365,00



Articolo	Articolo	EUR
Palo		
● antracite		
H: 23,4 cm	1006379	99,00
● antracite		
H: 53,4 cm	1006380	139,00
● antracite		
H: 83,4 cm	1006381	169,00
Ancoraggio a terra		
● acciaio inox	1006382	49,00
Connettore IP68, 5 poli		
● nero	228725	17,90
Connettore IP68 a Y, 5 poli		
● nero	1006453	35,00

M-POL S Polehead, Shader

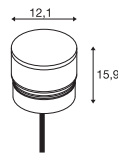

220-240V ~50/60Hz | 500mA
Potenza: 9W
Potenza assorbita: 11W
Materiale: alluminio



Down 285lm | 2700K | 310lm | 3000K

Versione	Articolo	EUR
● antracite	1006387	279,00



Articolo	Articolo	EUR
Palo		
● antracite		
H: 23,4 cm	1006379	99,00
● antracite		
H: 53,4 cm	1006380	139,00
● antracite		
H: 83,4 cm	1006381	169,00
Ancoraggio a terra		
● acciaio inox	1006382	49,00
Connettore IP68 a T, 3 poli		
● nero	228726	36,00
Connettore IP68, 3 poli		
● nero	228730	23,00

M-POL S Polehead, Shader, DALI

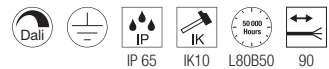
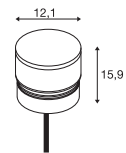

220-240V ~50/60Hz | 500mA
Potenza: 17W
Potenza assorbita: 19W
Materiale: alluminio



Down 520lm | 2700K | 550lm | 3000K

Versione	Articolo	EUR
● antracite	1006393	385,00



Articolo	Articolo	EUR
Palo		
● antracite		
H: 23,4 cm	1006379	99,00
● antracite		
H: 53,4 cm	1006380	139,00
● antracite		
H: 83,4 cm	1006381	169,00
Ancoraggio a terra		
● acciaio inox	1006382	49,00
Connettore IP68, 5 poli		
● nero	228725	17,90
Connettore IP68 a Y, 5 poli		
● nero	1006453	35,00

M-POL S
Polehead, Louver

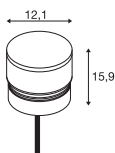

220-240V ~50/60Hz | 500mA
Potenza: 9W
Potenza assorbita: 11W
Materiale: alluminio



Down 145lm | 2700K 155lm | 3000K

Versione	Articolo	EUR
● antracite	1006385	315,00



Articolo	Articolo	EUR
Palo		
● antracite		
H: 23,4 cm	1006379	99,00
● antracite		
H: 53,4 cm	1006380	139,00
● antracite		
H: 83,4 cm	1006381	169,00
Ancoraggio a terra		
● acciaio inox	1006382	49,00
Connettore IP68 a T, 3 poli		
● nero	228726	36,00
Connettore IP68, 3 poli		
● nero	228730	23,00

M-POL S
Polehead, Louver, DALI

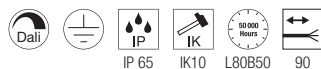
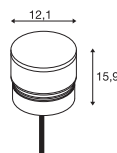

220-240V ~50/60Hz | 500mA
Potenza: 17W
Potenza assorbita: 19W
Materiale: alluminio



Down 260lm | 2700K 270lm | 3000K

Versione	Articolo	EUR
● antracite	1006391	449,00



Articolo	Articolo	EUR
Palo		
● antracite		
H: 23,4 cm	1006379	99,00
● antracite		
H: 53,4 cm	1006380	139,00
● antracite		
H: 83,4 cm	1006381	169,00
Ancoraggio a terra		
● acciaio inox	1006382	49,00
Connettore IP68, 5 poli		
● nero	228725	17,90
Connettore IP68 a Y, 5 poli		
● nero	1006453	35,00





M-POL M Polehead

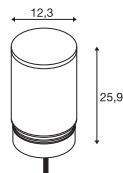

220-240V ~50/60Hz | 500mA
 Potenza: 9W
 Potenza assorbita: 11W
 Materiale: alluminio



Down 590lm | 2700K | 660lm | 3000K

Versione	Articolo	EUR
● antracite	1006384	279,00



Articolo	Articolo	EUR
Palo		
● antracite		
H: 23,4 cm	1006379	99,00
● antracite		
H: 53,4 cm	1006380	139,00
● antracite		
H: 83,4 cm	1006381	169,00
Ancoraggio a terra		
● acciaio inox	1006382	49,00
Connettore IP68 a T, 3 poli		
● nero	228726	36,00
Connettore IP68, 3 poli		
● nero	228730	23,00

M-POL M Polehead, DALI

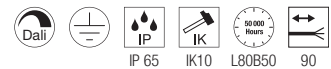
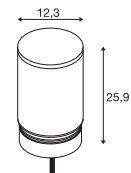

220-240V ~50/60Hz | 500mA
 Potenza: 17W
 Potenza assorbita: 19W
 Materiale: alluminio



Down 1150lm | 2700K | 1230lm | 3000K

Versione	Articolo	EUR
● antracite	1006390	385,00



Articolo	Articolo	EUR
Palo		
● antracite		
H: 23,4 cm	1006379	99,00
● antracite		
H: 53,4 cm	1006380	139,00
● antracite		
H: 83,4 cm	1006381	169,00
Ancoraggio a terra		
● acciaio inox	1006382	49,00
Connettore IP68, 5 poli		
● nero	228725	17,90
Connettore IP68 a Y, 5 poli		
● nero	1006453	35,00

1006379 + 1006390 623 + 619

1006379 + 1006384 623 + 619



M-POL M Polehead, Shader

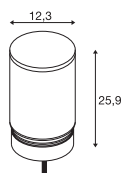

220-240V ~50/60Hz | 500mA
Potenza: 9W
Potenza assorbita: 11W
Materiale: alluminio



Down 420lm | 2700K | 460lm | 3000K

Versione	Articolo	EUR
● antracite	1006388	299,00



Articolo	Articolo	EUR
Palo		
● antracite	1006379	99,00
● antracite	1006380	139,00
● antracite	1006381	169,00
Ancoraggio a terra		
● acciaio inox	1006382	49,00
Connettore IP68 a T, 3 poli		
● nero	228726	36,00
Connettore IP68, 3 poli		
● nero	228730	23,00

M-POL M Polehead, Shader, DALI

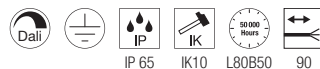
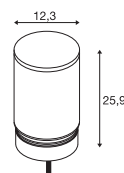

220-240V ~50/60Hz | 500mA
Potenza: 17W
Potenza assorbita: 19W
Materiale: alluminio



Down 820lm | 2700K | 870lm | 3000K

Versione	Articolo	EUR
● antracite	1006394	409,00



Articolo	Articolo	EUR
Palo		
● antracite	1006379	99,00
● antracite	1006380	139,00
● antracite	1006381	169,00
Ancoraggio a terra		
● acciaio inox	1006382	49,00
Connettore IP68, 5 poli		
● nero	228725	17,90
Connettore IP68 a Y, 5 poli		
● nero	1006453	35,00

1006381 + 1006388 623 + 620



M-POL M
Polehead, Louver

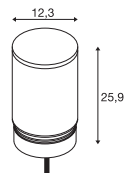

220-240V ~50/60Hz | 500mA
Potenza: 9W
Potenza assorbita: 11W
Materiale: alluminio



Down 190lm | 2700K | 210lm | 3000K

Versione	Articolo	EUR
● antracite	1006386	439,00



Articolo	Articolo	EUR
Palo		
● antracite		
H: 23,4 cm	1006379	99,00
● antracite		
H: 53,4 cm	1006380	139,00
● antracite		
H: 83,4 cm	1006381	169,00
Ancoraggio a terra		
● acciaio inox	1006382	49,00
Connettore IP68 a T, 3 poli		
● nero	228726	36,00
Connettore IP68, 3 poli		
● nero	228730	23,00

M-POL M
Polehead, Louver, DALI

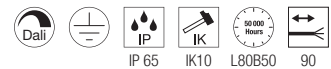
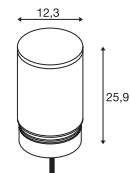

220-240V ~50/60Hz | 500mA
Potenza: 17W
Potenza assorbita: 19W
Materiale: alluminio



Down 350lm | 2700K | 370lm | 3000K

Versione	Articolo	EUR
● antracite	1006392	529,00



Articolo	Articolo	EUR
Palo		
● antracite		
H: 23,4 cm	1006379	99,00
● antracite		
H: 53,4 cm	1006380	139,00
● antracite		
H: 83,4 cm	1006381	169,00
Ancoraggio a terra		
● acciaio inox	1006382	49,00
Connettore IP68, 5 poli		
● nero	228725	17,90
Connettore IP68 a Y, 5 poli		
● nero	1006453	35,00

1006381 + 1006392 623 + 621



[1006380](tel:1006380) + [1006392](tel:1006392) - [623](tel:623) + [621](tel:621)



M-POL 30
Pole



M-POL 60
Pole



M-POL 90
Pole



Materiale: alluminio

Versione	Articolo	EUR
● antracite	1006379	99,00

Materiale: alluminio

Versione	Articolo	EUR
● antracite	1006380	139,00

Materiale: alluminio

Versione	Articolo	EUR
● antracite	1006381	169,00



Articolo	Articolo	EUR
Connettore IP68 a Y, 5-poli		
● nero	1006453 ●	35,00
Connettore IP68 a T, 3-poli		
● nero	228726	36,00
Connettore IP68, 3-poli		
● nero	228730	23,00



Articolo	Articolo	EUR
Connettore IP68 a Y, 5-poli		
● nero	1006453 ●	35,00
Connettore IP68 a T, 3-poli		
● nero	228726	36,00
Connettore IP68, 3-poli		
● nero	228730	23,00



Articolo	Articolo	EUR
Connettore IP68 a Y, 5-poli		
● nero	1006453 ●	35,00
Connettore IP68 a T, 3-poli		
● nero	228726	36,00
Connettore IP68, 3-poli		
● nero	228730	23,00

CONFIGURA IL TUO SISTEMA M-POL

Pochi passaggi sono sufficienti per ottenere il paletto luminoso perfetto: il sistema modulare M-POL consente di abbinare tre basi con altezze diverse e otto corpi lampada con cinque caratteristiche ottiche differenti e due temperature del colore. Questi ultimi disponibili in versione alta o bassa, con shader per un'illuminazione schermata su un lato, con irraggiamento omogeneo e diffuso oppure anti-abbagliamento grazie alle lamelle integrate. Temperatura del colore selezionabile a 2700 o 3000 K, versione on/off oppure DALI. Configura i tuoi paletti luminosi M-POL come preferisci e risalta ogni ambiente esterno con la luce migliore.

A TE LA SCELTA:

- 1 Paletto (30, 60, 90)
- 2 Controllo (on/off, DALI)
- 3 Dimensione del corpo lampada (alto, basso)
- 4 Caratteristiche ottiche (Clear, Shader, Louver)
- 5 Temperatura del colore (2700K/3000K)



FATTO!

CORPI LAMPADA

M-POL S

Ø: 12,3 cm, H: 15,9 cm

M-POL M

Ø: 12,3 cm, H: 25,9 cm

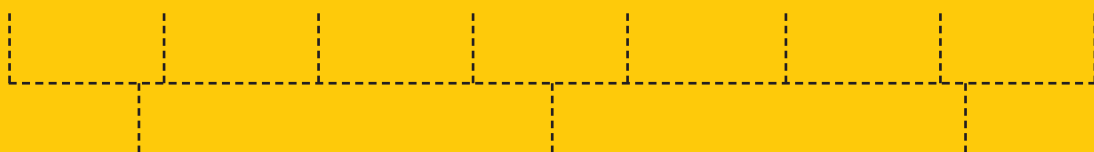
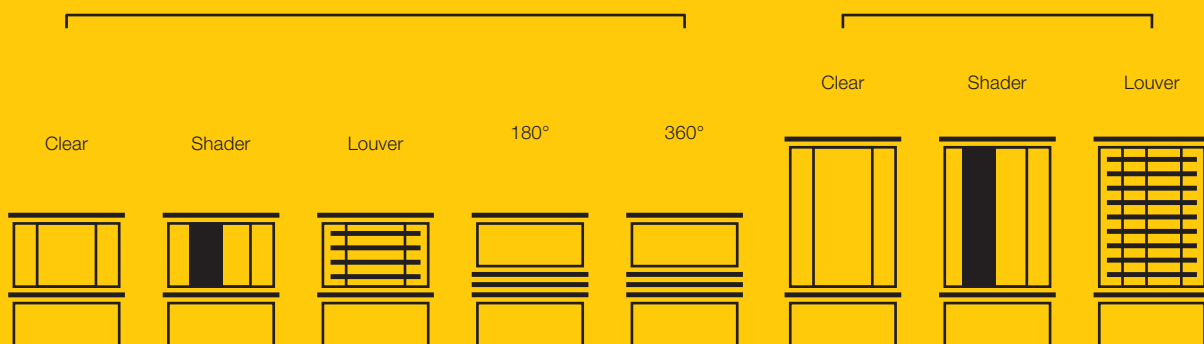

M-POL 30
Ø: 12,4 cm, H: 23,4 cm

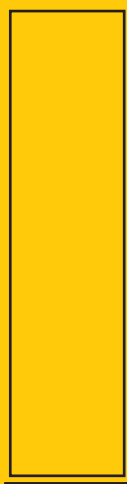

M-POL 60
Ø: 12,4 cm, H: 53,4 cm



M-POL 90
Ø: 12,4 cm, H: 83,4 cm



1006408 627



CONCRETO
FL, rotondo, QPAR 51

CONCRETO
FL, quadrato, QPAR51

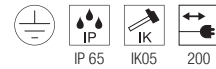
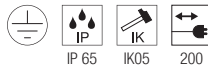
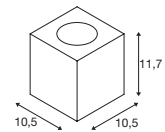
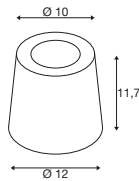

220-240V ~50/60Hz
Materiale: calcestruzzo/alluminio

220-240V ~50/60Hz
Materiale: calcestruzzo/alluminio

- Spina Schuko IP44

- Spina Schuko IP44



Attacco: 1xGU10 max. Ø: 5,1 cm L: 6 cm

Attacco: 1xGU10 max. Ø: 5,1 cm L: 6 cm

Versione	Articolo	EUR
● grigio	1006408	120,00

Versione	Articolo	EUR
● grigio	1006409	120,00



LED GU10 51mm | 6W | 38°
2700K | 450lm | Classe=F
6kWh/1000h



Articolo: 1005077 | 7,50 EUR



LED GU10 51mm | 6W | 38°
2700K | 450lm | Classe=F
6kWh/1000h



Articolo: 1005077 | 7,50 EUR



1004749 629



1004750 629



ESKINA FRAME 45 Pole, single

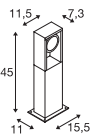

220-240V ~50/60Hz | 350mA
Potenza assorbita: 15W
Materiale: alluminio



Down 1100lm | 3000K | 1200lm | 4000K

Versione	Articolo	EUR
● antracite	1004749	282,00



Articolo	Articolo	EUR
Connettore IP68, 3 poli		
● nero	228730	23,00

ESKINA FRAME 75 Pole, single

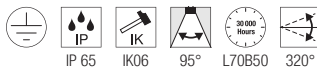
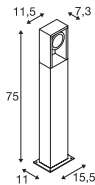

220-240V ~50/60Hz | 350mA
Potenza assorbita: 15W
Materiale: alluminio



Down 1100lm | 3000K | 1200lm | 4000K

Versione	Articolo	EUR
● antracite	1004750	308,00



Articolo	Articolo	EUR
Connettore IP68, 3 poli		
● nero	228730	23,00

ESKINA FRAME 75 Pole, double

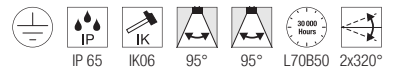
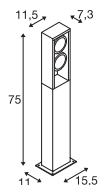

220-240V ~50/60Hz | 700mA
Potenza assorbita: 27W
Materiale: alluminio



Spot 1 1100lm | 3000K | 1200lm | 4000K
Spot 2 1100lm | 3000K | 1200lm | 4000K

Versione	Articolo	EUR
● antracite	1004751	349,00



Articolo	Articolo	EUR
Connettore IP68, 3 poli		
● nero	228730	23,00

ESKINA FRAME 125
Pole, double

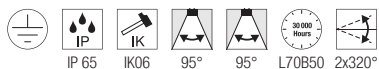
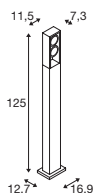

220-240V ~50/60Hz | 700mA
Potenza assorbita: 27W
Materiale: alluminio



Spot 1	1100lm	3000K	1200lm	4000K
Spot 2	1100lm	3000K	1200lm	4000K

Versione	Articolo	EUR
● antracite	1005439	403,00



Articolo	Articolo	EUR
● nero	228730	23,00

ESKINA FRAME 175
Pole, double

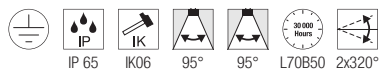
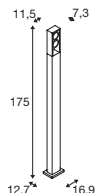

220-240V ~50/60Hz | 700mA
Potenza assorbita: 27W
Materiale: alluminio



Spot 1	1100lm	3000K	1200lm	4000K
Spot 2	1100lm	3000K	1200lm	4000K

Versione	Articolo	EUR
● antracite	1005440	474,00



Articolo	Articolo	EUR
● nero	228730	23,00

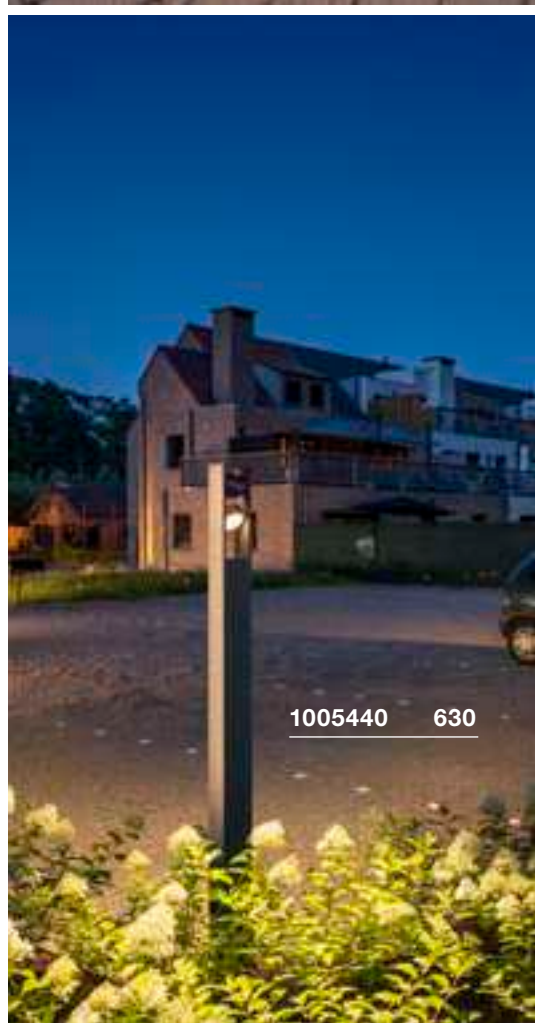
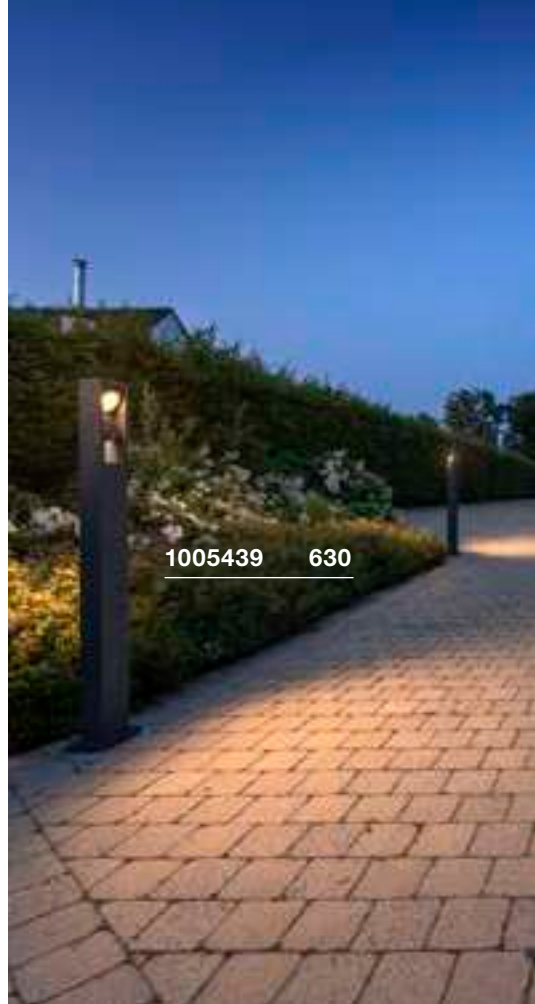



1002906 631

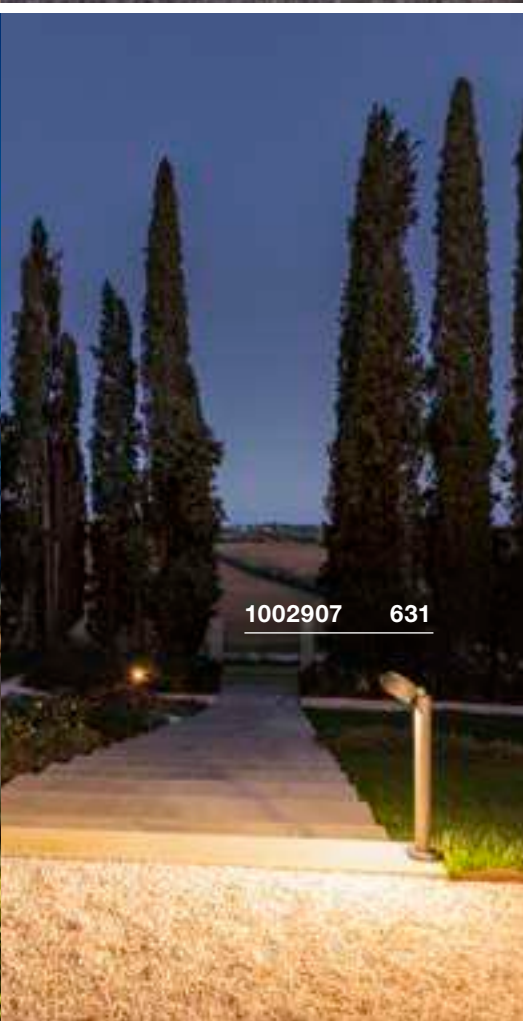

1002907 631

ESKINA 30 Pole

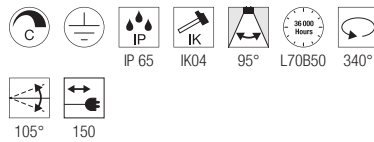
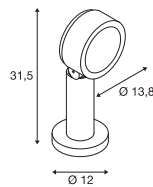

220-240V ~50/60Hz | 350mA
Potenza assorbita: 14,5W
Materiale: alluminio

- Spina Schuko IP44



Down 1000lm | 3000K | 4000K

Versione	Articolo	EUR
● antracite	1002906	282,00



Articolo	Articolo	EUR
Picchetto		
● grigio	230060	53,00

ESKINA 80 Pole

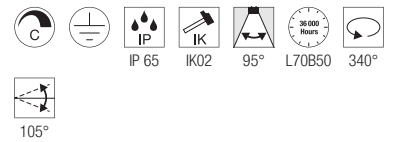
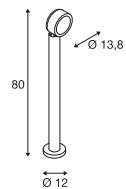

220-240V ~50/60Hz | 350mA
Potenza assorbita: 14,5W
Materiale: alluminio



Down 1000lm | 3000K | 4000K

Versione	Articolo	EUR
● antracite	1002907	308,00



Articolo	Articolo	EUR
Picchetto		
● grigio	230060	53,00
Connettore IP68, 3 poli		
● nero	228730	23,00



232115

633



232125

633



LOGS 40 Pole

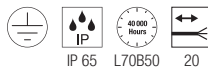
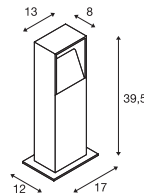

220-240V ~50/60Hz | 500mA
Potenza assorbita: 9,5W
Materiale: alluminio

- Cavo con terminale aperto



Down 570lm | 3000K

Versione	Articolo	EUR
● antracite	232115	259,00



Articolo	Articolo	EUR
Ancoraggi per cemento		
● grigio	232119	61,00
Picchetto		
● grigio	231230	45,50
Set di viti		
● acciaio inox	228754	4,50
Connettore IP68, 3 poli		
● nero	228730	23,00

LOGS 70 Pole

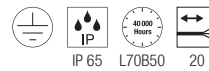
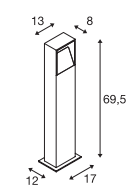

220-240V ~50/60Hz | 500mA
Potenza assorbita: 9,5W
Materiale: alluminio

- Cavo con terminale aperto



Down 570lm | 3000K

Versione	Articolo	EUR
● antracite	232125	299,00



Articolo	Articolo	EUR
Ancoraggi per cemento		
● grigio	232119	61,00
Picchetto		
● grigio	231230	45,50
Set di viti		
● acciaio inox	228754	4,50
Connettore IP68, 3 poli		
● nero	228730	23,00

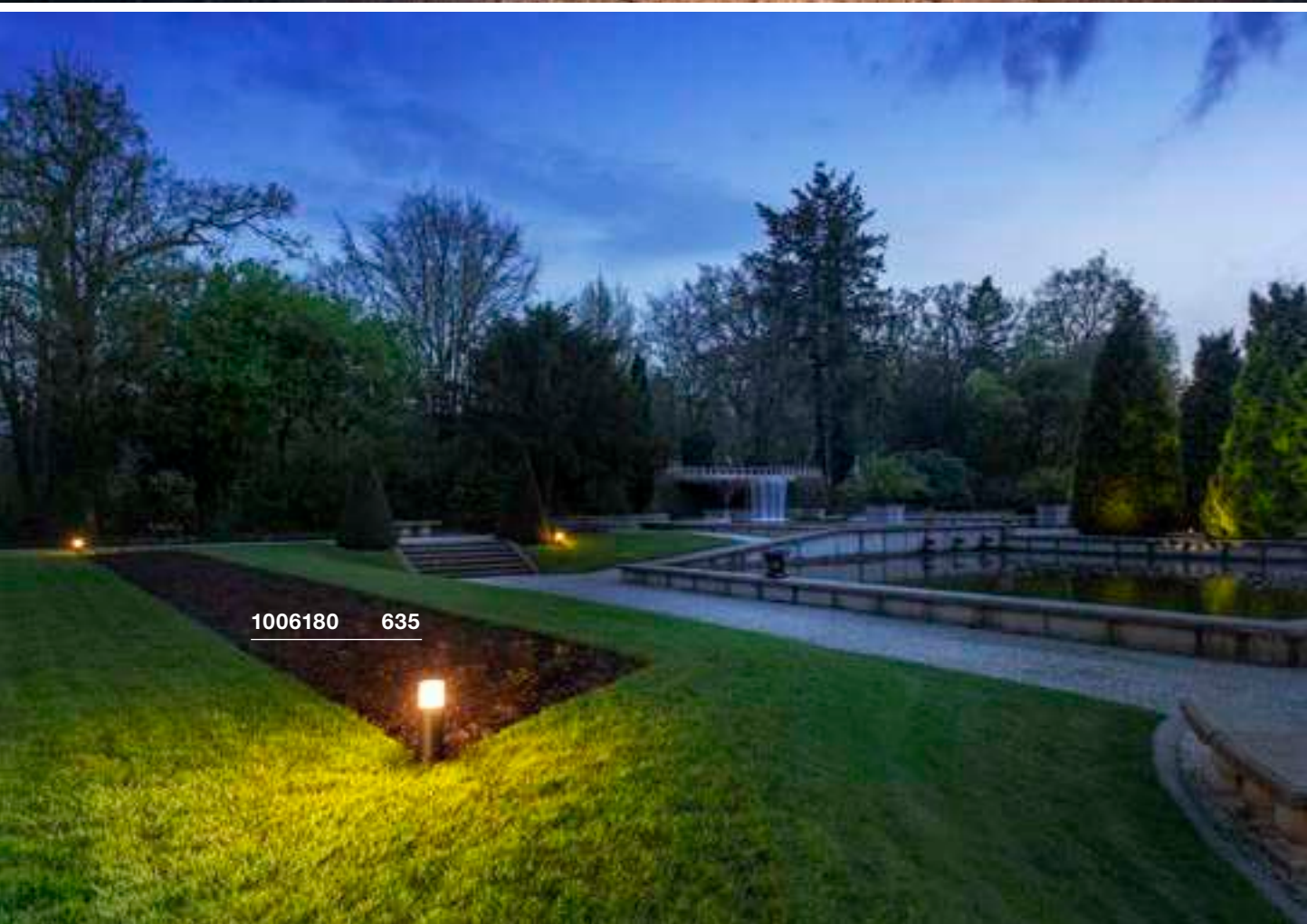



GRAFIT 30
Pole, rotondo, E27

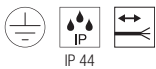
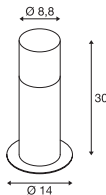

220-240V ~50/60Hz
Materiale: alluminio/acrilico

- Cavo con terminale aperto



Attacco: 1xE27 Ø max.: 6 cm L: 11,5 cm

Versione	Articolo	EUR
● antracite	1006180	80,00



LED E27 | 8W | 240°
3000K | 880lm | Classe=E
8kWh/1000h



Articolo: 1005289 | 10,25 EUR



Articolo	Articolo	EUR
● Connettore IP68, 3 poli nero	228730	23,00

GRAFIT 60
Pole, rotondo, E27

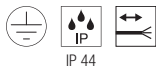
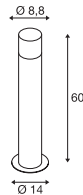

220-240V ~50/60Hz
Materiale: alluminio/acrilico

- Cavo con terminale aperto



Attacco: 1xE27 Ø max.: 6 cm L: 11,5 cm

Versione	Articolo	EUR
● antracite	1006181	100,00



LED E27 | 8W | 240°
3000K | 880lm | Classe=E
8kWh/1000h



Articolo: 1005289 | 10,25 EUR



Articolo	Articolo	EUR
● Connettore IP68, 3 poli nero	228730	23,00

GRAFIT 90
Pole, rotondo, E27

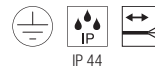
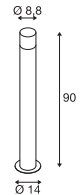

220-240V ~50/60Hz
Materiale: alluminio/acrilico

- Cavo con terminale aperto



Attacco: 1xE27 Ø max.: 6 cm L: 11,5 cm

Versione	Articolo	EUR
● antracite	1006182	131,00



LED E27 | 8W | 240°
3000K | 880lm | Classe=E
8kWh/1000h



Articolo: 1005289 | 10,25 EUR



Articolo	Articolo	EUR
● Connettore IP68, 3 poli nero	228730	23,00



231225 637



1006184 637



GRAFIT 30 Pole, E27

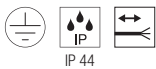
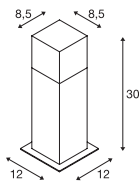

220-240V ~50/60Hz
Materiale: alluminio/plastica

- Cavo con terminale aperto



Attacco: 1xE27 Ø max.: 6 cm L: 11,5 cm

Versione	Articolo	EUR
● antracite	231215	80,00



LED E27 | 8W | 240°
3000K | 880lm | Classe=E
8kWh/1000h



Articolo: 1005289 | 10,25 EUR



Articolo	Articolo	EUR
Picchetto		
● grigio	231230	45,50
Set di viti		
● acciaio inox	228754	4,50
Connettore IP68, 3 poli		
● nero	228730	23,00

GRAFIT 60 Pole, E27

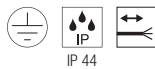
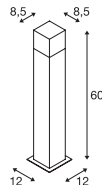

220-240V ~50/60Hz
Materiale: alluminio/plastica

- Cavo con terminale aperto



Attacco: 1xE27 Ø max.: 6 cm L: 11,5 cm

Versione	Articolo	EUR
● antracite	231225	100,00



LED E27 | 8W | 240°
3000K | 880lm | Classe=E
8kWh/1000h



Articolo: 1005289 | 10,25 EUR



Articolo	Articolo	EUR
Picchetto		
● grigio	231230	45,50
Set di viti		
● acciaio inox	228754	4,50
Connettore IP68, 3 poli		
● nero	228730	23,00

GRAFIT 90 Pole, E27

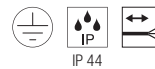
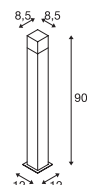

220-240V ~50/60Hz
Materiale: alluminio/acrilico

- Cavo con terminale aperto



Attacco: 1xE27 Ø max.: 6 cm L: 11,5 cm

Versione	Articolo	EUR
● antracite	1006184	131,00



LED E27 | 8W | 240°
3000K | 880lm | Classe=E
8kWh/1000h



Articolo: 1005289 | 10,25 EUR



Articolo	Articolo	EUR
Picchetto		
● grigio	231230	45,50
Connettore IP68, 3 poli		
● nero	228730	23,00



1005442 639



QUADRULO FL

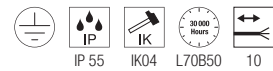
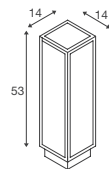

IP 55 IK04 L70B50 10

100-277V ~50/60Hz | 480mA

Potenza assorbita: 7W

Materiale: alluminio/acrilico

- Connettore IP68 incluso



Down

340lm | 3000K

Versione	Articolo	EUR
● antracite	1005442	166,00

RUSTY® SLOT 50 Pole

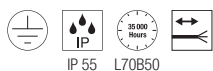
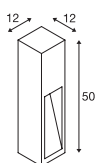

220-240V ~50/60Hz
Potenza assorbita: 9W
Materiale: acciaio FeCSi/policarbonato (PC)

- Cavo con terminale aperto



Down 30lm | 3000K

Versione	Articolo	EUR
● ruggine	233447	309,00



Articolo	Articolo	EUR
Picchetto		
● grigio	231230	45,50
Connettore IP68, 3 poli		
● nero	228730	23,00

RUSTY® SLOT 80 Pole

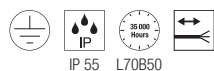
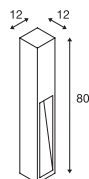

220-240V ~50/60Hz
Potenza assorbita: 9W
Materiale: acciaio FeCSi/policarbonato (PC)

- Cavo con terminale aperto



Down 30lm | 3000K

Versione	Articolo	EUR
● ruggine	233457	389,00



Articolo	Articolo	EUR
Picchetto		
● grigio	231230	45,50
Connettore IP68, 3 poli		
● nero	228730	23,00



229410 641

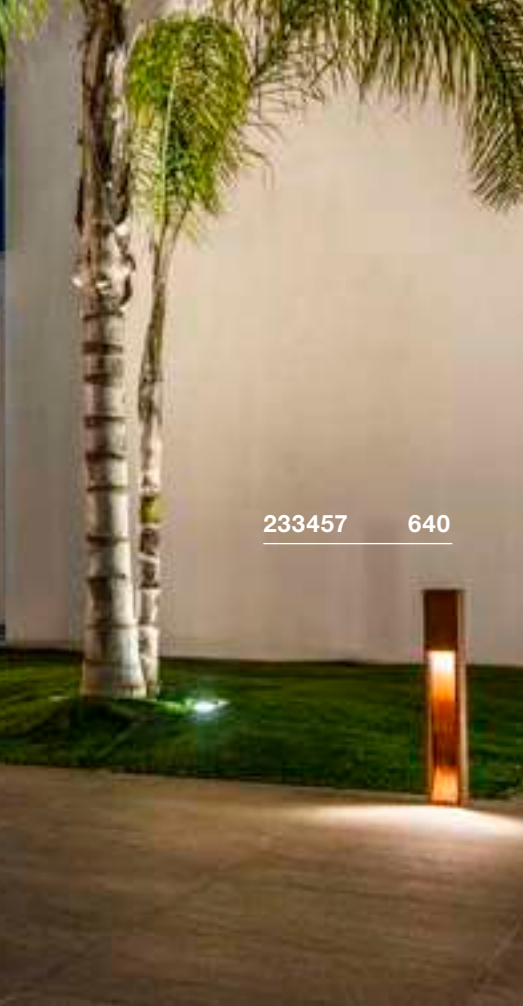

233457 640

RUSTY® SLOT 50
Pole, E27

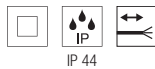
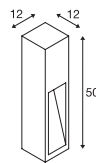

220-240V ~50/60Hz
Materiale: acciaio FeCSI/policarbonato (PC)

- Cavo con terminale aperto



Attacco: 1xE27 Ø max.: 4,8 cm L: 13,9 cm

Versione	Articolo	EUR
● ruggine	229410	286,00



LED E27 | 8W | 240°
3000K | 880lm | Classe=E
8kWh/1000h



Articolo: 1005289 | 10,25 EUR



Articolo	Articolo	EUR
Picchetto		
● grigio	231230	45,50
Connettore IP68, 3 poli		
● nero	228730	23,00



229411 641

RUSTY® SLOT 80
Pole, E27

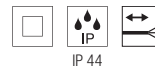
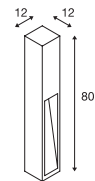

220-240V ~50/60Hz
Materiale: acciaio FeCSI/policarbonato (PC)

- Cavo con terminale aperto



Attacco: 1xE27 Ø max.: 4,8 cm L: 13,9 cm

Versione	Articolo	EUR
● ruggine	229411	360,00



LED E27 | 8W | 240°
4000K | 920lm | Classe=E
8kWh/1000h



Articolo: 1005290 | 10,25 EUR



Articolo	Articolo	EUR
Picchetto		
● grigio	231230	45,50
Connettore IP68, 3 poli		
● nero	228730	23,00



233090 642



229420 643

RUSTY® PATHLIGHT Pole, TCR-TSE

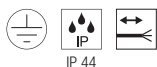
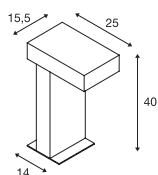

220-240V ~50/60Hz
Materiale: acciaio FeCSI/policarbonato (PC)

- Cavo con terminale aperto



Attacco: 1xGX53 Ø max.: 7,5 cm L: 2,7 cm

Versione	Articolo	EUR
● ruggine	230090	312,00



LED GX53 | 6,1W | 120°
3000K | 490lm | Classe=G
6kWh/1000h



Articolo: 1005271 | 11,50 EUR



Articolo	Articolo	EUR
Picchetto		
● grigio	229422	45,50
Connettore IP68, 3 poli		
● nero	228730	23,00

RUSTY® 40 Pole

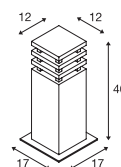

220-240V ~50/60Hz
Potenza assorbita: 9W
Materiale: acciaio FeCSI/policarbonato (PC)

- Cavo con terminale aperto



Down 90lm | 3000K

Versione	Articolo	EUR
● ruggine	233427	309,00



Articolo	Articolo	EUR
Picchetto		
● grigio	229422	45,50
Connettore IP68, 3 poli		
● nero	228730	23,00



RUSTY® 70 Pole

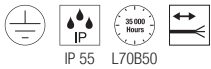
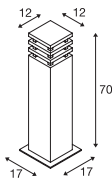

220-240V ~50/60Hz
Potenza assorbita: 9W
Materiale: acciaio FeCSi/polycarbonato (PC)

- Cavo con terminale aperto



Down 90lm | 3000K

Versione	Articolo	EUR
● ruggine	233437	389,00



Articolo	Articolo	EUR
Picchetto		
● grigio	229422	45,50
Connettore IP68, 3 poli		
● nero	228730	23,00

RUSTY® 40 Pole, E27

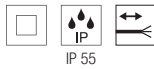
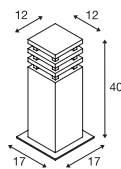

220-240V ~50/60Hz
Materiale: acciaio FeCSi/polycarbonato (PC)

- Cavo con terminale aperto



Attacco: 1xE27 Ø max.: 4,8 cm | L: 13,9 cm

Versione	Articolo	EUR
● ruggine	229420	286,00



LED E27 | 8W | 240°
3000K | 880lm | Classe=E
8kWh/1000h



Articolo: 1005289 | 10,25 EUR



Articolo	Articolo	EUR
Picchetto		
● grigio	229422	45,50
Connettore IP68, 3 poli		
● nero	228730	23,00

RUSTY® 70 Pole, E27

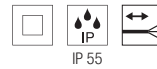
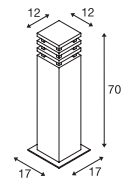

220-240V ~50/60Hz
Materiale: acciaio FeCSi/polycarbonato (PC)

- Cavo con terminale aperto



Attacco: 1xE27 Ø max.: 4,8 cm | L: 13,9 cm

Versione	Articolo	EUR
● ruggine	229421	360,00



LED E27 | 8W | 240°
4000K | 920lm | Classe=E
8kWh/1000h



Articolo: 1005290 | 10,25 EUR



Articolo	Articolo	EUR
Picchetto		
● grigio	229422	45,50
Connettore IP68, 3 poli		
● nero	228730	23,00





RUSTY® CONE 24 FL, E14

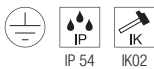
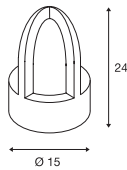

220-240V ~50/60Hz
Materiale: acciaio FeCSI/vetro



Attacco: 1xE14 Ø max.: 4,8 cm L: 13,9 cm

Versione	Articolo	EUR
● ruggine	229430	276,00



C35 | 4,2W | 320°
2700K | 350lm | Classe=G
5kWh/1000h



Articolo: 1005285 | 8,50 EUR

RUSTY® CONE 40 Pole, E27

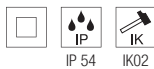
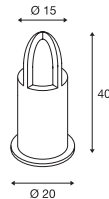

220-240V ~50/60Hz
Materiale: acciaio FeCSI/vetro



Attacco: 1xE27 Ø max.: 4,8 cm L: 13,9 cm

Versione	Articolo	EUR
● ruggine	229431	419,00



LED E27 | 8W | 240°
3000K | 880lm | Classe=E
8kWh/1000h



Articolo: 1005289 | 10,25 EUR



Articolo	Articolo	EUR
Picchetto		
● grigio	229422	45,50
Connettore IP68, 3 poli		
● nero	228730	23,00

RUSTY® CONE 70 Pole, E27

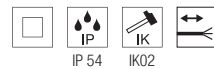
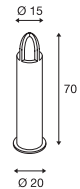

220-240V ~50/60Hz
Materiale: acciaio FeCSI/policarbonato (PC)



Attacco: 1xE27 Ø max.: 4,8 cm L: 13,9 cm

Versione	Articolo	EUR
● ruggine	229432	499,00



LED E27 | 8W | 240°
3000K | 880lm | Classe=E
8kWh/1000h



Articolo: 1005289 | 10,25 EUR



Articolo	Articolo	EUR
Picchetto		
● grigio	229422	45,50
Connettore IP68, 3 poli		
● nero	228730	23,00

RUSTY® 40
Pole, E27

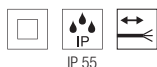
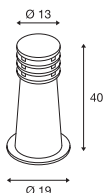

220-240V ~50/60Hz
Materiale: acciaio FeCSi/policarbonato (PC)

- Cavo con terminale aperto



Attacco: 1xE27 Ø max.: 4,8 cm L: 13,9 cm

Versione	Articolo	EUR
● ruggine	229020	286,00



LED E27 | 8W | 240°
4000K | 920lm | Classe=E
8kWh/1000h



Articolo: 1005290 | 10,25 EUR



Articolo	Articolo	EUR
Picchetto		
● acciaio inox	229022	49,50
Connettore IP68, 3 poli		
● nero	228730	23,00

RUSTY® 70
Pole, E27

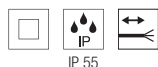
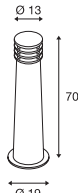

220-240V ~50/60Hz
Materiale: acciaio FeCSi/policarbonato (PC)

- Cavo con terminale aperto



Attacco: 1xE27 Ø max.: 4,8 cm L: 13,9 cm

Versione	Articolo	EUR
● ruggine	229021	360,00



LED E27 | 8W | 240°
3000K | 880lm | Classe=E
8kWh/1000h



Articolo: 1005289 | 10,25 EUR



Articolo	Articolo	EUR
Picchetto		
● acciaio inox	229022	49,50
Connettore IP68, 3 poli		
● nero	228730	23,00



229020 646

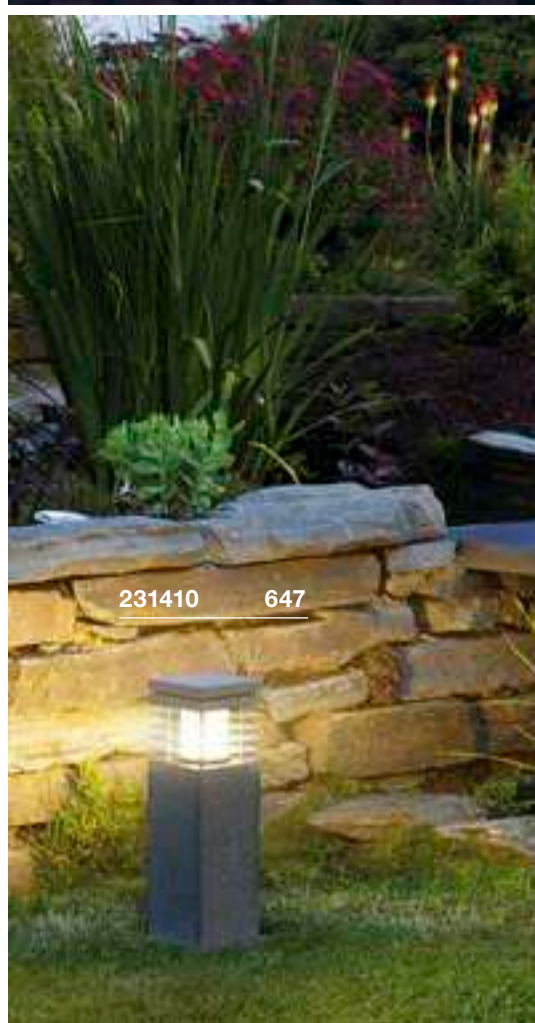

231410 647



229021 646

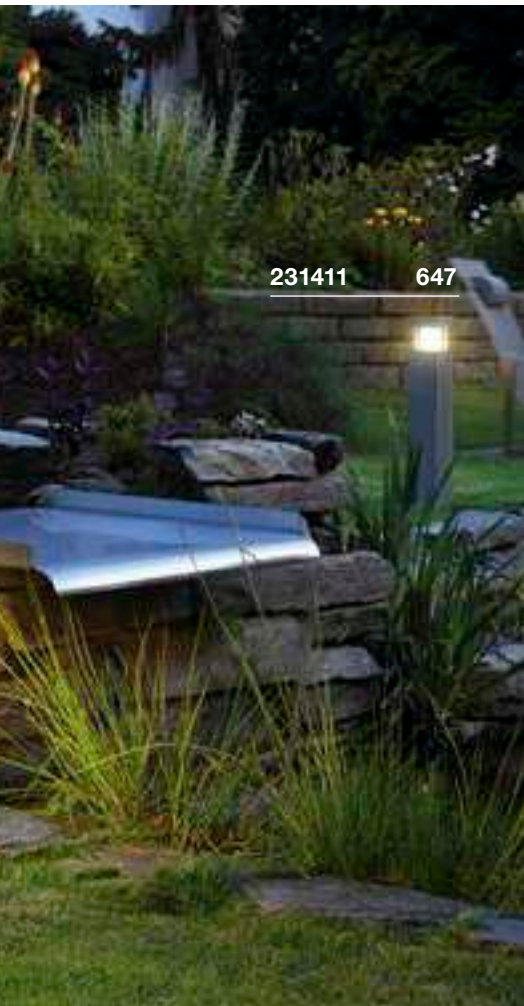

231411 647

ARROCK GRANITE 40
Pole, square, E27

ARROCK GRANITE 70
Pole, square, E27

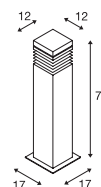
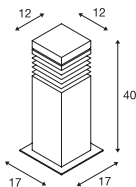

IP 44

220-240V ~50/60Hz
Materiale: granito/acciaio inox 304



IP 44

220-240V ~50/60Hz
Materiale: granito/acciaio inox 304



Attacco: 1xE27 Ø max.: 5,2 cm L: 11,5 cm

Versione	Articolo	EUR
● grigio	231410	359,00



Attacco: 1xE27 Ø max.: 5,2 cm L: 11,5 cm

Versione	Articolo	EUR
● grigio	231411	434,00



LED E27 | 8W | 240°
3000K | 880lm | Classe=E
8kWh/1000h



Articolo: 1005289 | 10,25 EUR



LED E27 | 8W | 240°
4000K | 920lm | Classe=E
8kWh/1000h



Articolo: 1005290 | 10,25 EUR



Articolo	Articolo	EUR
Picchetto		
● acciaio inox	229022	49,50
Connettore IP68, 3 poli		
● nero	228730	23,00



Articolo	Articolo	EUR
Picchetto		
● acciaio inox	229022	49,50
Connettore IP68, 3 poli		
● nero	228730	23,00

ARROCK ARC
Pole, QPAR51

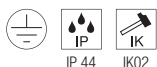
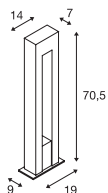

220-240V ~50/60Hz
Materiale: granito/acciaio inox 304



Attacco: 1xGU10 max. Ø: 5,1 cm | L: 7,6 cm

Versione	Articolo	EUR
● grigio	231420	359,00



LED GU10 51mm | 6W | 38°
2700K | 450lm | Classe=F
6kWh/1000h



Articolo: 1005075 | 7,50 EUR



Articolo	Articolo	EUR
Picchetto		
● grigio	231233	49,50



231420 648



231371 649



231440 649



ARROCK STONE 50 Pole

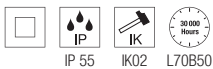
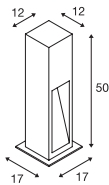

220-240V ~50/60Hz | 700mA
Potenza assorbita: 9W
Materiale: basalto/acciaio inox 304



Down 330lm | 3000K

Versione	Articolo	EUR
● grigio	231370	413,00



Articolo	Articolo	EUR
Picchetto		
● grigio	231233	49,50

ARROCK STONE 75 Pole

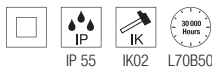
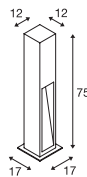

220-240V ~50/60Hz | 700mA
Potenza assorbita: 9W
Materiale: basalto/acciaio inox 304



Down 330lm | 3000K

Versione	Articolo	EUR
● grigio	231371	474,00



Articolo	Articolo	EUR
Picchetto		
● grigio	231233	49,50

ARROCK SLOT Pole, QPAR51

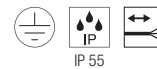
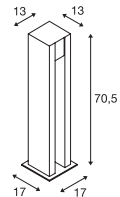

220-240V ~50/60Hz
Materiale: granito/acciaio inox 304
● Cavo con terminale aperto



Attacco: 1xGU10

Versione	Articolo	EUR
● grigio	231440	413,00



LED GU10 51mm | 6W | 38°
2700K | 450lm | Classe=F
6kWh/1000h



Articolo: 1005076 | 7,50 EUR



Articolo	Articolo	EUR
Picchetto		
● grigio	231235	49,50
Connettore IP68, 3 poli		
● nero	228730	23,00



1003535 651

L-LINE OUT 30 FL, verticale

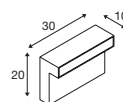

1003538 651



220-240V ~50/60Hz | 500mA
Potenza assorbita: 11,5 W
Materiale: alluminio/policarbonato (PC)

- Temperatura del colore selezionabile prima dell'installazione tramite il selettore posizionato all'interno dell'alloggiamento
- Cavo con terminale aperto



CRI
80

Down 800lm | 3000K | 810lm | 4000K

Versione	Articolo	EUR
● antracite	1003536	232,00



Articolo	Articolo	EUR
Connettore IP68, 3 poli		
● nero	228730	23,00



L-LINE OUT 60
FL, verticale

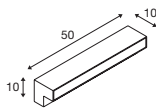

220-240V ~50/60Hz | 500mA
Potenza assorbita: 11,5 W
Materiale: alluminio/polycarbonato (PC)

- Temperatura del colore selezionabile prima dell'installazione tramite il selettore posizionato all'interno dell'alloggiamento
- Cavo con terminale aperto



Down 780lm | 3000K | 800lm | 4000K

Versione	Articolo	EUR
● antracite	1003535	242,00



Articolo	Articolo	EUR
Connettore IP68, 3 poli		
● nero	228730	23,00

L-LINE OUT 50
Pole, orizzontale

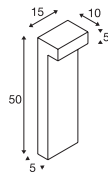

220-240V ~50/60Hz | 350mA
Potenza assorbita: 7W
Materiale: alluminio/polycarbonato (PC)

- Temperatura del colore selezionabile prima dell'installazione tramite il selettore posizionato all'interno dell'alloggiamento
- Cavo con terminale aperto



Down 490lm | 3000K | 530lm | 4000K

Versione	Articolo	EUR
● antracite	1003537	191,00



Articolo	Articolo	EUR
Connettore IP68, 3 poli		
● nero	228730	23,00

L-LINE OUT 80
Pole, orizzontale

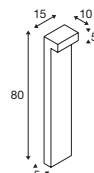

220-240V ~50/60Hz | 350mA
Potenza assorbita: 7W
Materiale: alluminio/polycarbonato (PC)

- Temperatura del colore selezionabile prima dell'installazione tramite il selettore posizionato all'interno dell'alloggiamento
- Cavo con terminale aperto



Down 490lm | 3000K | 530lm | 4000K

Versione	Articolo	EUR
● antracite	1003538	222,00



Articolo	Articolo	EUR
Connettore IP68, 3 poli		
● nero	228730	23,00

THEO PATHLIGHT

Pole, double

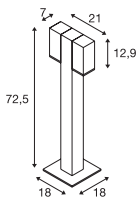

220-240V ~50/60Hz
Materiale: alluminio



Attacco: 2xGU10

Versione	Articolo	EUR
● antracite	1002871	239,00



LED GU10 51mm | 6W | 38°
2700K | 450lm | Classe=F
6kWh/1000h



Articolo: 1005077 | 7,50 EUR



Articolo	Articolo	EUR
● Connettore IP68, 3 poli nero	228730	23,00

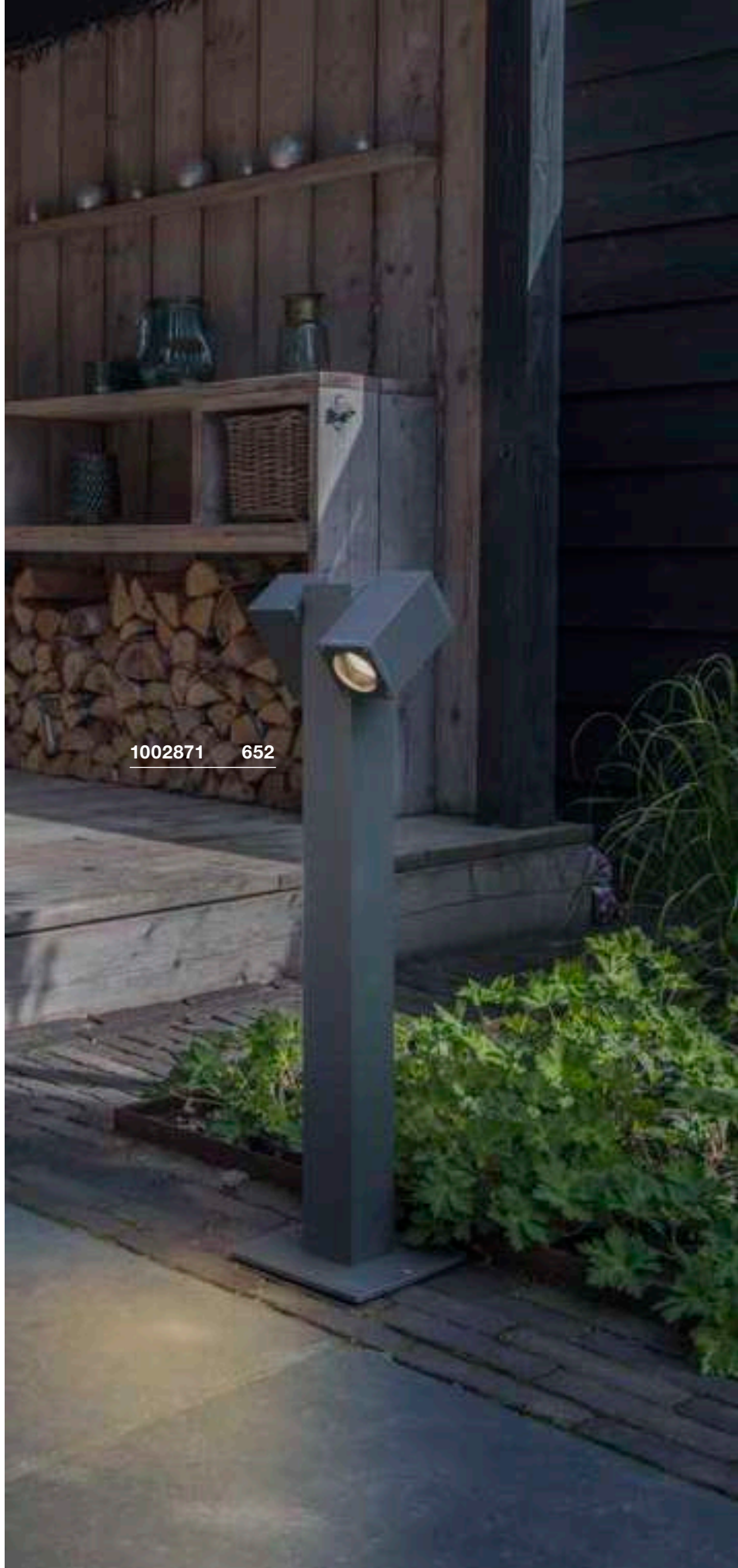

1002871 652



OVALISK 75 Pole

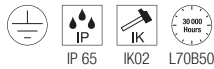
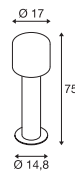

220-240V ~50/60Hz | 500mA
Potenza assorbita: 9,2W
Materiale: alluminio/vetro



Down 580lm | 3000K | 630lm | 4000K

Versione	Articolo	EUR
● antracite	1004680	332,00



Articolo	Articolo	EUR
Ancoraggi per cemento		
● argento	228712	64,00
Picchetto		
● grigio	228722	58,00
Connettore IP68, 3 poli		
● nero	228730	23,00

OVALISK 100 Pole

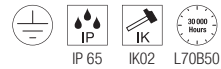
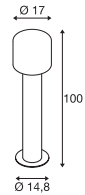

220-240V ~50/60Hz | 500mA
Potenza assorbita: 9,2W
Materiale: alluminio/vetro



Down 580lm | 3000K | 630lm | 4000K

Versione	Articolo	EUR
● antracite	1004681	362,00

1004680 653



1002000 655



1002001 655



GLOO PURE 27 Pole, E27

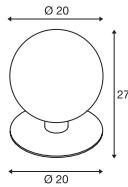

220-240V ~50/60Hz
Materiale: alluminio/vetro

- Cavo con terminale aperto



Attacco: 1xE27 Ø max.: 4,8 cm L: 18 cm

Versione	Articolo	EUR
● antracite	1001999	93,00

| 13,5W | 240°
3000K | 1520lm | Classe=E
14kWh/1000h

Articolo: 1005307 | 12,50 EUR

Articolo	Articolo	EUR
Picchetto		
● grigio	231234	52,00
Connettore IP68, 3 poli		
● nero	228730	23,00

GLOO PURE 44 Pole, E27

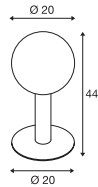

220-240V ~50/60Hz
Materiale: alluminio/vetro

- Cavo con terminale aperto



Attacco: 1xE27 Ø max.: 4,8 cm L: 18 cm

Versione	Articolo	EUR
● antracite	1002000	124,00

| LED E27 | 8W | 240°
3000K | 880lm | Classe=E
8kWh/1000h

Articolo: 1005289 | 10,25 EUR

Articolo	Articolo	EUR
Picchetto		
● grigio	231234	52,00
Connettore IP68, 3 poli		
● nero	228730	23,00

GLOO PURE 70 Pole, E27

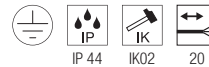
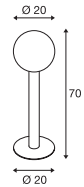

220-240V ~50/60Hz
Materiale: alluminio/vetro

- Cavo con terminale aperto



Attacco: 1xE27 Ø max.: 4,8 cm L: 18 cm

Versione	Articolo	EUR
● antracite	1002001	136,00

| 13,5W | 240°
3000K | 1520lm | Classe=E
14kWh/1000h

Articolo: 1005307 | 12,50 EUR

Articolo	Articolo	EUR
Picchetto		
● grigio	231234	52,00
Connettore IP68, 3 poli		
● nero	228730	23,00



227221 657

227219 657



ROTOBALL 25 FL, E27

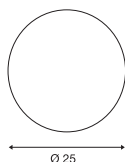

220-240V ~50/60Hz
Materiale: acciaio/polietilene (PE)

- Spina Schuko IP44



Attacco: 1xE27

Versione	Articolo	EUR
○ bianco	227219	161,00



A60 | 7,5W | 320°
2700K | 800lm | Classe=F
8kWh/1000h



Articolo: 1005303 | 9,60 EUR

ROTOBALL 40 FL, E27

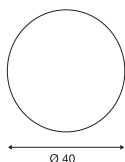

220-240V ~50/60Hz
Materiale: acciaio/polietilene (PE)

- Spina Schuko IP44



Attacco: 1xE27

Ø max.: 9,5 cm

Versione	Articolo	EUR
○ bianco	227220	181,00



LED E27 | 8W | 240°
3000K | 880lm | Classe=E
8kWh/1000h



Articolo: 1005289 | 10,25 EUR

ROTOBALL 50 FL, E27

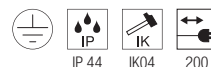
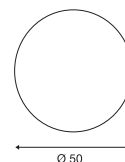

220-240V ~50/60Hz
Materiale: acciaio/polietilene (PE)

- Spina Schuko IP44



Attacco: 1xE27

Ø max.: 9,5 cm

Versione	Articolo	EUR
○ bianco	227221	242,00



A60 | 7,5W | 320°
2700K | 800lm | Classe=F
8kWh/1000h



Articolo: 1005303 | 9,60 EUR



232065 659



232075 659



230465 659



PHOTONIA PD, E27

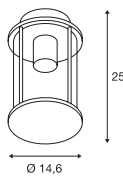

220-240V ~50/60Hz
Materiale: alluminio/vetro

- Catena per sospensione inclusa
- Spina Schuko IP44



Attacco: 1xE27 Ø max.: 9 cm L: 15 cm

Versione	Articolo	EUR
● antracite	232065	239,00



LED E27 | 7,5W | 320°
2700K | 800lm | Classe=F
8kWh/1000h



Articolo: 1005268 | 12,25 EUR



Articolo	Articolo	EUR
Rosone		
● antracite	1000398	80,00

PHOTONIA Pole, E27



220-240V ~50/60Hz
Materiale: alluminio/vetro

- Cavo con terminale aperto



Attacco: 1xE27 Ø max.: 9 cm L: 15 cm

Versione	Articolo	EUR
● antracite	232075	275,00



LED E27 | 7,5W | 320°
2500K | 700lm | Classe=F
8kWh/1000h



Articolo: 1005265 | 26,50 EUR



Articolo	Articolo	EUR
Ancoraggi per cemento		
● acciaio inox	232085	49,50
Connettore IP68, 3 poli		
● nero	228730	23,00

OTOS GLAS Pole, E27

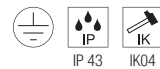
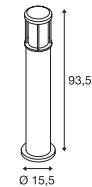

220-240V ~50/60Hz
Materiale: alluminio/vetro

- Ancoraggi per cemento inclusi



Attacco: 1xE27 Ø max.: 6,5 cm L: 14,5 cm

Versione	Articolo	EUR
● antracite	230465	144,00



A60 | 7,5W | 320°
2700K | 800lm | Classe=F
8kWh/1000h



Articolo: 1005303 | 9,60 EUR



Articolo	Articolo	EUR
Set di viti		
● acciaio inox	228753	9,25
Connettore IP68, 3 poli		
● nero	228730	23,00

CUBIX
FL, QPAR51

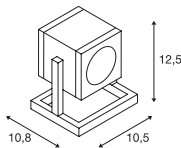

220-240V ~50/60Hz
Materiale: alluminio/vetro

- Spina Schuko IP44



Attacco: 1xGU10

Versione	Articolo	EUR
● antracite	132835	127,00

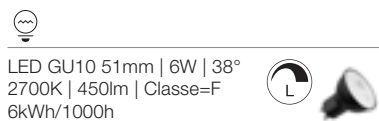

Articolo: 1005077 | 7,50 EUR

CONE
FL, E27

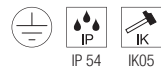
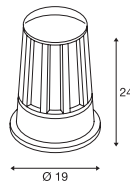

220-240V ~50/60Hz
Materiale: alluminio/vetro



Attacco: 1xE27 max. L: 15 cm

Versione	Articolo	EUR
● antracite	230435	100,00

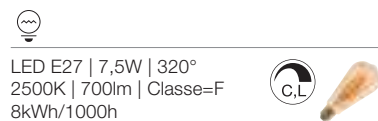

Articolo: 1005265 | 26,50 EUR



132835 660



230435 660



1000821 661

MOLAT
PD, E27

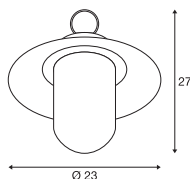

220-240V ~50/60Hz
Materiale: alluminio/vetro

- Catena per sospensione inclusa
- Spina Schuko IP44



Attacco: 1xE27 Ø max.: 6,5 cm L: 14,5 cm

Versione	Articolo	EUR
● antracite	1000821	147,00



LED E27 | 7,5W | 320°
2700K | 800lm | Classe=F
8kWh/1000h



Articolo: 1005268 | 12,25 EUR



Articolo	Articolo	EUR
Rosone		
● antracite	1000398	80,00

MOLAT
Pole, E27

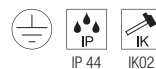
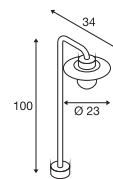

220-240V ~50/60Hz
Materiale: alluminio/vetro



Attacco: 1xE27 Ø max.: 6,5 cm L: 14,5 cm

Versione	Articolo	EUR
● antracite	1000822	181,00



LED E27 | 7,5W | 320°
2500K | 700lm | Classe=F
8kWh/1000h



Articolo: 1005265 | 26,50 EUR



Articolo	Articolo	EUR
Picchetto		
● grigio	230060	53,00



1000822 661

LISENNE 40
Pole, E27

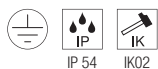
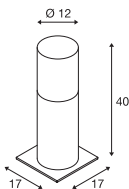

220-240V ~50/60Hz
Materiale: basalto/vetro



Attacco: 1xE27 Ø max.: 5,9 cm L: 15 cm

Versione	Articolo	EUR
● grigio	1000665	400,00



LED E27 | 7,5W | 320°
2700K | 800lm | Classe=F
8kWh/1000h



Articolo: 1005268 | 12,25 EUR



Articolo	Articolo	EUR
Picchetto		
● grigio	229422	45,50

LISENNE 70
Pole, E27

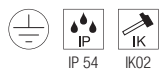
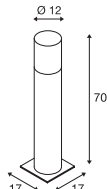

220-240V ~50/60Hz
Materiale: basalto/vetro



Attacco: 1xE27 Ø max.: 5,9 cm L: 15 cm

Versione	Articolo	EUR
● grigio	1000666	458,00



LED E27 | 7,5W | 320°
2700K | 800lm | Classe=F
8kWh/1000h



Articolo: 1005268 | 12,25 EUR



Articolo	Articolo	EUR
Picchetto		
● grigio	229422	45,50

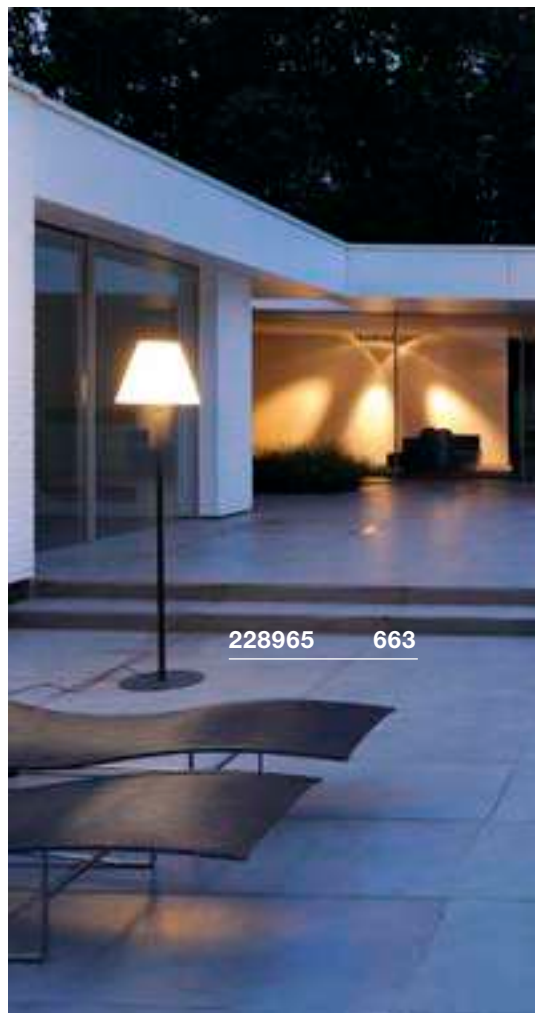

228965 663



ADEGAN MANILA
FL, E27

ADEGAN
FL, E27

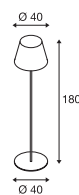
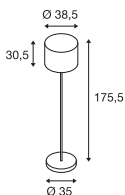

220-240V ~50/60Hz
Materiale: granito/acciaio inox

- Spina Schuko IP44

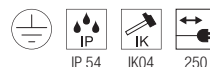

220-240V ~50/60Hz
Materiale: alluminio/polycarbonato (PC)

- Spina Schuko IP44



Attacco: 1xE27 Ø max.: 4,8 cm L: 18 cm

Versione	Articolo	EUR
● acciaio inox/antracite	1002494	393,00



LED E27 | 8W | 240°
3000K | 880lm | Classe=E
8kWh/1000h

Articolo: 1005289 | 10,25 EUR



Attacco: 1xE27 Ø max.: 5,2 cm

Versione	Articolo	EUR
● antracite	228965	303,00



LED E27 | 8W | 240°
3000K | 880lm | Classe=E
8kWh/1000h

Articolo: 1005289 | 10,25 EUR



Articolo	Articolo	EUR
Picchetto		
● antracite	228960	36,00





ALPA MUSHROOM 45

Pole, E27

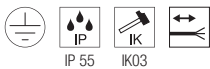
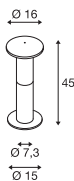

220-240V ~50/60Hz
Materiale: alluminio/policarbonato (PC)

- Cavo con terminale aperto



Attacco: 1xE27 Ø max.: 5,2 cm L: 16 cm

Versione	Articolo	EUR
● antracite	228935	131,00



LED E27 | 8W | 240°
3000K | 880lm | Classe=E
8kWh/1000h



Articolo: 1005289 | 10,25 EUR



Articolo	Articolo	EUR
Ancoraggi per cemento		
● argento	228712	64,00
Picchetto		
● grigio	228722	58,00
Connettore IP68, 3 poli		
● nero	228730	23,00

ALPA MUSHROOM 75

Pole, E27

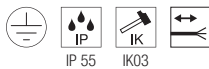
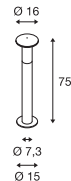

220-240V ~50/60Hz
Materiale: alluminio/policarbonato (PC)

- Cavo con terminale aperto



Attacco: 1xE27 Ø max.: 5,2 cm L: 16 cm

Versione	Articolo	EUR
● antracite	228945	161,00



LED E27 | 8W | 240°
3000K | 880lm | Classe=E
8kWh/1000h



Articolo: 1005289 | 10,25 EUR



Articolo	Articolo	EUR
Ancoraggi per cemento		
● argento	228712	64,00
Picchetto		
● grigio	228722	58,00
Connettore IP68, 3 poli		
● nero	228730	23,00

ALPA CONE 100

Pole, E27

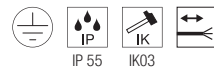
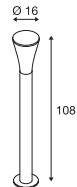

220-240V ~50/60Hz
Materiale: alluminio/policarbonato (PC)

- Cavo con terminale aperto



Attacco: 1xE27 Ø max.: 5,2 cm L: 17,5 cm

Versione	Articolo	EUR
● antracite	228925	191,00



LED E27 | 13,5W | 240°
3000K | 1520lm | Classe=E
14kWh/1000h



Articolo: 1005307 | 12,50 EUR



Articolo	Articolo	EUR
Ancoraggi per cemento		
● argento	228712	64,00
Picchetto		
● grigio	228722	58,00
Connettore IP68, 3 poli		
● nero	228730	23,00

APONI 90
Pole, PHASE

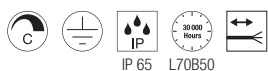
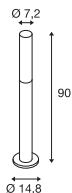

220-240V ~50/60Hz | 500mA
Potenza assorbita: 6,3W
Materiale: alluminio

- Cavo con terminale aperto



Down 520lm | 3000K

Versione	Articolo	EUR
● antracite	1000682	259,00



Articolo	Articolo	EUR
Connettore IP68, 3 poli		
● nero	228730	23,00

APONI 120
Pole, PHASE

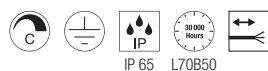
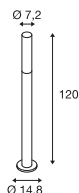

220-240V ~50/60Hz | 500mA
Potenza assorbita: 6,3W
Materiale: alluminio

- Cavo con terminale aperto



Down 520lm | 3000K

Versione	Articolo	EUR
● antracite	1000683	320,00



Articolo	Articolo	EUR
Connettore IP68, 3 poli		
● nero	228730	23,00





1000682 666

TRUST 30 Pole

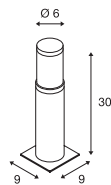

220-240V ~50/60Hz
Potenza assorbita: 9W
Materiale: acciaio inox 316



Down 400lm | 3000K

Versione	Articolo	EUR
● acciaio inox	228100	259,00



Articolo	Articolo	EUR
Picchetto		
● nero	227922	53,00
Reticolo ad anello		
● acciaio inox	228130	97,00
Connettore IP68, 3 poli		
● nero	228730	23,00

228110 667



TRUST 60 Pole

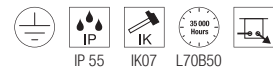
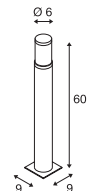

220-240V ~50/60Hz
Potenza assorbita: 9W
Materiale: acciaio inox 316



Down 400lm | 3000K

Versione	Articolo	EUR
● acciaio inox	228110	332,00



Articolo	Articolo	EUR
Picchetto		
● nero	227922	53,00
Reticolo ad anello		
● acciaio inox	228130	97,00
Connettore IP68, 3 poli		
● nero	228730	23,00

BIG NAILS 50
POLE, E27

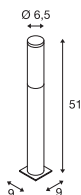

220-240V ~50/60Hz
Materiale: acciaio inox 304/
policarbonato (PC)



Attacco: 1xE27 Ø max.: 4,5 cm L: 17 cm

Versione	Articolo	EUR
● acciaio inox	229162	162,00



LED E27 | 8W | 240°
3000K | 880lm | Classe=E
8kWh/1000h



Articolo: **1005289** | **10,25 EUR**



Articolo	Articolo	EUR
Picchetto		
● nero	227922	53,00

BIG NAILS 80
POLE, E27

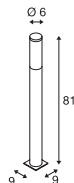

220-240V ~50/60Hz
Materiale: acciaio inox 304/
policarbonato (PC)



Attacco: 1xE27 Ø max.: 4,5 cm L: 17 cm

Versione	Articolo	EUR
● acciaio inox	229172	186,00



| 13,5W | 240°
3000K | 1520lm | Classe=E
14kWh/1000h



Articolo: **1005307** | **12,50 EUR**



Articolo	Articolo	EUR
Picchetto		
● nero	227922	53,00



229162 **668**



229172 **668**



1001490 **669**



ROX ACRYL 30

Pole, E27

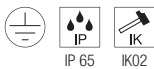
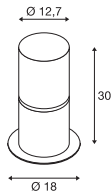

220-240V ~50/60Hz
Materiale: acciaio inox 304



Attacco: 1xE27 Ø max.: 6 cm L: 15 cm

Versione	Articolo	EUR
● acciaio inox	1001488	161,00



LED E27 | 8W | 240°
3000K | 880lm | Classe=E
8kWh/1000h



Articolo: **1005289** | **10,25 EUR**



Articolo	Articolo	EUR
Ancoraggi per cemento		
● acciaio inox	1001494	29,50
Picchetto		
● grigio	231234	52,00
Connettore IP68 a T, 3 poli		
● nero	228726	36,00

ROX ACRYL 60

Pole, E27

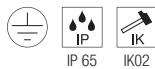
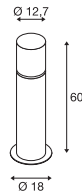

220-240V ~50/60Hz
Materiale: acciaio inox 304



Attacco: 1xE27 Ø max.: 6 cm L: 15 cm

Versione	Articolo	EUR
● acciaio inox	1001489	191,00



LED E27 | 8W | 240°
3000K | 880lm | Classe=E
8kWh/1000h



Articolo: **1005289** | **10,25 EUR**



Articolo	Articolo	EUR
Ancoraggi per cemento		
● acciaio inox	1001494	29,50
Picchetto		
● grigio	231234	52,00
Connettore IP68 a T, 3 poli		
● nero	228726	36,00

ROX ACRYL 90

Pole, E27

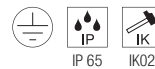
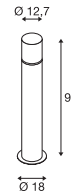

220-240V ~50/60Hz
Materiale: acciaio inox 304



Attacco: 1xE27 Ø max.: 6 cm L: 15 cm

Versione	Articolo	EUR
● acciaio inox	1001490	211,00



| 13,5W | 240°
3000K | 1520lm | Classe=E
14kWh/1000h



Articolo: **1005307** | **12,50 EUR**



Articolo	Articolo	EUR
Ancoraggi per cemento		
● acciaio inox	1001494	29,50
Picchetto		
● grigio	231234	52,00
Connettore IP68 a T, 3 poli		
● nero	228726	36,00



230066 671



23006 671



VAP SLIM 30

Pole, E27

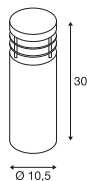

220-240V ~50/60Hz
Materiale: acciaio inox 304



Attacco: 1xE27 max. Ø: 5,1 cm | L: 12,6 cm

Versione	Articolo	EUR
● acciaio inox	230063	171,00



LED E27 | 8W | 240°
3000K | 880lm | Classe=E
8kWh/1000h



Articolo: **1005289** | **10,25 EUR**



Articolo	Articolo	EUR
Ancoraggi per cemento		
● acciaio inox	230061	26,25
Picchetto		
● grigio	230060	53,00

VAP SLIM 60

Pole, E27

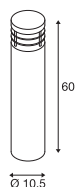

220-240V ~50/60Hz
Materiale: acciaio inox 304



Attacco: 1xE27 max. Ø: 5,1 cm | L: 12,6 cm

Versione	Articolo	EUR
● acciaio inox	230066	191,00



LED E27 | 8W | 240°
4000K | 920lm | Classe=E
8kWh/1000h



Articolo: **1005290** | **10,25 EUR**



Articolo	Articolo	EUR
Ancoraggi per cemento		
● acciaio inox	230061	26,25
Picchetto		
● grigio	230060	53,00

VAP SLIM 90

Pole, E27

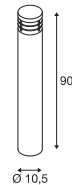

220-240V ~50/60Hz
Materiale: acciaio inox 304



Attacco: 1xE27 max. Ø: 5,1 cm | L: 12,6 cm

Versione	Articolo	EUR
● acciaio inox	230069	222,00



LED E27 | 8W | 240°
3000K | 880lm | Classe=E
8kWh/1000h



Articolo: **1005289** | **10,25 EUR**



Articolo	Articolo	EUR
Ancoraggi per cemento		
● acciaio inox	230061	26,25
Picchetto		
● grigio	230060	53,00

C-POL
POLE, E27

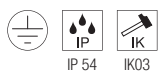
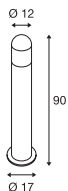

220-240V ~50/60Hz
Materiale: alluminio/policarbonato (PC)



Attacco: 1xE27 Ø max.: 5,2 cm L: 17,3 cm

Versione	Articolo	EUR
● antracite	231475	201,00

| 13,5W | 240°
 3000K | 1520lm | Classe=E
 14kWh/1000h

Articolo: 1005307 | 12,50 EUR

Articolo	Articolo	EUR
● nero	228730	23,00

F-POL
POLE, E27

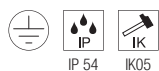
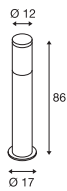

220-240V ~50/60Hz
Materiale: alluminio/policarbonato (PC)



Attacco: 1xE27 max. Ø: 5,1 cm L: 14,8 cm

Versione	Articolo	EUR
● antracite	231595	191,00

| LED E27 | 8W | 240°
 3000K | 880lm | Classe=E
 8kWh/1000h

Articolo: 1005289 | 10,25 EUR

Articolo	Articolo	EUR
● nero	228730	23,00

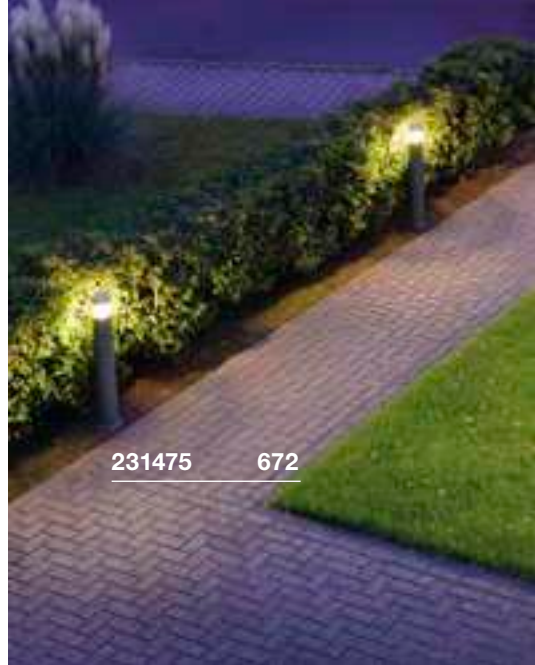

231475 672



231595 672

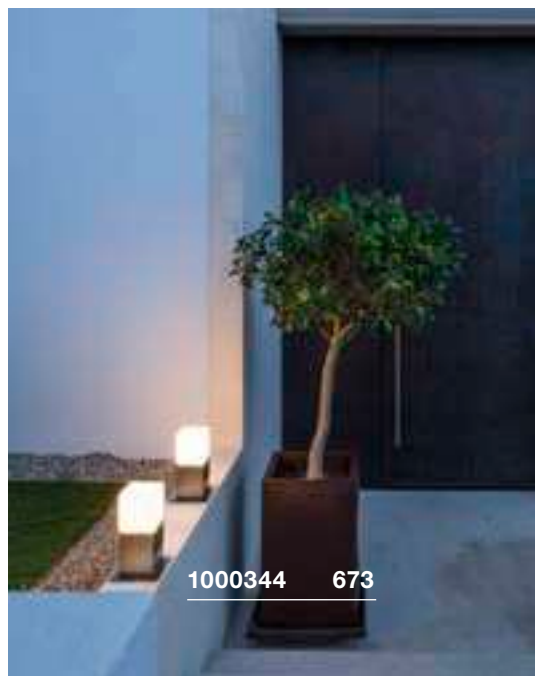

1000344 673



SQUARE POLE 30

Pole, E27

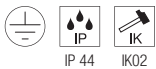
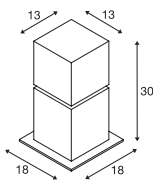

220-240V ~50/60Hz
Materiale: acciaio inox 304



Attacco: 1xE27 Ø max.: 6 cm L: 15 cm

Versione	Articolo	EUR
● acciaio inox	1000344	232,00



LED E27 | 8W | 240°
3000K | 880lm | Classe=E
8kWh/1000h



Articolo: **1005289** | **10,25 EUR**



Articolo	Articolo	EUR
Ancoraggi per cemento		
● acciaio inox	1000343	54,00
Picchetto		
● grigio	231234	52,00
Connettore IP68, 3 poli		
● nero	228730	23,00

SQUARE POLE 60

Pole, E27

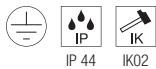
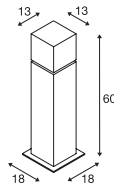

220-240V ~50/60Hz
Materiale: acciaio inox 304



Attacco: 1xE27 Ø max.: 6 cm L: 15 cm

Versione	Articolo	EUR
● acciaio inox	1000345	292,00



| 13,5W | 240°
3000K | 1520lm | Classe=E
14kWh/1000h



Articolo: **1005307** | **12,50 EUR**



Articolo	Articolo	EUR
Ancoraggi per cemento		
● acciaio inox	1000343	54,00
Picchetto		
● grigio	231234	52,00
Connettore IP68, 3 poli		
● nero	228730	23,00

SQUARE POLE 90

Pole, E27

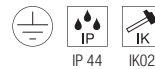
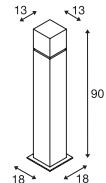

220-240V ~50/60Hz
Materiale: acciaio inox 304



Attacco: 1xE27 Ø max.: 6 cm L: 15 cm

Versione	Articolo	EUR
● acciaio inox	1000346	343,00



| 13,5W | 240°
3000K | 1520lm | Classe=E
14kWh/1000h



Articolo: **1005307** | **12,50 EUR**



Articolo	Articolo	EUR
Ancoraggi per cemento		
● acciaio inox	1000343	54,00
Picchetto		
● grigio	231234	52,00
Connettore IP68, 3 poli		
● nero	228730	23,00



231455 675



SLOTS 45 Pole

SLOTS 65 Pole

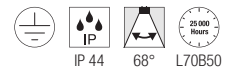
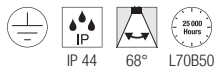
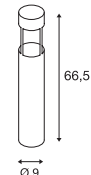
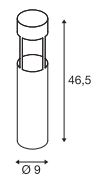

220-240V ~50/60Hz
Potenza assorbita: 4,5W
Materiale: alluminio

220-240V ~50/60Hz
Potenza assorbita: 4,5W
Materiale: alluminio

- Ancoraggi per cemento inclusi

- Ancoraggi per cemento inclusi



Down 200lm | 3000K

Down 200lm | 3000K

Versione	Articolo	EUR
● antracite	231815	181,00
● ruggine	231817	181,00

Versione	Articolo	EUR
● antracite	231455	191,00
● ruggine	231457	191,00

H-POL 30 Pole

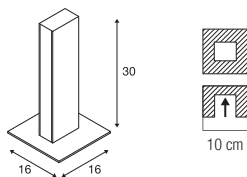

100-277V ~50/60Hz | 480mA
Potenza assorbita: 9,7W
Materiale: alluminio/plastica

- L'installazione del prodotto prevede l'incasso a pavimento (scarica il foglio istruzioni su slv.com)
- Per la posa nel terreno è disponibile una cassaforma opzionale più grande con dimensioni di incasso
L: 14 cm La: 14 cm P: 16 cm



Down 350lm | 3000K

Versione	Articolo	EUR
● antracite	232155	242,00



Articolo	Articolo	EUR
Cassaforma 14x14 cm		
● nero	232195	49,50

H-POL 60 Pole

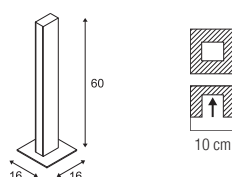

100-277V ~50/60Hz | 500mA
Potenza assorbita: 18W
Materiale: alluminio/plastica

- L'installazione del prodotto prevede l'incasso a pavimento (scarica il foglio istruzioni su slv.com)
- Per la posa nel terreno è disponibile una cassaforma opzionale più grande con dimensioni di incasso
L: 14 cm La: 14 cm P: 16 cm



Down 700lm | 3000K

Versione	Articolo	EUR
● antracite	232165	353,00



Articolo	Articolo	EUR
Cassaforma 14x14 cm		
● nero	232195	49,50

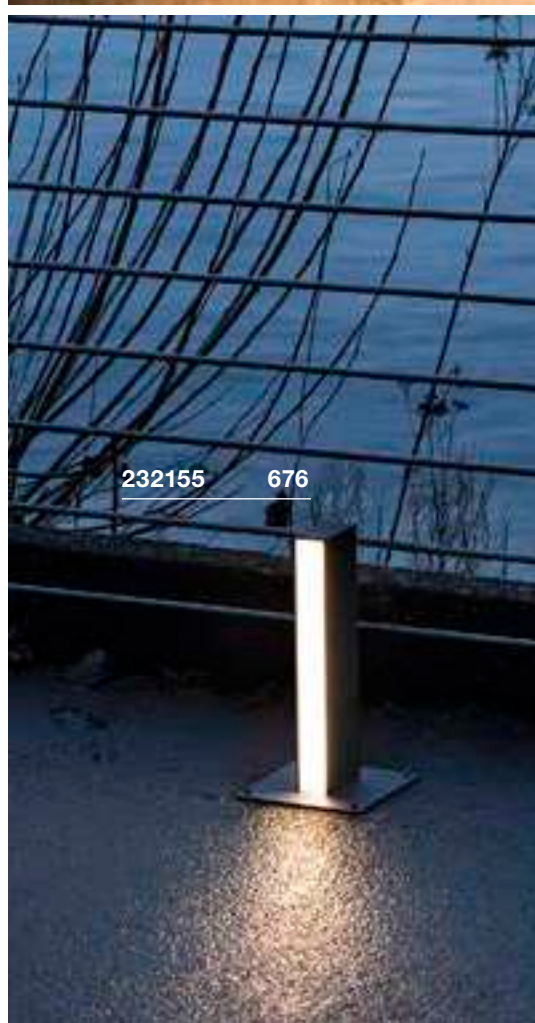

232155

676

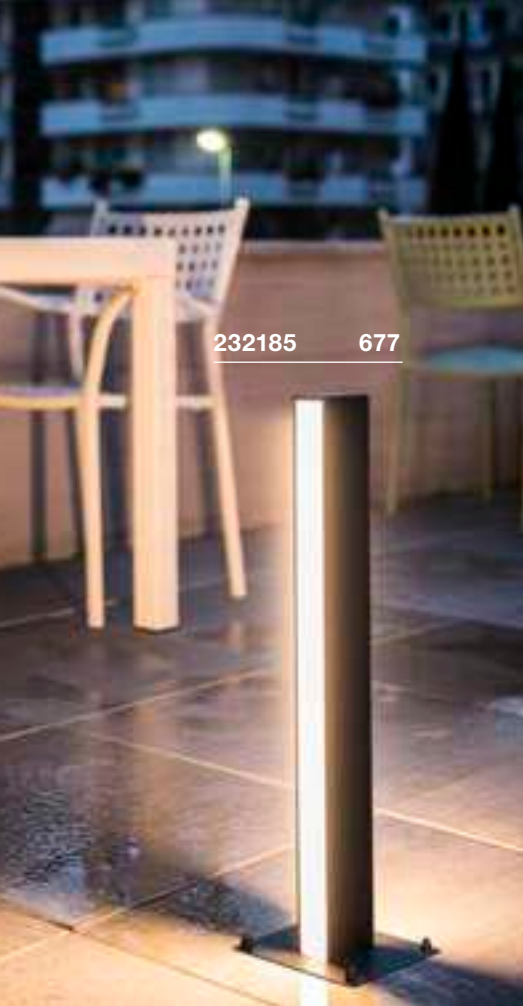

232185 677

H-POL TWIN 30 Pole

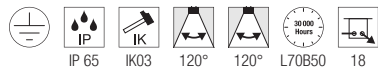
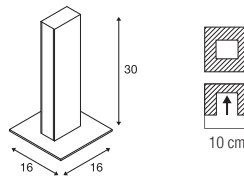

100-277V ~50/60Hz | 500mA
 Potenza assorbita: 18W
 Materiale: alluminio/plastica

- L'installazione del prodotto prevede l'incasso a pavimento (scarica il foglio istruzioni su slv.com)
- Per la posa nel terreno è disponibile una cassaforma opzionale più grande con dimensioni di incasso
 L: 14 cm La: 14 cm P: 16 cm



Down 350lm | 3000K

Versione	Articolo	EUR
● antracite	232175	333,00



Articolo	Articolo	EUR
Cassaforma 14x14 cm		
● nero	232195	49,50

H-POL TWIN 60 Pole

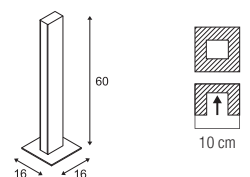

220-240V ~50/60Hz | 1000mA
 Potenza assorbita: 35W
 Materiale: alluminio/plastica

- L'installazione del prodotto prevede l'incasso a pavimento (scarica il foglio istruzioni su slv.com)
- Per la posa nel terreno è disponibile una cassaforma opzionale più grande con dimensioni di incasso
 L: 14 cm La: 14 cm P: 16 cm



Down 700lm | 3000K

Versione	Articolo	EUR
● antracite	232185	464,00



Articolo	Articolo	EUR
Cassaforma 14x14 cm		
● nero	232195	49,50



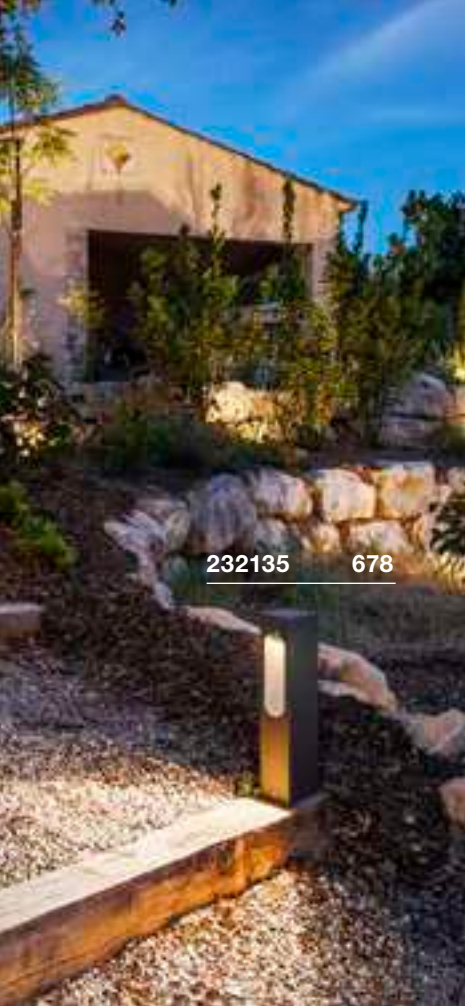

232135 678



232145 678

SLOTBOX 40 Pole

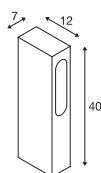

100-277V ~50/60Hz | 700mA
Potenza assorbita: 8W
Materiale: alluminio

- Cavo con terminale aperto



Down 160lm | 3000K

Versione	Articolo	EUR
● antracite	232135	201,00



Articolo	Articolo	EUR
● nero	228730	23,00

Connettore IP68, 3 poli

SLOTBOX 70 Pole

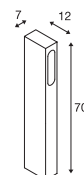

100-277V ~50/60Hz | 700mA
Potenza assorbita: 8,7W
Materiale: alluminio

- Cavo con terminale aperto



Down 160lm | 3000K

Versione	Articolo	EUR
● antracite	232145	242,00



Articolo	Articolo	EUR
● nero	228730	23,00

Connettore IP68, 3 poli



1002957 679



1002958 679

FLATT 65 POLE

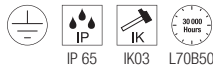
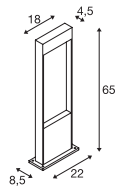
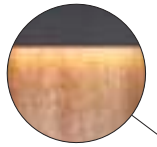

100-240V ~50/60Hz | 350mA
Potenza assorbita: 10W
Materiale: alluminio/alluminio

- Temperatura del colore selezionabile prima dell'installazione tramite il selettore posizionato all'interno dell'alloggiamento



Down 400lm | 3000K | 400lm | 4000K

Versione	Articolo	EUR
● antracite	1002956	248,00
●● marrone/antracite	1002957	248,00



Articolo	Articolo	EUR
Connettore IP68, 3 poli		
● nero	228730	23,00

FLATT 100 POLE

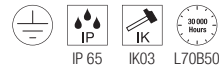
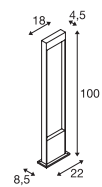

100-240V ~50/60Hz | 350mA
Potenza assorbita: 10W
Materiale: alluminio/alluminio

- Temperatura del colore selezionabile prima dell'installazione tramite il selettore posizionato all'interno dell'alloggiamento



Down 400lm | 3000K | 400lm | 4000K

Versione	Articolo	EUR
● antracite	1002958	302,00
●● marrone/antracite	1002959	302,00



Articolo	Articolo	EUR
Connettore IP68, 3 poli		
● nero	228730	23,00



1002991 681



1002992 681

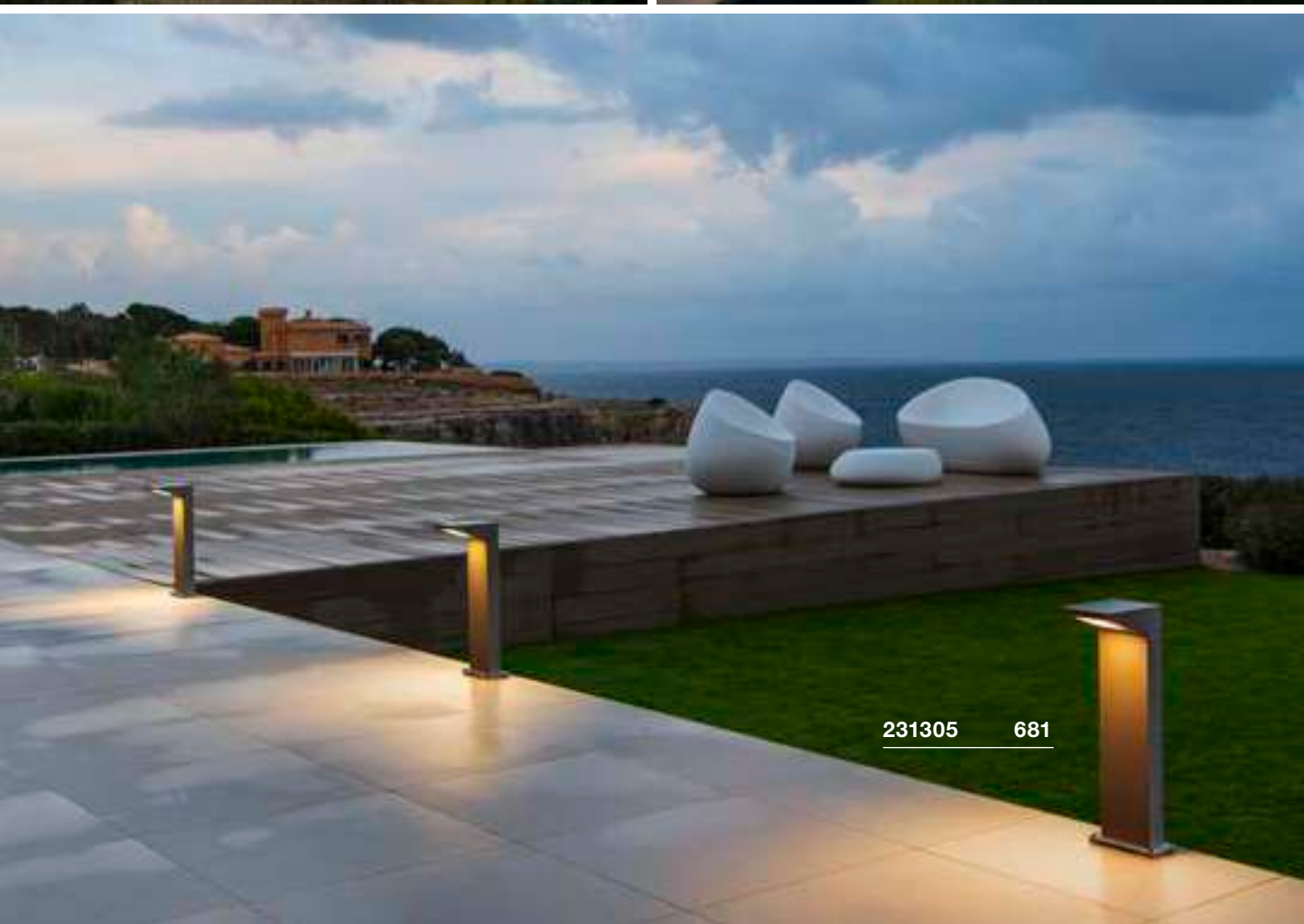

231305 681



ABRIDOR 60 Pole

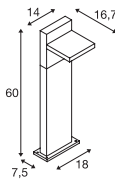

100-240V ~50/60Hz | 300mA
Potenza assorbita: 12W
Materiale: alluminio



Down 950lm | 3000K | 980lm | 4000K

Versione	Articolo	EUR
● antracite	1002991	222,00

ABRIDOR 100 Pole

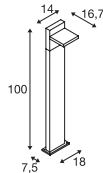

100-240V ~50/60Hz | 300mA
Potenza assorbita: 12W
Materiale: alluminio



Down 950lm | 3000K | 980lm | 4000K

Versione	Articolo	EUR
● antracite	1002992	282,00

IPERI 50 Pole

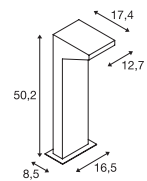

220-240V ~50/60Hz
Potenza assorbita: 4,5W
Materiale: alluminio/plastica



Down 400lm | 4000K

Versione	Articolo	EUR
● antracite	231305	129,00



Articolo	Articolo	EUR
Picchetto		
● grigio	231231	49,50

QUADRASYL 75

Pole, TCR-TSE

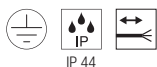
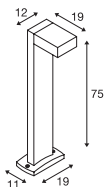

220-240V ~50/60Hz
Materiale: alluminio

- Ancoraggi per cemento inclusi
- Cavo con terminale aperto



Attacco: 1xGX53 Ø max.: 7,5 cm L: 2,7 cm

Versione	Articolo	EUR
● antracite	232295	166,00
● grigio	232294	166,00



LED GX53 | 6,1W | 120°
3000K | 490lm | Classe=G
6kWh/1000h



Articolo: 1005271 | 11,50 EUR



Articolo	Articolo	EUR
Connettore IP68 a T, 3 poli		
● nero	228726	36,00

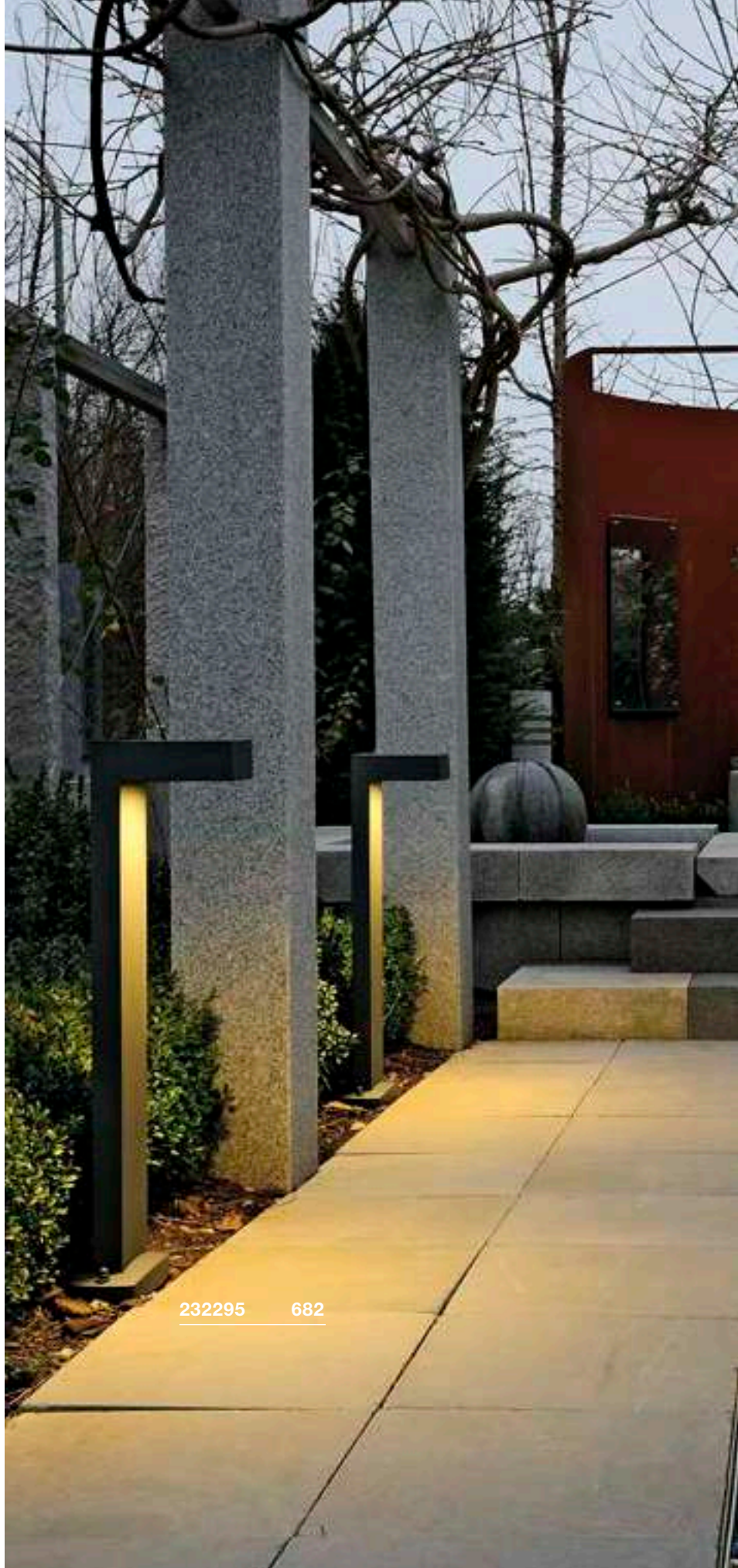

232295 682



1003001 683

QUAD POLE Pole

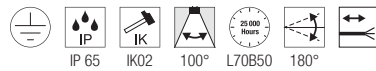
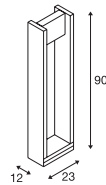

100-277V ~50/60Hz | 500mA
Potenza assorbita: 18W
Materiale: alluminio/vetro

- Cavo con terminale aperto



Down 1550lm | 3000K

Versione	Articolo	EUR
● antracite	1003001	370,00

BOOKAT Pole

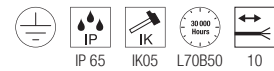
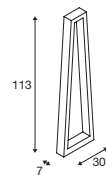

100-277V ~50/60Hz | 700mA
Potenza assorbita: 15W
Materiale: alluminio/policarbonato (PC)

- Connettore IP68 incluso



Down 1240lm | 3000K | 1300lm | 4000K

Versione	Articolo	EUR
● antracite	1005441	403,00

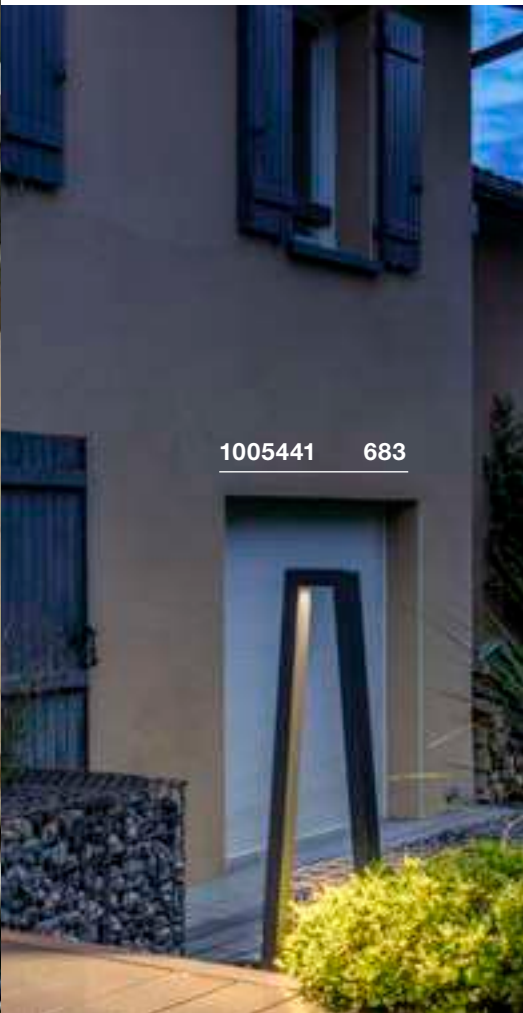

1005441 683



Articolo	Articolo	EUR
● nero	228730	23,00

Connettore IP68 a T, 3 poli

RASCALI 45
Pole

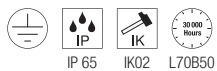
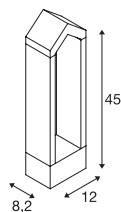

220-240V ~50/60Hz
Potenza assorbita: 8W
Materiale: alluminio



Down 360lm | 3000K

Versione	Articolo	EUR
● antracite	1000799	184,00

RASCALI 65
Pole

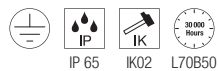
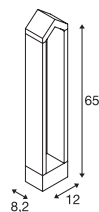

220-240V ~50/60Hz
Potenza assorbita: 8W
Materiale: alluminio



Down 360lm | 3000K

Versione	Articolo	EUR
● antracite	1000801	207,00



1000799 684



1000801 684

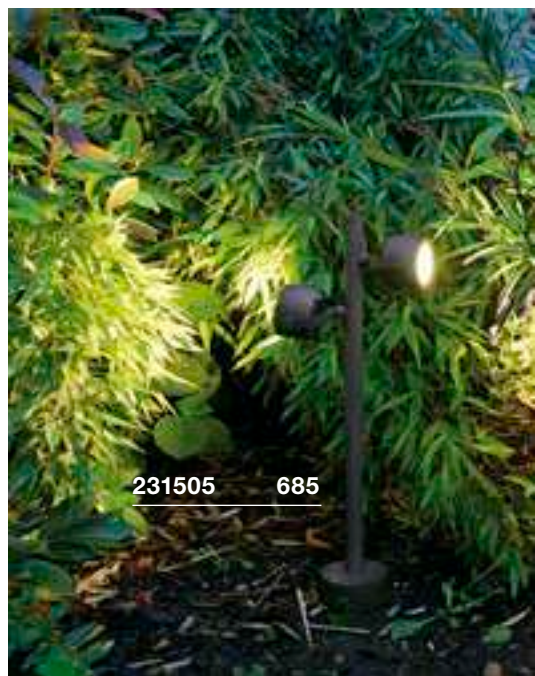

231505 685



MYRA SPOT
Double, GU10

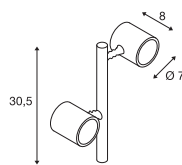

220-240V ~50/60Hz
Materiale: alluminio

- È possibile aumentare l'altezza installando max 2 aste di prolunga da 30 cm cad.
- Cavo con terminale aperto

SOCKET INSIDE <4.5 W

Attacco: 2xGU10 max. Ø: 5,1 cm | L: 5,7 cm

Versione	Articolo	EUR
● antracite	233185	169,00



LED GU10 51mm | 6W | 38°
2700K | 450lm | Classe=F
6kWh/1000h



Articolo: 1005075 | 7,50 EUR



Articolo	Articolo	EUR
Ancoraggi per cemento		
● argento	228712	64,00
Set di viti		
● acciaio inox	228752	6,50
Piede di appoggio rotondo		
● antracite	233145	26,75
Asta di prolunga 30 cm		
● antracite	233165	26,75

SITRA 360
Pole, TCR-TSE

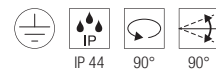
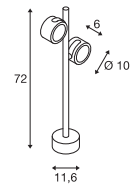

220-240V ~50/60Hz
Materiale: alluminio/vetro

SOCKET INSIDE <9 W

Attacco: 2xGX53 Ø max.: 7,5 cm | L: 3,5 cm

Versione	Articolo	EUR
● antracite	231505	162,00



LED GX53 | 6,1W | 120°
3000K | 490lm | Classe=G
6kWh/1000h



Articolo: 1005271 | 11,50 EUR



Articolo	Articolo	EUR
Picchetto		
● grigio	230060	53,00





1001962 697



LED
SYNA PLANT | 689



LED
SYNA GARDEN | 689



LED
SYNA | 689



LED
FLOODI S | 691



LED
FLOODI M | 691



LED
FLOODI L | 691



LED
GALEN 60 | 692



LED
GALEN 120 | 692



LED
FLAC BEAM® | 693



S-CCKET
SAMRINA | 693



S-CCKET
NAUTILUS 10 | 694



S-CCKET
BIG NAUTILUS | 694



S-CCKET
NAUTILUS 10 | 695



LED
NAUTILUS 10 | 696



S-CCKET
NAUTILUS | 697



S-CCKET
NAUTILUS 10
SPOT | 697



LED
NAUTILUS 10
SPOT LED | 697



LED
DASAR®
PROJECTOR | 698



LED
DASAR® 920 | 698



LED
HELIA SPOT S | 699



LED
HELIA SPOT L | 699



S-CCKET
THEO BRACKET | 701



LED
LED SPIKE | 701



S-CCKET
SITRA 360 SPIKE | 703



S-CCKET
SITRA 360 SPIKE | 703





SYNA PLANT SP

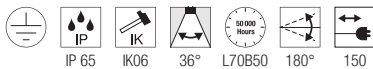
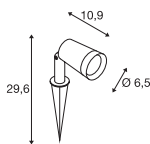

220-240V ~50/60Hz | 250mA
Potenza del sistema: 6W
Materiale: alluminio

- Spina Schuko IP44



Down 540lm | 3000K

Versione	Articolo	EUR
● nero	1007146 ●	65,00

SYNA GARDEN SP

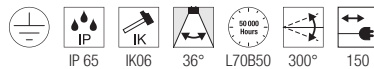
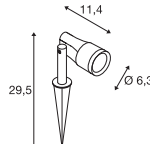

220-240V ~50/60Hz | 250mA
Potenza del sistema: 6W
Materiale: alluminio

- Spina Schuko IP44



Down 540lm | 3000K

Versione	Articolo	EUR
● nero	1007147 ●	69,00

SYNA SP

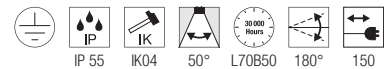
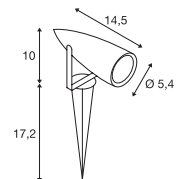

220-240V ~50/60Hz
Potenza del sistema: 9W
Materiale: alluminio/acrilico

- Spina Schuko IP44



Down 470lm | 3000K

Versione	Articolo	EUR
● antracite	227505	80,00



1006193 691



FLOODI S SP

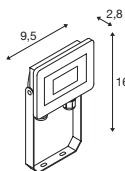

220-240V ~50/60Hz
Potenza del sistema: 9,3W
Materiale: alluminio



Down 1040lm | 3000K

Versione	Articolo	EUR
● antracite	1006191	30,00



Articolo	Articolo	EUR
Sensore di movimento		
● nero	1006326	29,00

FLOODI M SP

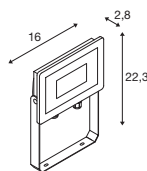

220-240V ~50/60Hz
Potenza del sistema: 30W
Materiale: alluminio



Down 2980lm | 3000K

Versione	Articolo	EUR
● antracite	1006192	45,00



Articolo	Articolo	EUR
Sensore di movimento		
● nero	1006326	29,00

FLOODI L SP

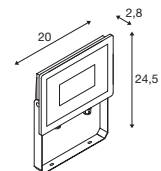

220-240V ~50/60Hz
Potenza del sistema: 48W
Materiale: alluminio



Down 5150lm | 3000K

Versione	Articolo	EUR
● antracite	1006193	60,00



Articolo	Articolo	EUR
Sensore di movimento		
● nero	1006326	29,00

GALEN 60 SP

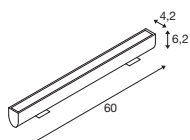

220-240V ~50/60Hz | 450mA
Potenza del sistema: 18W
Materiale: alluminio/vetro



Down 1570lm | 3000K | 1570lm | 4000K

Versione	Articolo	EUR
● antracite	1003447	229,00



Articolo	Articolo	EUR
Cavo di alimentazione 5m rete-lampada		
● nero	231960	28,00
Cavo di collegamento 1m lampada-lampada		
● nero	231961	19,00

GALEN 120 SP

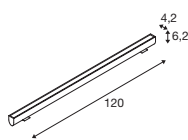

220-240V ~50/60Hz | 900mA
Potenza del sistema: 34W
Materiale: alluminio/vetro



Down 3000lm | 3000K | 3100lm | 4000K

Versione	Articolo	EUR
● antracite	1003448	339,00



Articolo	Articolo	EUR
Cavo di alimentazione 5m rete-lampada		
● nero	231960	28,00
Cavo di collegamento 1m lampada-lampada		
● nero	231961	19,00





FLAC BEAM® SP

SAMRINA SP, single, GU10



1003448 692

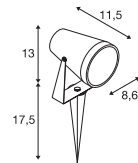
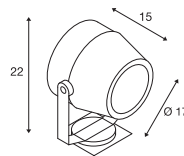

220-240V ~50/60Hz
Potenza del sistema: 27W
Materiale: alluminio/vetro

220-240V ~50/60Hz
Materiale: plastica/vetro

- Spina Schuko IP44

- Contiene materiale riciclato
- Spina Schuko IP44



Down 1600lm | 3000K



Attacco: GU10 Ø max: 6 cm | L: 6 cm

Versione	Articolo	EUR
● grigio	231072	492,00

Versione	Articolo	EUR
● nero	1004757	45,50



LED GU10 51mm | 6W | 38°
2700K | 450lm | Classe=F
6kWh/1000h



Articolo: 1005077 | 7,50 EUR



NAUTILUS 10
SP, rotondo, QPAR51

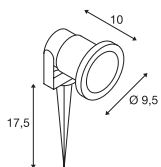

220-240V ~50/60Hz
Materiale: alluminio

- Spina Schuko IP44



Attacco: 1xGU10 L max: 8 cm

Versione	Articolo	EUR
● grigio	227418	27,00

LED GU10 51mm | 6W | 38°
 2700K | 450lm | Classe=F
 6kWh/1000h

Articolo: 1005077 | 7,50 EUR

BIG NAUTILUS
SP, rotondo, QPAR51

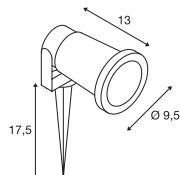

220-240V ~50/60Hz
Materiale: alluminio

- Spina Schuko IP44



Attacco: GU10 Ø max: 5,1 cm | L: 8,3 cm

Versione	Articolo	EUR
● nero	227410	30,00
● ruggine	1001964	30,00
● verde	1001965	30,00

LED GU10 51mm | 6W | 38°
 2700K | 450lm | Classe=F
 6kWh/1000h

Articolo: 1005077 | 7,50 EUR





NAUTILUS 10

SP, rotondo, QPAR51

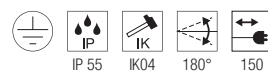
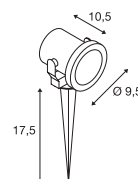

220-240V ~50/60Hz
Materiale: acciaio inox 316

- Spina Schuko IP44

SOCKET INSIDE  <25 W

Attacco: 1xGU10 Ø max: 5,1 cm L: 5,7 cm

Versione	Articolo	EUR
● acciaio inox	229740	99,00



LED GU10 51mm | 6W | 38°
2700K | 450lm | Classe=F
6kWh/1000h



Articolo: 1005077 | 7,50 EUR

1001964 694



231035 696

NAUTILUS 10 SP, quadrato

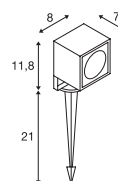

100-277V ~50/60Hz | 700mA
Potenza del sistema: 8,5W
Materiale: alluminio

- Spina Schuko IP44



1001962 697



Down

660lm | 3000K

Versione	Articolo	EUR
● antracite	231035	145,00



NAUTILUS SP, QR-C51

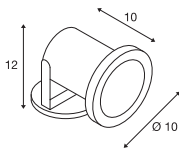

12V ~50Hz
Materiale: acciaio inox 304

- Cavo con estremità aperta

SOCKET
INSIDE <35 W

Attacco: 1xGX5.3

Versione	Articolo	EUR
● acciaio inox	229090	89,00



LED GU5.3 | 5,8W | 36°
2700K | 450lm | Classe=G
6kWh/1000h

Articolo: **1001574** | **35,00 EUR**

NAUTILUS 10 SPOT SP, QPAR51

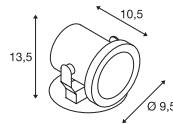

220-240V ~50/60Hz
Materiale: acciaio inox 316

- Cavo con estremità aperta

SOCKET
INSIDE <25 W

Attacco: 1xGU10 Ø max: 5,1 cm L: 6 cm

Versione	Articolo	EUR
● acciaio inox	229741	99,00



LED GU10 51mm | 6W | 38°
2700K | 450lm | Classe=F
6kWh/1000h

Articolo: **1005077** | **7,50 EUR**



Articolo	Articolo	EUR
Connettore IP68, 3 poli		
● nero	228730	23,00

NAUTILUS 10 SPOT LED SP

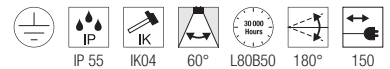
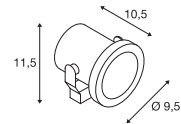

220-240V ~50/60Hz
Potenza del sistema: 9W
Materiale: acciaio inox 316

- Spina Schuko IP44

LED
INSIDE CRI 80

Down 520lm | 3000K

Versione	Articolo	EUR
● acciaio inox	1001962	114,00



Articolo	Articolo	EUR
Picchetto in plastica		
● nero	900011	4,00
Piastra di montaggio in acciaio inox		
● acciaio inox	1001963	9,05

DASAR® PROJECTOR
SP, 12/24V

DASAR® 920
SP, 230V

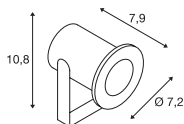
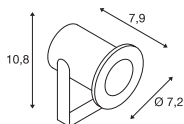

12-24V DC
Potenza del sistema: 6,5W
Materiale: acciaio inox 316

220-240V ~50/60Hz | 400mA
Potenza del sistema: 4,6W
Materiale: acciaio inox 316

- Cavo con estremità aperta

- Spina Schuko IP44



Down 520lm | 3000K

Versione	Articolo	EUR
● acciaio inox	233570	242,00



Articolo	Articolo	EUR
Picchetto acciaio inox		
● acciaio inox	233580	19,00
Picchetto in plastica		
● nero	900011	4,00
Alimentatore LED 15W 12V		
○ bianco	1005444	29,50
Alimentatore LED 15W 24V		
○ bianco	1005445	29,50
Piastra di montaggio in acciaio inox		
● acciaio inox	233582	26,00



Down 300lm | 3000K

Versione	Articolo	EUR
● acciaio inox	233571	302,00



Articolo	Articolo	EUR
Picchetto acciaio inox		
● acciaio inox	233580	19,00
Picchetto in plastica		
● nero	900011	4,00
Piastra di montaggio in acciaio inox		
● acciaio inox	233582	26,00

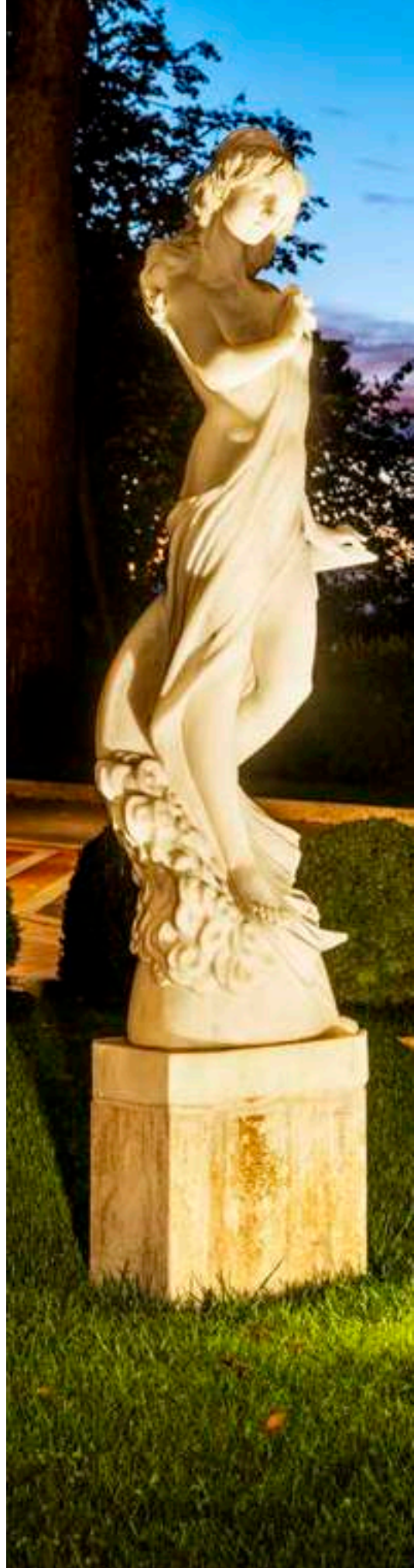



HELIA SPOT S SP, single

HELIA SPOT L SP, single, PHASE

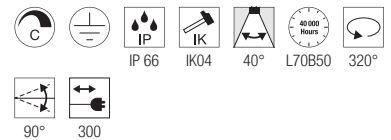
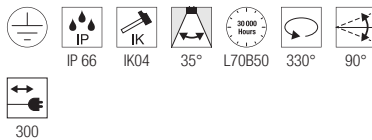
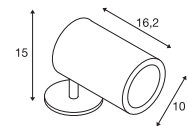
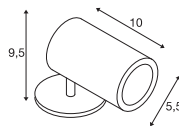

220-240V ~50/60Hz | 500mA
Potenza del sistema: 6,5W
Materiale: alluminio

220-240V ~50/60Hz | 700mA
Potenza del sistema: 15W
Materiale: alluminio

- Spina Schuko IP44

- Spina Schuko IP44



Down 440lm | 3000K

Down 1340lm | 3000K

Versione	Articolo	EUR
● antracite	1000735	176,00

Versione	Articolo	EUR
● antracite	228555	226,00



Articolo	Articolo	EUR
Picchetto acciaio inox		
● acciaio inox	1000736	21,75

Articolo	Articolo	EUR
Picchetto in acciaio inox		
● acciaio inox	228560	26,50



1004652 701

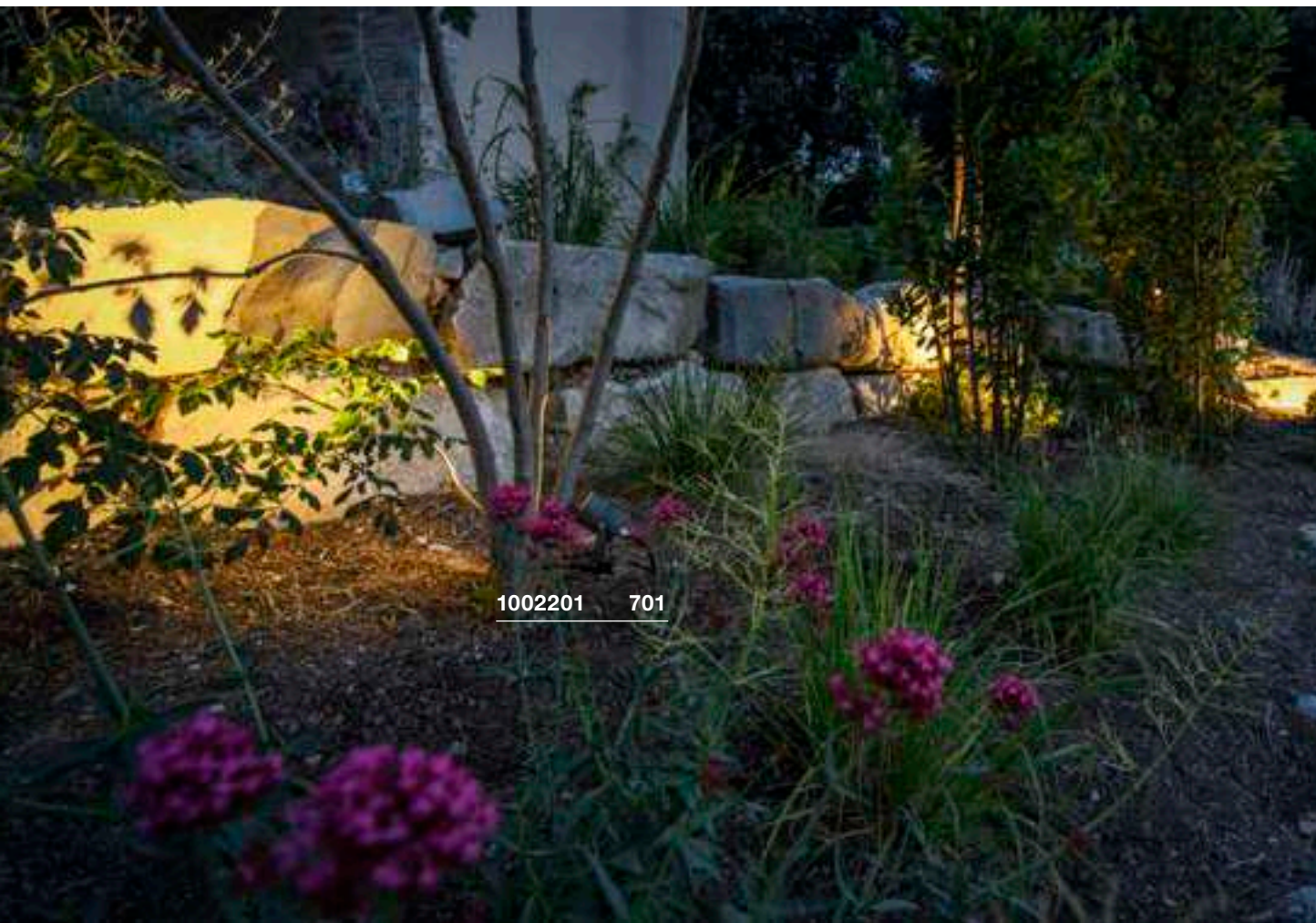

1002201 701



THEO BRACKET SP

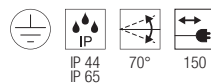
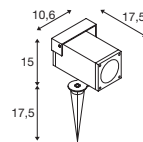

220-240V ~50/60Hz
Materiale: alluminio

- Spina Schuko IP44



Attacco: 1xGU10 Ø max: 5,1 cm L: 5,7 cm

Versione	Articolo	EUR
● antracite	1004652	66,00



LED GU10 51mm | 6W | 38°
2700K | 450lm | Classe=F
6kWh/1000h



Articolo: 1005077 | 7,50 EUR

LED SPIKE SP

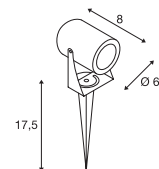

100-240V ~50/60Hz | 240mA
Potenza del sistema: 6W
Materiale: alluminio

- Spina Schuko IP44



Down 400lm | 3000K

Versione	Articolo	EUR
● antracite	1002201	70,00
● ruggine	1002203	70,00

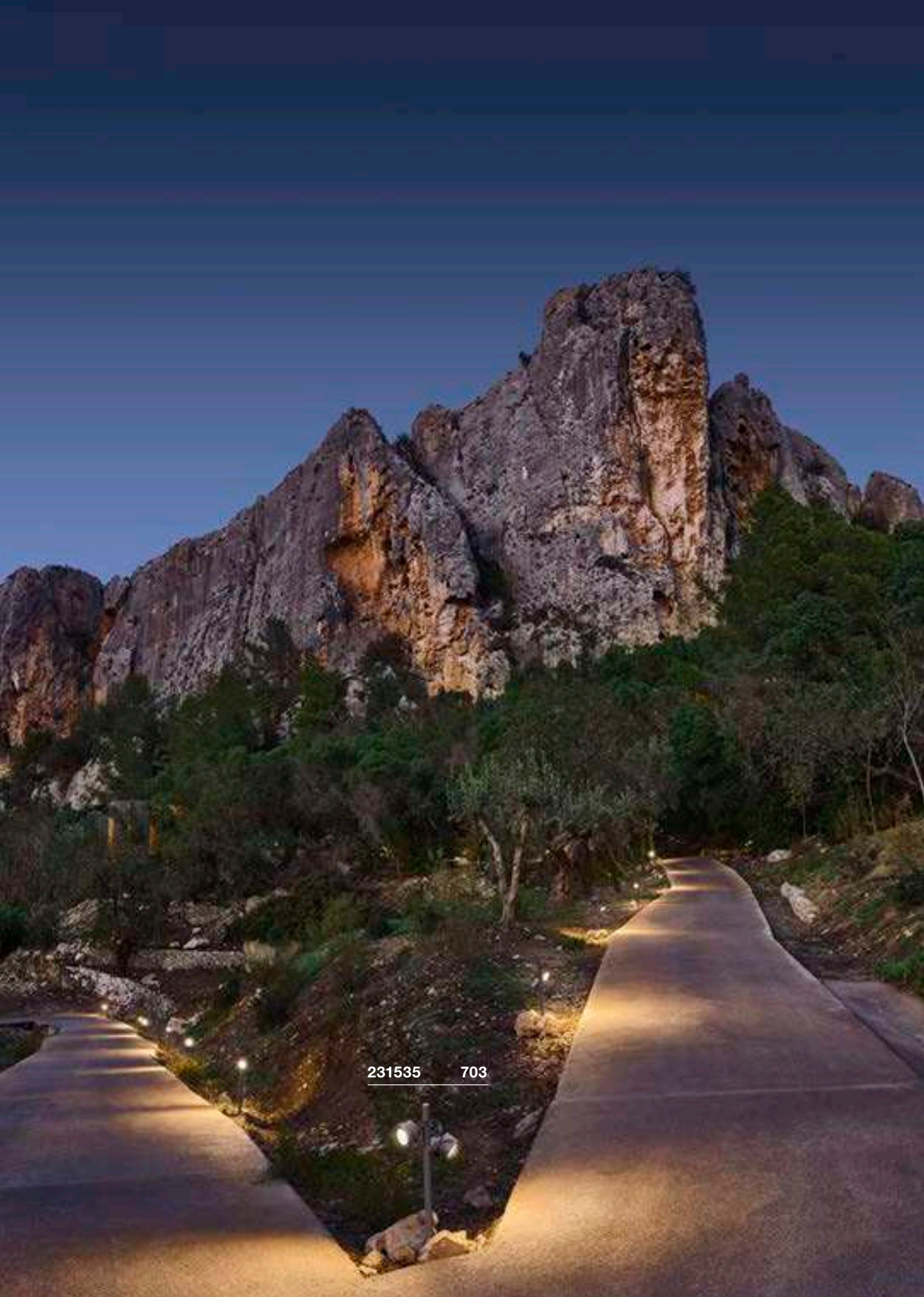

231535 703



SITRA 360 SPIKE
SP, single, TCR-TSE

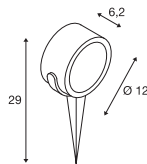

220-240V ~50/60Hz
Materiale: alluminio

- Spina Schuko IP44

SOCKET INSIDE <9 W

Attacco: 1xGX53 Ø max: 7,5 cm L: 3,5 cm

Versione	Articolo	EUR
● antracite	231525	64,00



LED GX53 | 6,1W | 120°
3000K | 490lm | Classe=G
6kWh/1000h



Articolo: 1005271 | 11,50 EUR

SITRA 360 SPIKE
SP, double, TCR-TSE

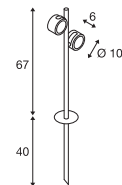

220-240V ~50/60Hz
Materiale: alluminio

- Spina Schuko IP44

SOCKET INSIDE <9 W

Attacco: 2xGX53 Ø max: 7,5 cm L: 3,5 cm

Versione	Articolo	EUR
● antracite	231535	191,00



LED GX53 | 6,1W | 120°
3000K | 490lm | Classe=G
6kWh/1000h



Articolo: 1005271 | 11,50 EUR



234515

735



SCKET
PHOTONI | 709

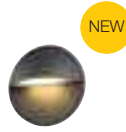

LED
LID II | 711

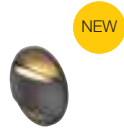

LED
LID II | 711

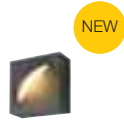

LED
LID I | 713



LED
LID I | 713

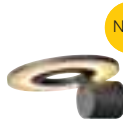

LED
I-RING | 714



LED
OVAL 14 | 715



LED
OVAL 18 | 715



LED
CONCRETO M | 717



LED
CONCRETO L | 717



LED
VANO WING | 719



LED
VANO WING | 719



LED
MANA BASE | 720



LED
RUSTY® MANA | 720



LED
RUSTY® MANA | 720



LED
MANA OUT | 721



LED
MANA OUT | 721



LED
ENOLA OCULUS | 723



LED
ENOLA
OCULUS | 723



LED
ENOLA
OCULUS S | 725



LED
ENOLA
OCULUS M | 725



LED
ENOLA
ROUND L | 725



LED
ENOLA ROUND S
UP/DOWN | 727



LED
ENOLA ROUND M
UP/DOWN | 727



LED
ENOLA ROUND L
UP/DOWN | 727



LED
ENOLA
SQUARE S | 729



LED
ENOLA
SQUARE M | 729



LED
ENOLA
SQUARE L | 729



LED
ENOLA SQUARE S
UP/DOWN | 730



LED
ENOLA SQUARE M
UP/DOWN | 730



LED
ENOLA SQUARE L
UP/DOWN | 730



SCKET
THEO UP/DOWN | 735



LED
BIG THEO BEAM UP/
FLOOD DOWN | 735



SCKET
BIG THEO
UP/DOWN | 735



LED
BIG THEO FLOOD
UP/DOWN | 736



SCKET
THEO | 736



SCKET
BIG THEO | 737



LED
BIG THEO | 737



LED
SITRA S | 739



LED
SITRA S | 739



LED
SITRA M | 741



LED
SITRA L | 741

NEW



SCKET
SITRA CUBE | 741



SCKET
GRAFIT | 742



SCKET
GRAFIT | 742



SCKET
GRAFIT | 743



SCKET
GRAFIT | 743



LED
QUADRULO | 744



SCKET
QUADRULO
SENSOR | 745



SCKET
QUADRULO | 745



SCKET
MERIDIAN | 746



SCKET
MERIDIAN BOX | 746



SCKET
MERIDIAN BOX
SENSOR | 747



SCKET
MERIDIAN BOX | 747



LED
ESKINA FRAME | 749



LED
ESKINA FRAME | 749



LED
ESKINA FRAME | 749



LED
BOOKAT | 751



LED
BIG QUAD | 752



LED
QUAD | 752



LED
QUAD
UP/DOWN 15 | 753



LED
BIG QUAD
UP/DOWN | 755



LED
BIG QUAD | 755



LED
RUSTY®
UP/DOWN | 756



LED
RUSTY®
UP/DOWN | 756



LED
OVALISK
SENSOR | 757



LED
OVALISK | 757



LED
PEMA® | 758



LED
PEMA® | 759



LED
PEMA® | 759



SCKET
PEMA® | 759



LED
FLATT SENSOR | 760



LED
FLATT | 760



SCKET
ASTINA | 761



SCKET
ASTINA STEEL | 761



LED
ANGOLUX
SENSOR | 762



LED
ANGOLUX | 762



LED
VILUA S | 763



LED
VILUA L | 763



LED
VILUA | 763



SCKET
MYRA
UP/DOWN | 764



LED
SITRA
UP/DOWN | 765



SCKET
SITRA
UP/DOWN | 765



SCKET
ROX | 767



SCKET
ROX UP/DOWN | 767



LED
DELWA | 767



LED
SLOTS | 768



SCKET
WALLYX | 768



LED
DOWNUNDER
OUT | 769



LED
DOWNUNDER
OUT | 769



LED
ABRIDOR
SENSOR | 770



LED
ABRIDOR | 770



LED
ORDI SENSOR | 771



LED
ORDI | 771



SCKET
BOX-L | 773



LED
BOX-L | 773



SCKET
BOX UP/DOWN | 775



LED
LOGS | 775



LED
OUT-BEAM UP /
FLOOD DOWN | 775



LED
L-LINE OUT | 775



SCKET
PHOTONIA | 777



SCKET
MOLAT | 777



SCKET
GLOO PURE | 777



SCKET
F-POL | 778



SCKET
SQUARE | 779



SCKET
KERAS ELT | 779



SCKET
SITRA | 779



LED
RASCALI | 780



LED
IPERI | 780



SCKET
QUADRASYL | 781



SCKET
SQUARE TURN | 781



LED
TODAY PRO | 783



LED
ESKINA D | 783



SCKET
MYRA DISPLAY | 783



LED
LED SPOT | 785



SCKET
NAUTILUS | 785



SCKET
MYRA | 785

1007585 709





PHOTONI WL, E27

NEW

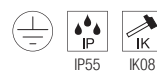
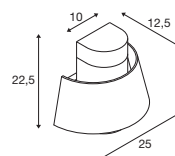

220-240V ~50/60Hz
Materiale: alluminio

- Resistente all'aria marina

SOCKET
INSIDE 13
W

Attacco: 1xE27 Ø max: 6 cm L: 11,6 cm

Versione	Articolo	EUR
● nero	1007585	99,00
● ruggine	1007581	99,00



LED E27 | 8W | 240°
3000K | 880lm | Classe=E
8kWh/1000h



Articolo: 1005289 | 10,25 EUR



1007281 711



LID II
WL

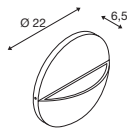

220-240V ~50/60Hz | 350mA
Potenza del sistema: 15W
Materiale: alluminio



Down 800lm | 2700K | 800lm | 3000K

Versione	Articolo	EUR
● antracite	1007282	● 109,00

LID II
WL, up/down

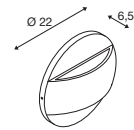

220-240V ~50/60Hz | 700mA
Potenza del sistema: 28W
Materiale: alluminio



Up 750lm | 2700K | 750lm | 3000K
Down 750lm | 2700K | 750lm | 3000K

Versione	Articolo	EUR
● antracite	1007281	● 129,00

1007667 713





LID I WL, single

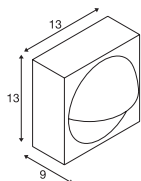

220-240V ~50/60Hz | 350mA
Potenza del sistema: 15W
Materiale: alluminio



Down 900lm | 2700K | 1050lm | 3000K

Versione	Articolo	EUR
● antracite	1007667	● 144,00

LID I WL, double

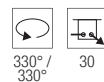
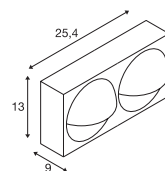

220-240V ~50/60Hz | 700mA
Potenza del sistema: 29W
Materiale: alluminio



Spot 1 850lm | 2700K | 1000lm | 3000K
Spot 2 850lm | 2700K | 1000lm | 3000K

Versione	Articolo	EUR
● antracite	1007668	● 229,00

I-RING WL

NEW



1007236 714

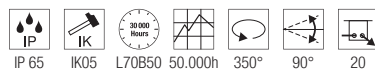
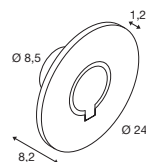

100-240V ~50/60Hz | 350mA
Potenza del sistema: 9,2W
Materiale: alluminio

LED
INSIDE

CRI
80

Down

670lm | 3000K

Versione	Articolo	EUR
● antracite	1007236	● 164,00



OVAL 14
WL, up/down

OVAL 18
WL, up/down

1007142 715

NEW



NEW

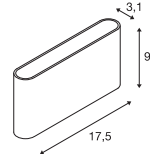
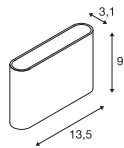

220-240V ~50/60Hz | 145mA
Potenza del sistema: 5,7W
Materiale: alluminio/policarbonato (PC)

220-240V ~50/60Hz | 275mA
Potenza del sistema: 9,3W
Materiale: alluminio/policarbonato (PC)



Up	280lm	2700K	280lm	3000K
Down	280lm	2700K	280lm	3000K

Up	430lm	2700K	430lm	3000K
Down	430lm	2700K	430lm	3000K

Versione	Articolo	EUR
● nero	1007142	73,00
○ bianco	1007143	73,00

Versione	Articolo	EUR
● nero	1007144	87,00
○ bianco	1007145	87,00

1006405 717





CONCRETO M WL

CONCRETO L WL

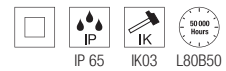
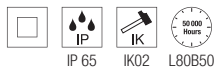
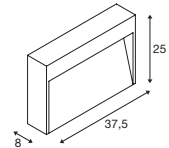
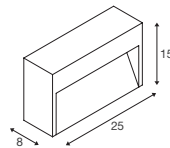

220-240V ~50/60Hz | 700mA
Potenza del sistema: 8,5W
Materiale: calcestruzzo/alluminio

220-240V ~50/60Hz | 700mA
Potenza del sistema: 12W
Materiale: calcestruzzo/alluminio



Down 270lm | 3000K

Down 470lm | 3000K

Versione	Articolo	EUR
● grigio	1006404	● 200,00

Versione	Articolo	EUR
● grigio	1006405	● 260,00

JAS DOMINICAS

ONASTERIO
A CATALINA DE SIENA



VANO WING SP, DALI

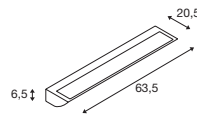

220-240V ~50/60Hz | 500mA
Potenza del sistema: 25W
Materiale: alluminio/vetro



Down 1400lm | 3000K

Versione	Articolo	EUR
● grigio	1006268	429,00

VANO WING SP, DALI

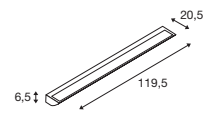

220-240V ~50/60Hz | 1050mA
Potenza del sistema: 49W
Materiale: alluminio/vetro



Down 3140lm | 3000K

Versione	Articolo	EUR
● grigio	1006270	529,00

MANA BASE
WL, rotondo, PHASE

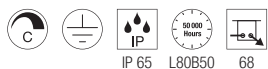
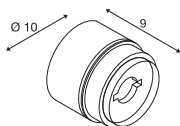

220-240V ~50/60Hz | 350mA
Potenza del sistema: 15W
Materiale: alluminio/policarbonato (PC)



Down 800lm | 2700K | 820lm | 3000K

Versione	Articolo	EUR
● antracite	1006319	189,00

RUSTY® MANA
Diffusore, quadrato



NEW

L: 28 cm La: 28 cm H: 1,5 cm
Materiale: acciaio FeCSi

Versione	Articolo	EUR
● ruggine	1006317	59,00

RUSTY® MANA
Diffusore, rotondo



NEW

H: 1,5 cm Ø: 28 cm
Materiale: acciaio FeCSi

Versione	Articolo	EUR
● ruggine	1006318	59,00

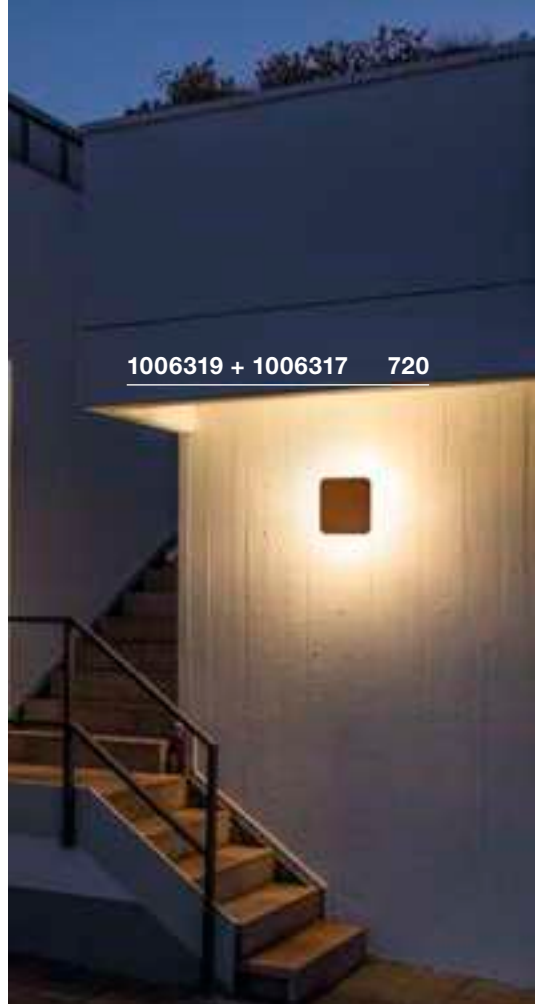

1006319 + 1006317 720



1003470 721



1002902 721



MANA OUT WL, PHASE

MANA OUT WL, Set

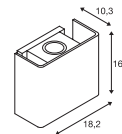
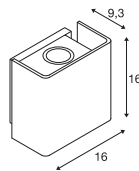
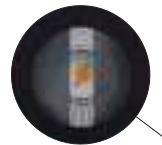

220-240V ~50/60Hz | 500mA
Potenza del sistema: 11W
Materiale: alluminio/alluminio

220-240V ~50/60Hz | 500mA
Potenza del sistema: 11W
Materiale: alluminio/calcestruzzo



Up 325lm | 3000K
Down 325lm | 3000K

Up 325lm | 3000K
Down 325lm | 3000K

Versione	Articolo	EUR
● antracite	1002900	239,00
● ruggine	1002902	239,00

Versione	Articolo	EUR
● grigio	1003470	272,00

1006328 723

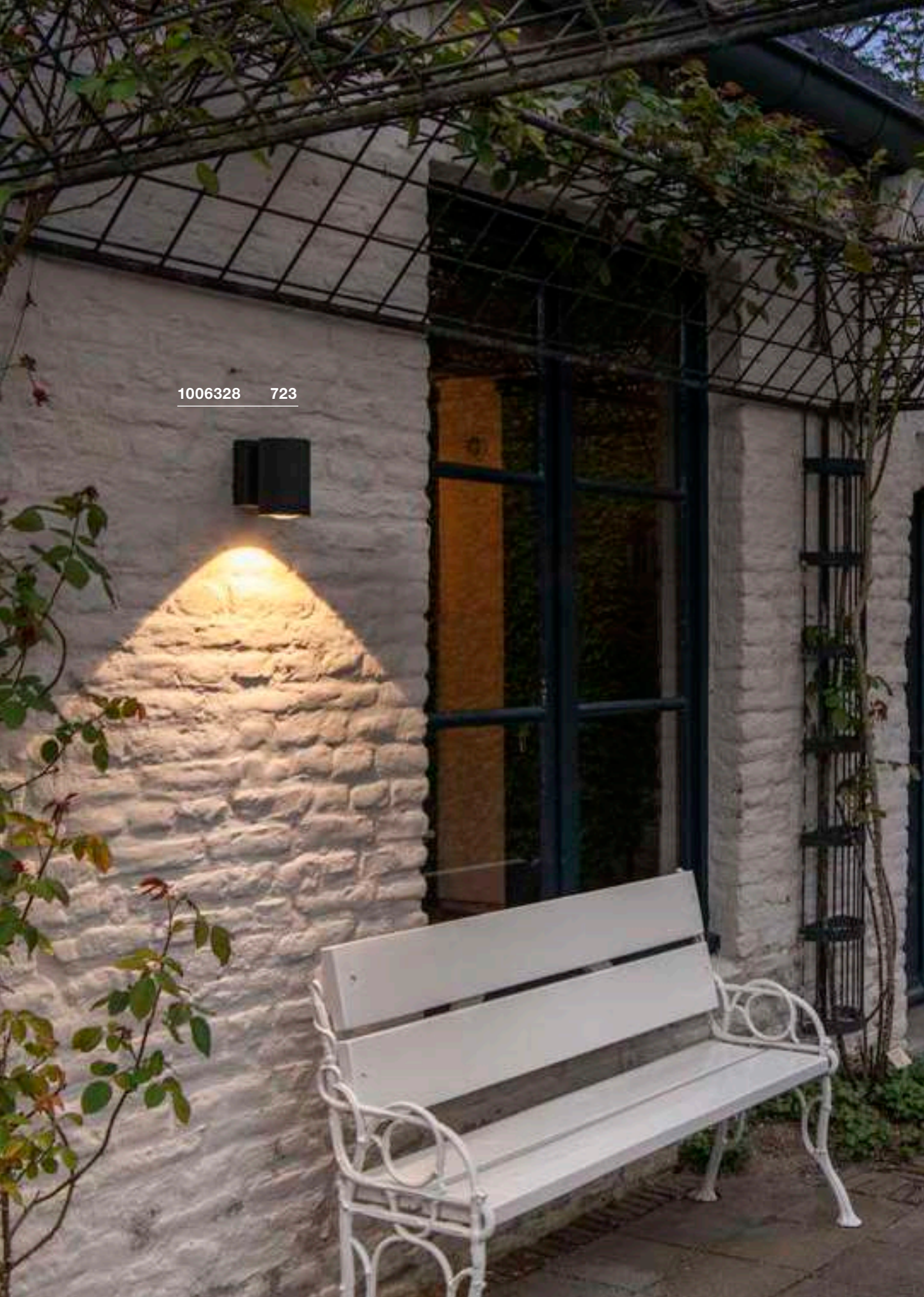



ENOLA OCULUS WL, single



ENOLA OCULUS WL, up/down



1006329 723

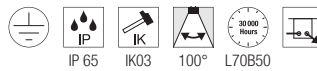
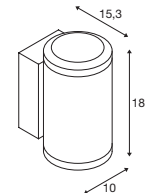
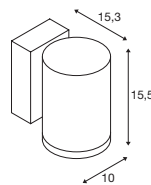

220-240V ~50/60Hz | 500mA
Potenza del sistema: 11W
Materiale: alluminio/vetro

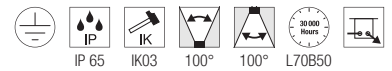

220-240V ~50/60Hz | 500mA
Potenza del sistema: 20W
Materiale: alluminio/vetro



Down	1000lm 3000K	1100lm 4000K
------	----------------	----------------



Up	940lm 3000K	1060lm 4000K
Down	940lm 3000K	1060lm 4000K

Versione	Articolo	EUR
● antracite	1006328	● 273,00

Versione	Articolo	EUR
● antracite	1006329	● 344,00



Articolo	Articolo	EUR
Set distanziatori		
● antracite	1002853	7,75



Articolo	Articolo	EUR
Set distanziatori		
● antracite	1002853	7,75

1003440 725





ENOLA ROUND S WL, single

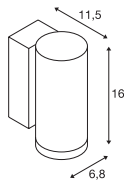

100-240V ~50/60Hz | 500mA
Potenza del sistema: 6W
Materiale: alluminio/vetro



Down 450lm | 3000K | 500lm | 4000K

Versione	Articolo	EUR
● antracite	1003422	200,00



Articolo	Articolo	EUR
Set distanziatori		
● antracite	1002853	7,75
Riflettore da 60°		
● cromo	1005262	16,40

ENOLA ROUND M WL, single

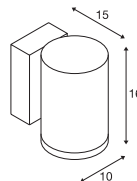

220-240V ~50/60Hz | 500mA
Potenza del sistema: 11W
Materiale: alluminio/vetro



Down 860lm | 3000K | 980lm | 4000K

Versione	Articolo	EUR
● antracite	1003423	245,00



Articolo	Articolo	EUR
Set distanziatori		
● antracite	1002853	7,75
Lente da 19°		
● nero/cromo	1005205	41,75
Lente asimmetrica		
● nero/cromo	1005206	41,75
Riflettore da 60°		
● cromo	1005207	24,75

ENOLA ROUND L WL, single

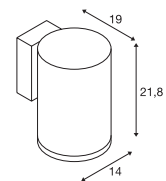

220-240V ~50/60Hz | 900mA
Potenza del sistema: 36W
Materiale: alluminio/vetro



Down 3300lm | 3000K | 3700lm | 4000K

Versione	Articolo	EUR
● antracite	1003440	343,00



Articolo	Articolo	EUR
Set distanziatori		
● antracite	1002853	7,75
Riflettore da 60°		
● cromo	1005263	21,50



1003441 727



ENOLA ROUND S UP/DOWN WL

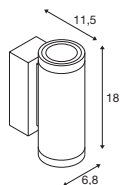

10

220-240V ~50/60Hz | 350mA
Potenza del sistema: 7,8W
Materiale: alluminio/vetro



Up	310lm	3000K	350lm	4000K
Down	310lm	3000K	350lm	4000K

Versione	Articolo	EUR
● antracite	1003424	245,00



Articolo	Articolo	EUR
Set distanziatori		
● antracite	1002853	7,75
Riflettore da 60°		
● cromo	1005262	16,40

ENOLA ROUND M UP/DOWN WL

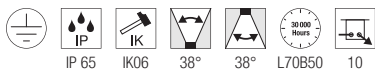
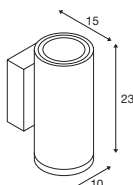

220-240V ~50/60Hz | 500mA
Potenza del sistema: 20W
Materiale: alluminio/vetro



Up	830lm	3000K	950lm	4000K
Down	830lm	3000K	950lm	4000K

Versione	Articolo	EUR
● antracite	1003425	300,00



Articolo	Articolo	EUR
Set distanziatori		
● antracite	1002853	7,75
Lente da 19°		
● nero/cromo	1005205	41,75
Lente asimmetrica		
● nero/cromo	1005206	41,75
Riflettore da 60°		
● cromo	1005207	24,75

ENOLA ROUND L UP/DOWN WL

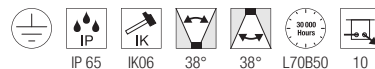
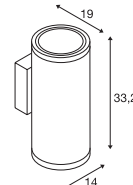

220-240V ~50/60Hz | 700mA
Potenza del sistema: 55W
Materiale: alluminio/vetro



Up	2700lm	3000K	3000lm	4000K
Down	2700lm	3000K	3000lm	4000K

Versione	Articolo	EUR
● antracite	1003441	470,00



Articolo	Articolo	EUR
Set distanziatori		
● antracite	1002853	7,75
Riflettore da 60°		
● cromo	1005263	21,50



1003416 729



1003417 729



ENOLA SQUARE S WL, single

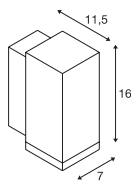

100-240V ~50/60Hz | 500mA
Potenza del sistema: 6W
Materiale: alluminio/vetro



Down 450lm | 3000K | 500lm | 4000K

Versione	Articolo	EUR
● antracite	1003416	200,00



Articolo	Articolo	EUR
Set distanziatori		
● antracite	1002853	7,75
Riflettore da 60°		
● cromo	1005262	16,40

ENOLA SQUARE M WL, single

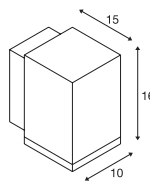

220-240V ~50/60Hz | 500mA
Potenza del sistema: 11W
Materiale: alluminio/vetro



Down 860lm | 3000K | 980lm | 4000K

Versione	Articolo	EUR
● antracite	1003417	245,00



Articolo	Articolo	EUR
Set distanziatori		
● antracite	1002853	7,75
Lente da 19°		
● nero/cromo	1005205	41,75
Lente asimmetrica		
● nero/cromo	1005206	41,75
Riflettore da 60°		
● cromo	1005207	24,75

ENOLA SQUARE L WL, single

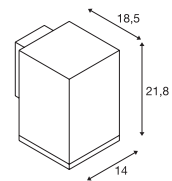

220-240V ~50/60Hz | 900mA
Potenza del sistema: 36W
Materiale: alluminio/vetro



Down 3300lm | 3000K | 3700lm | 4000K

Versione	Articolo	EUR
● antracite	1003437	343,00



Articolo	Articolo	EUR
Set distanziatori		
● antracite	1002853	7,75
Riflettore da 60°		
● cromo	1005263	21,50

ENOLA SQUARE S UP/DOWN WL

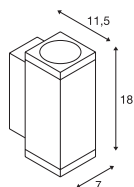

220-240V ~50/60Hz | 350mA
Potenza del sistema: 7,8W
Materiale: alluminio/vetro



Up	310lm	3000K	350lm	4000K
Down	310lm	3000K	350lm	4000K

Versione	Articolo	EUR
● antracite	1003418	245,00



Articolo	Articolo	EUR
Set distanziatori		
● antracite	1002853	7,75
Riflettore da 60°		
● cromo	1005262	16,40

ENOLA SQUARE M UP/DOWN WL

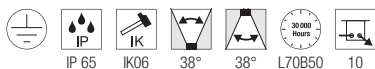
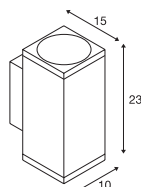

220-240V ~50/60Hz | 500mA
Potenza del sistema: 20W
Materiale: alluminio/vetro



Up	830lm	3000K	950lm	4000K
Down	830lm	3000K	950lm	4000K

Versione	Articolo	EUR
● antracite	1003419	300,00



Articolo	Articolo	EUR
Set distanziatori		
● antracite	1002853	7,75
Lente da 19°		
● nero/cromo	1005205	41,75
Lente asimmetrica		
● nero/cromo	1005206	41,75
Riflettore da 60°		
● cromo	1005207	24,75

ENOLA SQUARE L UP/DOWN WL

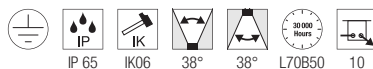
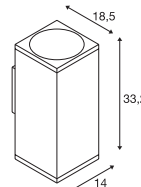

220-240V ~50/60Hz | 700mA
Potenza del sistema: 55W
Materiale: alluminio/vetro



Up	2700lm	3000K	3000lm	4000K
Down	2700lm	3000K	3000lm	4000K

Versione	Articolo	EUR
● antracite	1003438	470,00



Articolo	Articolo	EUR
Set distanziatori		
● antracite	1002853	7,75
Riflettore da 60°		
● cromo	1005263	21,50



ENOLA S, M, L
Riflettore, 60°



60°

S | H: 1,85 cm Ø: 4,5 cm
M | H: 4,00 cm Ø: 7,5 cm
L | H: 6,96 cm Ø: 11 cm
Materiale: policarbonato (PC)



ENOLA M
Lente, 19°



34 / 12°

H: 3,8 cm
Ø: 7,5 cm
Materiale: acciaio/policarbonato (PC)



ENOLA M
Lente asimmetrica



48 / 23°

H: 3 cm
Ø: 7,5 cm
Materiale: acciaio/policarbonato (PC)



Versione	Articolo	EUR
● cromo S	1005262	16,40
● cromo M	1005207	24,75
● cromo L	1005263	21,50

Versione	Articolo	EUR
●● nero/cromo	1005205	41,75

Versione	Articolo	EUR
●● nero/cromo	1005206	41,75



EASY TO INSTALL

1

FISSAGGIO A PARETE

Avvitare la piastra di montaggio alla parete

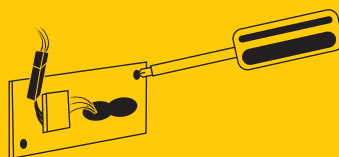

2

COLLEGAMENTO SEMPLICE E PULITO

Inserire il connettore rapido per l'alimentazione

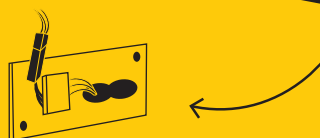

3

MONTAGGIO RAPIDO E SALDO

Agganciare l'apparecchio alla tacca di inserzione sulla piastra di montaggio e bloccarlo stringendo le apposite viti



FATTO!

Proprio perché l'efficienza paga sempre, gli apparecchi SLV si installano con facilità, rapidità e sicurezza. L'utilizzo di piastre di montaggio fisse, copri lampada agganciabili, collegamenti con morsetti a molla, cablaggio passante per collegamenti in serie e altre caratteristiche offrono vantaggi decisivi: risparmio di tempo, sforzo e denaro.

CORPI LAMPADA AGGANCIABILI

Anche nella serie ENOLA® il corpo lampada viene agganciato alla piastra di montaggio avvitata alla parete. Così, dopo il fissaggio tramite la tacca di inserzione e il collegamento elettrico tramite connettore rapido, entrambe le mani rimangono libere per avvitare in modo sicuro la lampada.

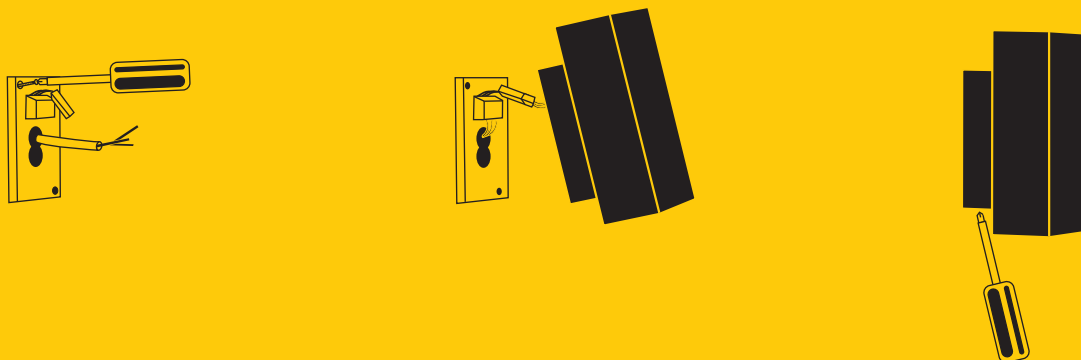

PRATICI MORSETTI A PRESSIONE

Le lampade da parete SITRA CUBE sono rapide e semplici da installare: è sufficiente inserire i conduttori di alimentazione nella morsettiere a pressione senza attrezzi sulla piastra di montaggio e collegare il connettore rapido dell'apparecchio: fatto!



CABLAGGIO PASSANTE

Le lampade QUADRULO mostrano con quale semplicità funziona il collegamento in serie. Nella piastra di base dell'apparecchio sono predisposti due passaggi dei cavi. Anche le connessioni con morsetto a pressione dispongono di doppio ingresso per ogni conduttore, in questa maniera è possibile installare in modo rapido e semplice più apparecchi in cascata.





229532 735



234515 735



THEO UP/DOWN WL, QPAR51

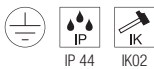
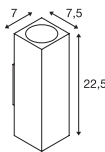

220-240V ~50/60Hz
Materiale: alluminio/vetro



Attacco: 2xGU10

Versione	Articolo	EUR
● antracite	229535	90,00
○ bianco	229531	90,00
● grigio	229532	90,00



LED GU10 51mm | 6W | 38°
2700K | 450lm | Classe=F
6kWh/1000h



Articolo: 1005077 | 7,50 EUR

BIG THEO BEAM UP/ FLOOD DOWN WL

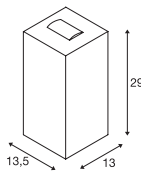

220-240V ~50/60Hz | 500mA
Potenza del sistema: 29W
Materiale: alluminio/vetro



Up 130lm | 3000K
Down 2000lm | 3000K

Versione	Articolo	EUR
● antracite	234515	279,00

BIG THEO UP/DOWN WL, QPAR111

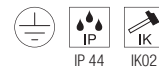
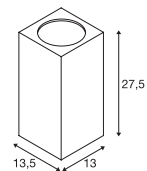

220-240V ~50/60Hz
Materiale: alluminio/vetro



Attacco: 2xGU10

Versione	Articolo	EUR
● antracite	229575	179,00
● grigio	229574	179,00



QPAR111 | 12,5W | 10°
3000K | 950lm | Classe=F
13kWh/1000h



Articolo: 1005278 | 55,00 EUR

BIG THEO FLOOD UP/DOWN
WL

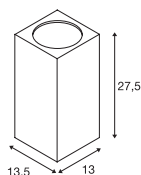

220-240V ~50/60Hz | 1000mA
Potenza del sistema: 42W
Materiale: alluminio/vetro



Up 2000lm | 3000K
Down 2000lm | 3000K

Versione	Articolo	EUR
● antracite	234505	314,00

THEO
WL, QPAR51

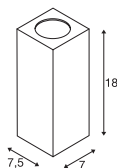

220-240V ~50/60Hz
Materiale: alluminio/vetro



Attacco: 1xGU10

Versione	Articolo	EUR
● antracite	229525	75,00
● grigio	229524	75,00



LED GU10 51mm | 6W | 38°
2700K | 450lm | Classe=F
6kWh/1000h



Articolo: 1005077 | 7,50 EUR



234505 736





BIG THEO WL, QPAR111

BIG THEO WL

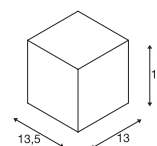
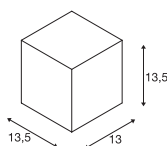

IP 44

220-240V ~50/60Hz
Materiale: alluminio/vetro



Attacco: 1xGU10

Versione	Articolo	EUR
● antracite	229565	113,00
● grigio	229564	113,00



QPAR111 | 12,5W | 10°
3000K | 950lm | Classe=F
13kWh/1000h



Articolo: 1005278 | 55,00 EUR



100-277V ~50/60Hz | 500mA
Potenza del sistema: 21W
Materiale: alluminio/vetro



Down

2000lm | 3000K

Versione	Articolo	EUR
● antracite	234525	224,00

234525 737



1002032 739



SITRA S WL, single, quadrato

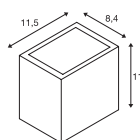

100-277V ~50/60Hz | 500mA
Potenza del sistema: 11W
Materiale: alluminio



Up	550lm	3000K	635lm	4000K
Down	550lm	3000K	635lm	4000K

Versione	Articolo	EUR
● antracite	1002032	119,00
○ bianco	1002033	119,00
● ruggine	1002034	119,00

SITRA S WL, single, quadrato

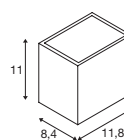

220-240V ~50/60Hz | 500mA
Potenza del sistema: 6,2W
Materiale: alluminio/vetro



Down	580lm	3000K	620lm	4000K
------	-------	-------	-------	-------

Versione	Articolo	EUR
● antracite	1005148	99,00
○ bianco	1005149	99,00
● ruggine	1005150	99,00

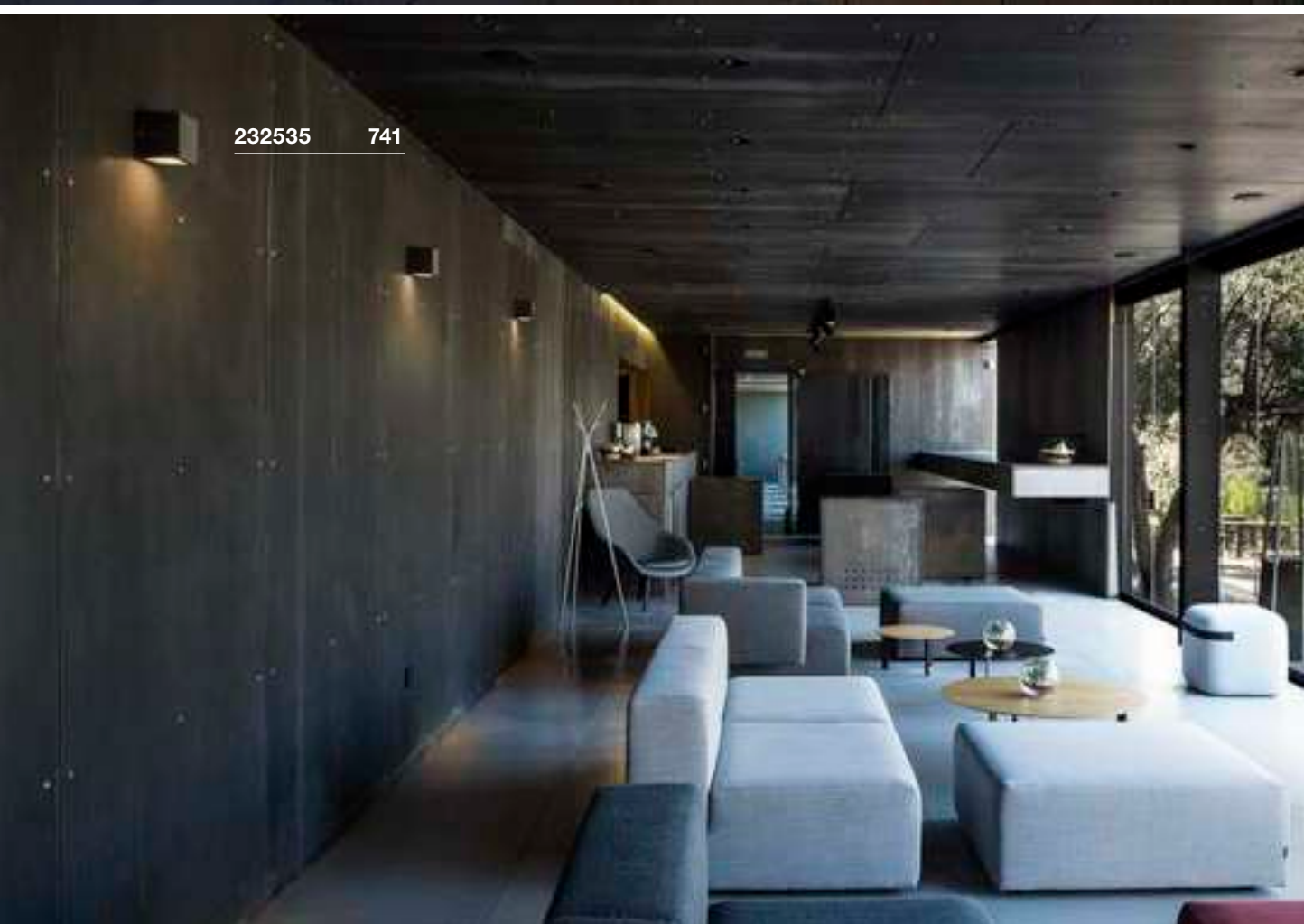



SITRA M
WL, up/down, quadrato

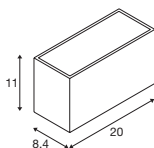

220-240V ~50/60Hz | 350mA
Potenza del sistema: 14W
Materiale: alluminio



Up	850lm	3000K	940lm	4000K
Down	850lm	3000K	940lm	4000K

Versione	Articolo	EUR
● antracite		
1700 / 1880lm	1005151	145,00
○ bianco		
1700 / 1880lm	1005153	145,00
● ruggine		
1600 / 1700lm	1005154	145,00

SITRA L
WL, up/down, quadrato

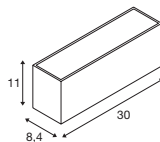

220-240V ~50/60Hz | 600mA
Potenza del sistema: 24W
Materiale: alluminio



Up	1400lm	3000K	1530lm	4000K
Down	1400lm	3000K	1530lm	4000K

Versione	Articolo	EUR
● antracite	1005155	184,00
○ bianco	1005156	184,00
● ruggine	1005157	184,00

SITRA CUBE
WL, TCR-TSE

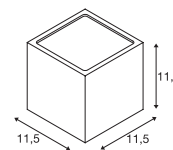

220-240V ~50/60Hz
Materiale: alluminio/vetro



Attacco: 2xGX53 Ø max: 7,5 cm L: 2,7 cm

Versione	Articolo	EUR
● antracite	232535	78,00
○ bianco	232531	78,00
● ruggine	232537	78,00



LED GX53 | 6,1W | 120°
3000K | 490lm | Classe=G
6kWh/1000h



Articolo: **1005271** | **11,50 EUR**

GRAFIT
WL, rotondo, sensore, E27

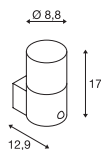

GRAFIT
WL, rotondo, E27

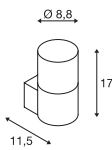

1006178 742



220-240V ~50/60Hz
Materiale: alluminio/acrilico

- Sensore di movimento



Attacco: 1xE27 Ø max: 6 cm L: 11,5 cm

Versione	Articolo	EUR
● antracite	1006179	90,00



220-240V ~50/60Hz
Materiale: alluminio/acrilico



Attacco: 1xE27 Ø max: 6 cm L: 11,5 cm

Versione	Articolo	EUR
● antracite	1006178	80,00



LED E27 | 8W | 240°
3000K | 880lm | Classe=E
8kWh/1000h



Articolo: 1005289 | 10,25 EUR



A60 | 7,5W | 320°
2700K | 800lm | Classe=F
8kWh/1000h



Articolo: 1005303 | 9,60 EUR



GRAFIT
WL, quadrato, sensore, E27

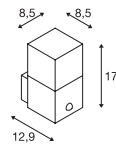

GRAFIT
WL, quadrato, E27

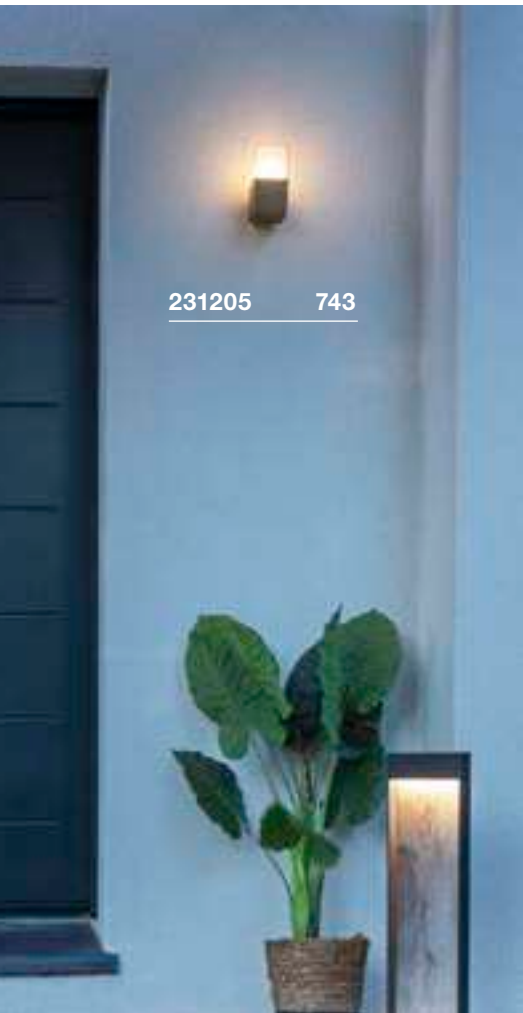
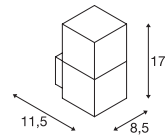

231205 743



220-240V ~50/60Hz
Materiale: alluminio/acrilico

- Sensore di movimento



Attacco: 1xE27 Ø max: 6 cm L: 11,5 cm

Versione	Articolo	EUR
● antracite	1006183	90,00



A60 | 7,5W | 320°
2700K | 800lm | Classe=F
8kWh/1000h



Articolo: 1005303 | 9,60 EUR



220-240V ~50/60Hz
Materiale: alluminio/plastica



Attacco: 1xE27 Ø max: 6 cm L: 11,5 cm

Versione	Articolo	EUR
● antracite	231205	80,00



A60 | 7,5W | 320°
2700K | 800lm | Classe=F
8kWh/1000h



Articolo: 1005303 | 9,60 EUR

QUADRULO WL

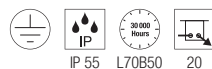
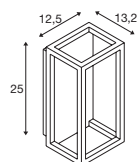

100-277V ~50/60Hz | 350mA
Potenza del sistema: 7,4W
Materiale: alluminio/polivinilcloruro (PVC)

LED
INSIDE

CRI
80

Down 270lm | 280lm | 3000K

Versione	Articolo	EUR
● antracite 270lm	1005201	166,00
●● antracite/legno 280lm	1007207	149,00



1002402 745

QUADRULO SENSOR
WL, E27

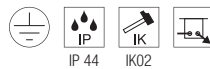
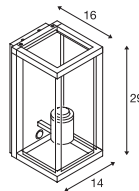

220-240V ~50/60Hz
Materiale: alluminio/vetro

- Sensore di movimento



Attacco: 1xE27 Ø max: 8 cm L: 18 cm

Versione	Articolo	EUR
● antracite	1002402	172,00



LED E27 | 7,5W | 320°
2500K | 700lm | Classe=F
8kWh/1000h



Articolo: 1005265 | 26,50 EUR

QUADRULO
WL, E27

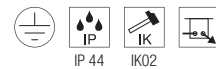
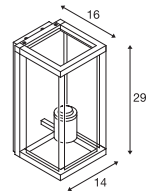

220-240V ~50/60Hz
Materiale: alluminio/vetro



Attacco: 1xE27 Ø max: 8 cm L: 18 cm

Versione	Articolo	EUR
● antracite	1002403	149,00



LED E27 | 7,5W | 320°
2500K | 700lm | Classe=F
8kWh/1000h



Articolo: 1005265 | 26,50 EUR



1002403 745

MERIDIAN
WL, E27

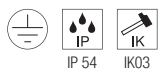
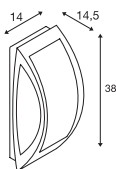

220-240V ~50/60Hz
Materiale: alluminio/policarbonato (PC)



Attacco: 1xE27 Ø max: 7 cm L: 17,5 cm

Versione	Articolo	EUR
● antracite	230445	79,00
● grigio	230444	79,00



LED E27 | 8W | 240°
3000K | 880lm | Classe=E
8kWh/1000h



Articolo: 1005289 | 10,25 EUR

MERIDIAN BOX
WL, E27

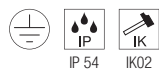
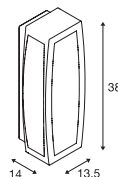

220-240V ~50/60Hz
Materiale: alluminio/policarbonato (PC)



Attacco: 1xE27 Ø max: 7 cm L: 17,5 cm

Versione	Articolo	EUR
● antracite	230045	100,00
● grigio	230044	100,00



| 13,5W | 240°
4000K | 1600lm | Classe=E
14kWh/1000h



Articolo: 1005308 | 12,50 EUR





230445 746

MERIDIAN BOX SENSOR WL, E27

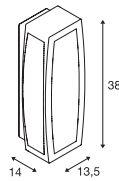

220-240V ~50/60Hz
Materiale: alluminio/polycarbonato (PC)

- Sensore di movimento



Attacco: 1xE27 Ø max: 7 cm L: 17,5 cm

Versione	Articolo	EUR
● antracite	230085	166,00
● grigio	230084	166,00



LED E27 | 8W | 240°
3000K | 880lm | Classe=E
8kWh/1000h



Articolo: 1005289 | 10,25 EUR

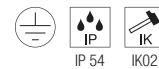

220-240V ~50/60Hz
Materiale: alluminio/polycarbonato (PC)



Attacco: 1xE27 Ø max: 7 cm L: 17,5 cm

Versione	Articolo	EUR
● antracite	230655	112,00
● ruggine	230657	112,00



LED E27 | 7,5W | 320°
2500K | 700lm | Classe=F
8kWh/1000h



Articolo: 1005265 | 26,50 EUR



230655 747

1004748 749



1006314 749

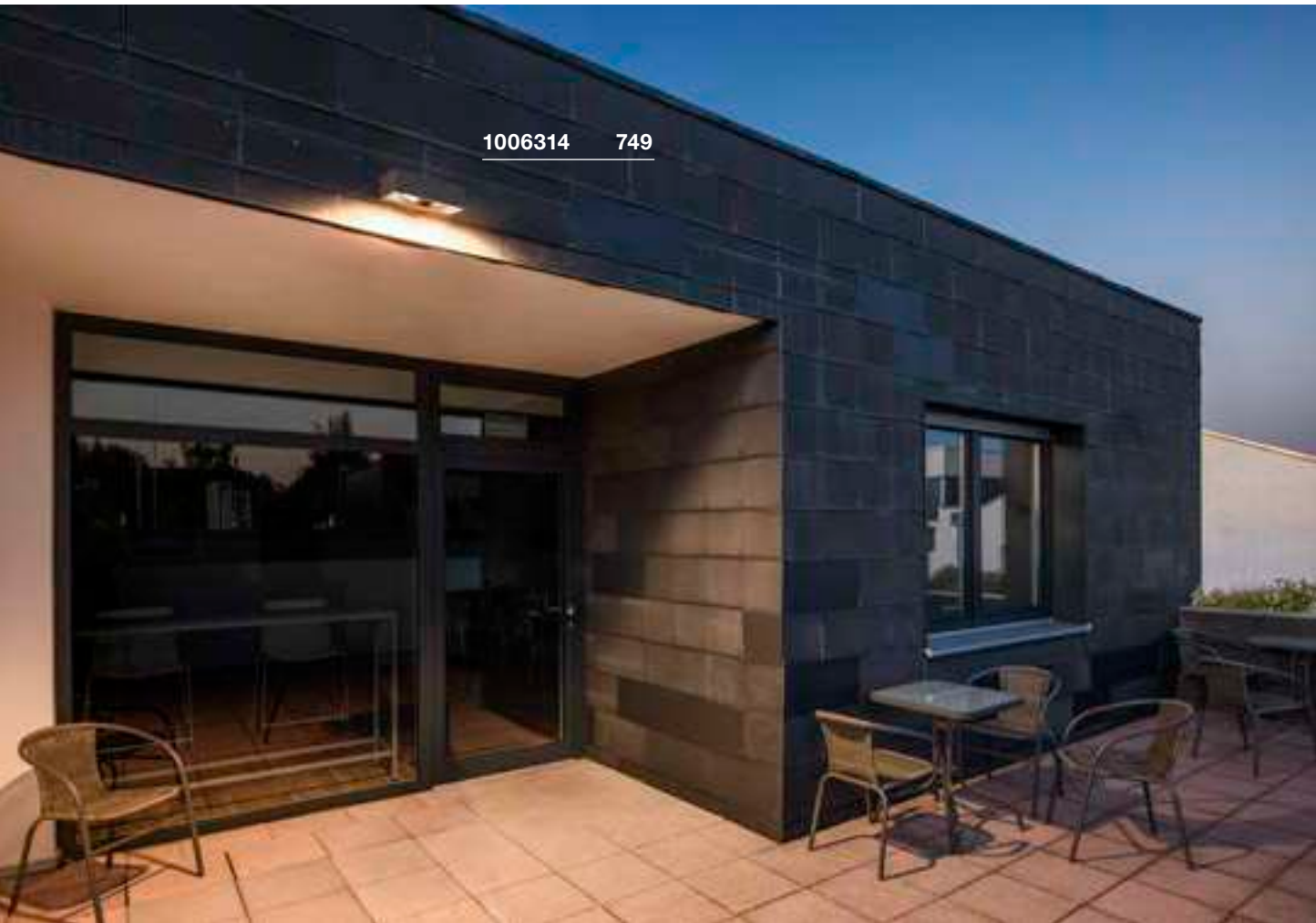



ESKINA FRAME WL

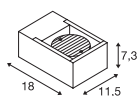

220-240V ~50/60Hz | 350mA
Potenza del sistema: 15W
Materiale: alluminio



Down	1100lm 3000K	1200lm 4000K
------	----------------	----------------

Versione	Articolo	EUR
● antracite	1004747	222,00

ESKINA FRAME WL, double

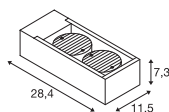

220-240V ~50/60Hz | 700mA
Potenza del sistema: 27W
Materiale: alluminio



Spot 1	1100lm 3000K	1200lm 4000K
Spot 2	1100lm 3000K	1200lm 4000K

Versione	Articolo	EUR
● antracite	1004748	272,00

ESKINA FRAME WL, double

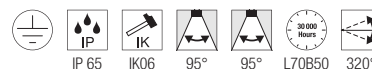
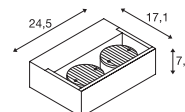

220-240V ~50/60Hz | 700mA
Potenza del sistema: 27W
Materiale: alluminio



Spot 1	1100lm 3000K	1200lm 4000K
Spot 2	1100lm 3000K	1200lm 4000K

Versione	Articolo	EUR
● antracite	1006314	272,00

1005443 751

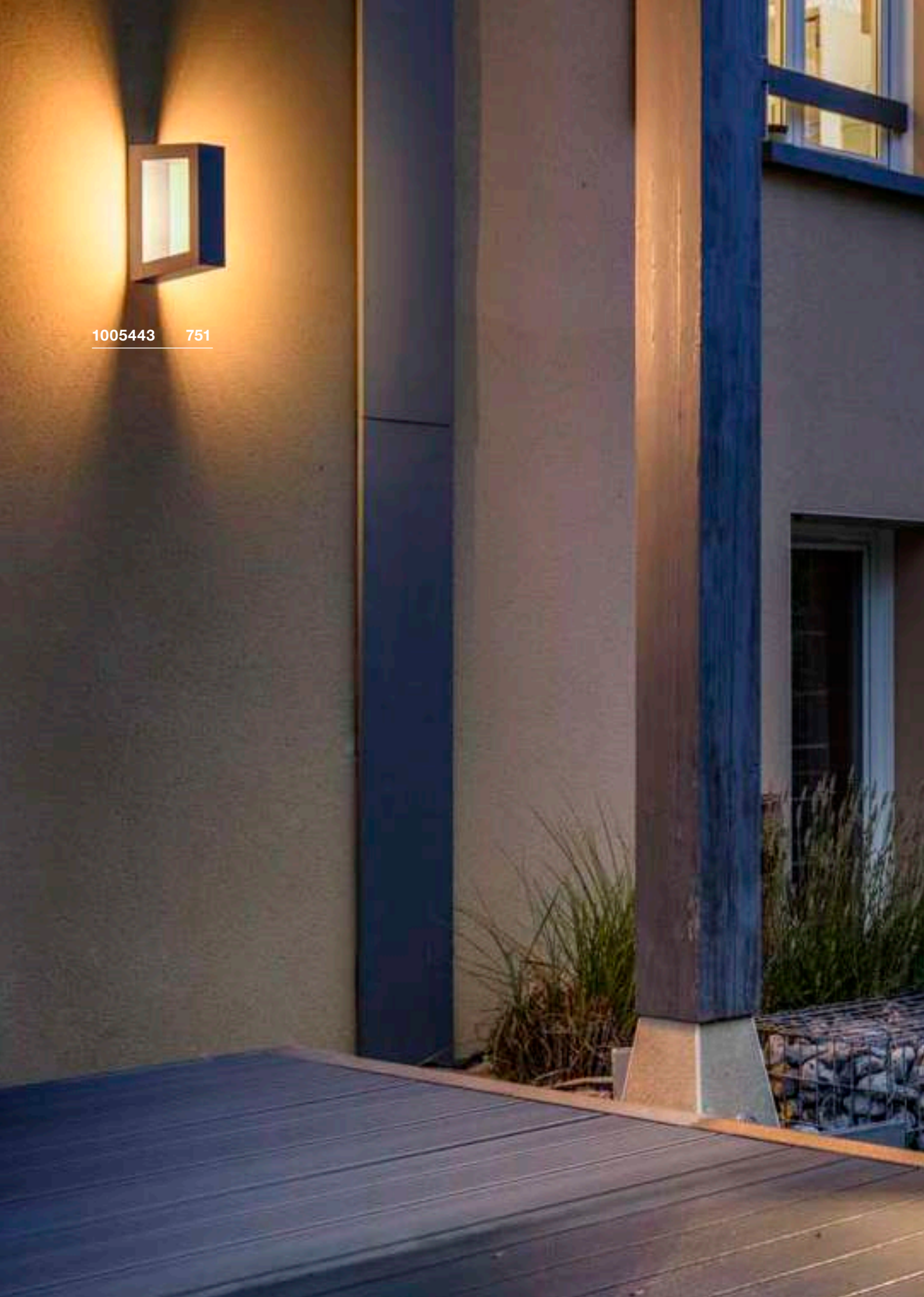



BOOKAT WL

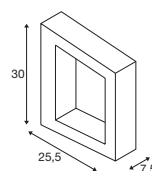

1005441 683



100-277V ~50/60Hz | 700mA
Potenza del sistema: 15W
Materiale: alluminio



Down 920lm | 3000K | 990lm | 4000K

Versione	Articolo	EUR
● antracite	1005443	201,00

BIG QUAD WL

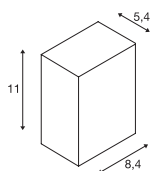

100-240V ~50/60Hz | 350mA
Potenza del sistema: 4,5W
Materiale: alluminio/vetro



Down 260lm | 3000K

Versione	Articolo	EUR
● antracite	232435	119,00

QUAD WL

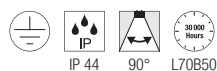
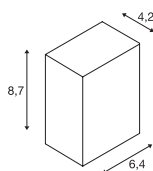

200-240V ~50/60Hz | 700mA
Potenza del sistema: 4,6W
Materiale: alluminio/vetro



Down 80lm | 3000K
100lm | 3000K

Versione	Articolo	EUR
● antracite	232465	84,00
○ bianco	232461	84,00





QUAD UP/DOWN 15 WL

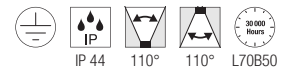
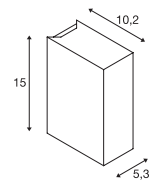

100-277V ~50/60Hz | 350mA
Potenza del sistema: 8W
Materiale: alluminio/vetro



Up	260lm	3000K
Down	260lm	3000K



Versione	Articolo	EUR
● antracite 520lm	232445	129,00
○ bianco 580lm	232441	129,00

1005126 755

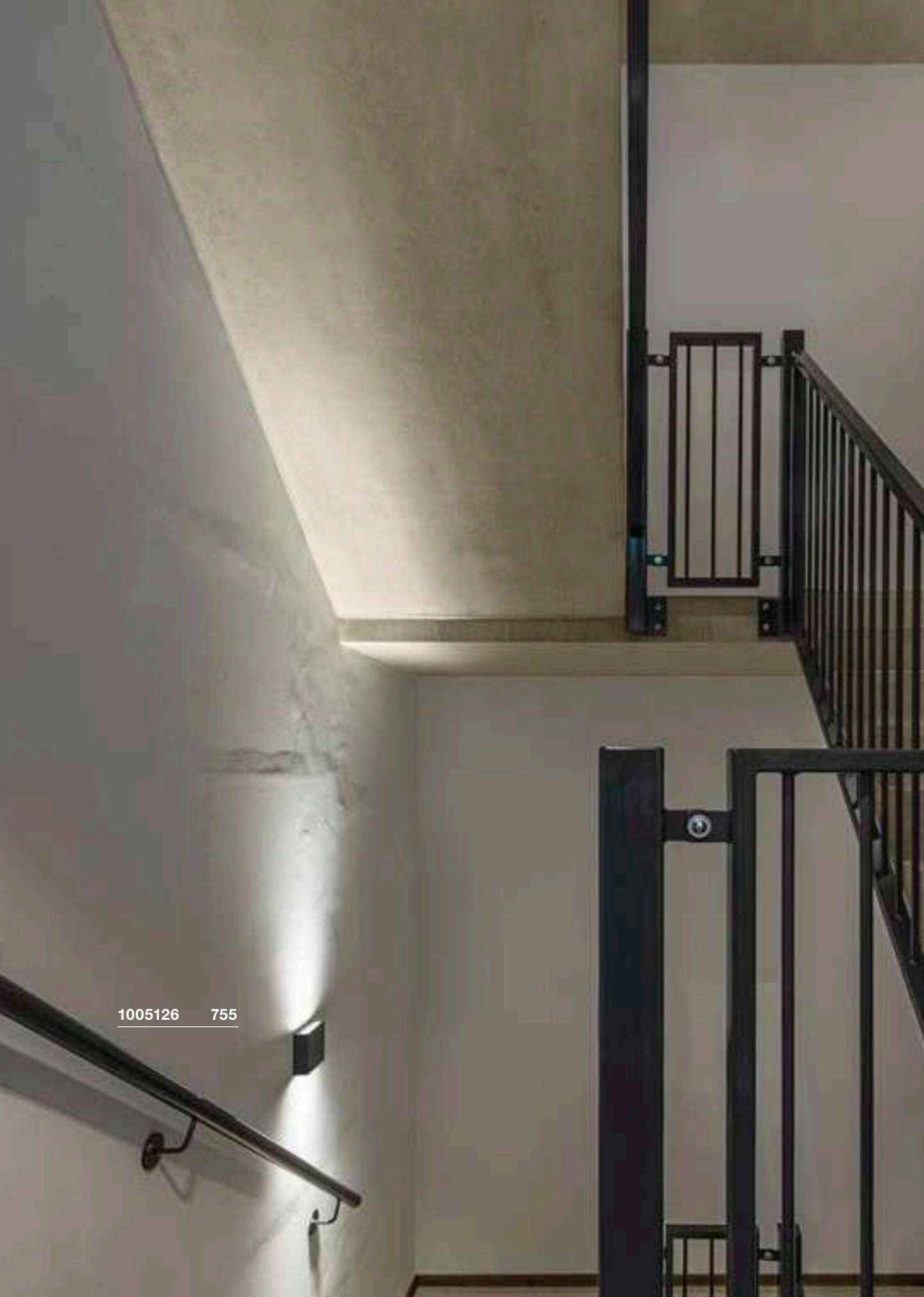



BIG QUAD UP/DOWN WL

BIG QUAD WL

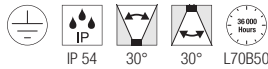
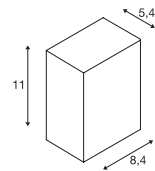
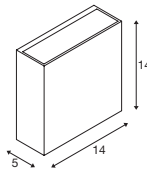

220-240V ~50/60Hz | 500mA
Potenza del sistema: 8,2W
Materiale: alluminio/vetro

100-240V ~50/60Hz | 350mA
Potenza del sistema: 4,5W
Materiale: alluminio/vetro



Up 320lm | 3000K
Down 320lm | 3000K

Down 290lm | 3000K

Versione	Articolo	EUR
● antracite	1005126	169,00
○ bianco	1005125	169,00

Versione	Articolo	EUR
○ bianco	232431	119,00

RUSTY® UP/DOWN
WL, quadrato

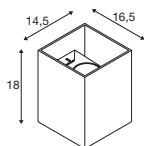

220-240V ~50/60Hz | 350mA
Potenza del sistema: 14W
Materiale: acciaio FeCSi/alluminio



Up	259lm	3000K	260lm	4000K
Down	285lm	3000K	288lm	4000K

Versione	Articolo	EUR
●● ruggine/antracite	1004650	282,00

RUSTY® UP/DOWN
WL, rotondo

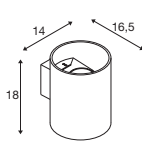

220-240V ~50/60Hz | 350mA
Potenza del sistema: 14W
Materiale: acciaio FeCSi/alluminio



Up	249lm	3000K	254lm	4000K
Down	267lm	3000K	271lm	4000K

Versione	Articolo	EUR
●● ruggine/antracite	1004651	282,00





OVALISK SENSOR WL

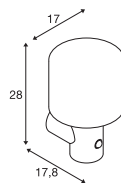

OVALISK WL

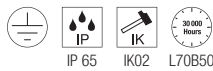
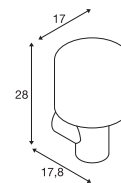

220-240V ~50/60Hz | 500mA
Potenza del sistema: 9,6W
Materiale: alluminio/vetro

- Sensore di movimento



Down 580lm | 3000K | 630lm | 4000K

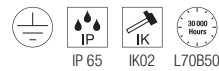

220-240V ~50/60Hz | 500mA
Potenza del sistema: 9,2W
Materiale: alluminio/vetro



Down 580lm | 3000K | 630lm | 4000K



1004679 757

Versione	Articolo	EUR
● antracite	1004679	289,00

Versione	Articolo	EUR
● antracite	1004678	272,00

PEMA®
WL

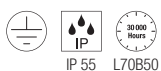
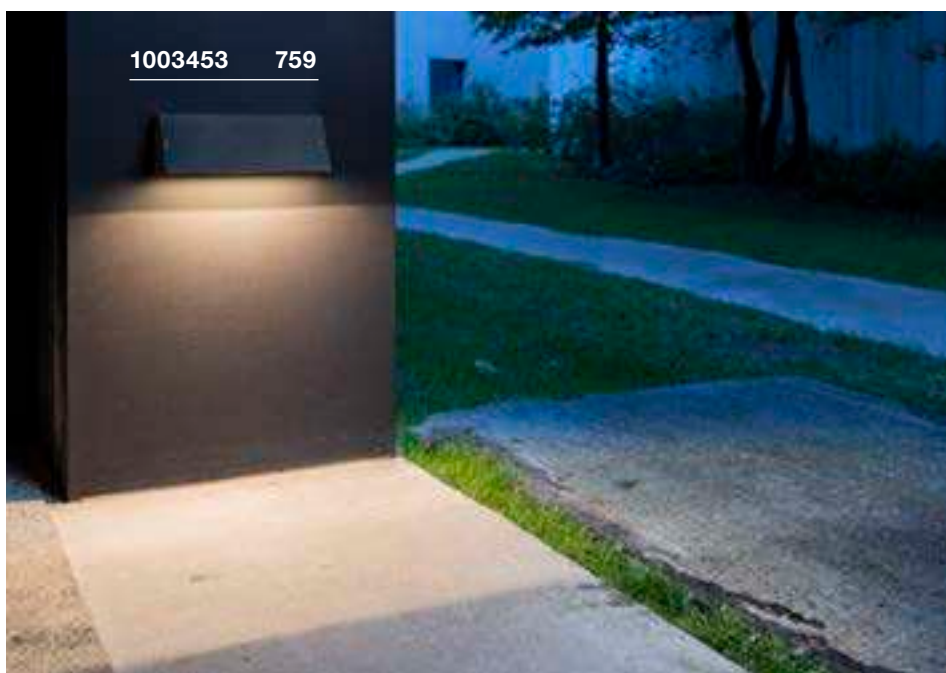
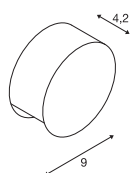
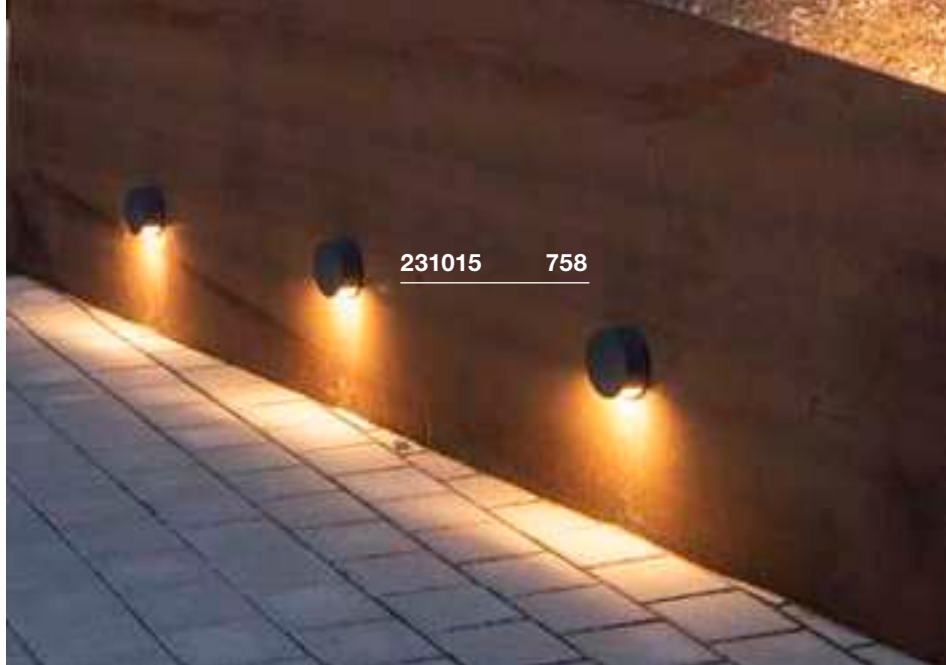

220-240V ~50/60Hz
Potenza del sistema: 3,8W
Materiale: alluminio/policarbonato (PC)

- Classe di protezione IP55 solo in caso di montaggio con emissione verso il basso.



Down 170lm | 3000K

Versione	Articolo	EUR
● antracite	231015	118,00
○ bianco	231010	118,00
● grigio	231012	118,00





PEMA®
WL

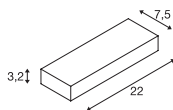

220-240V ~50/60Hz
Potenza del sistema: 7,7W
Materiale: alluminio/vetro



Down 640lm | 3000K

Versione	Articolo	EUR
● antracite	1002069	131,00
○ bianco	1002070	131,00

PEMA®
WL

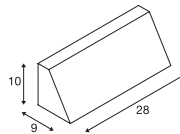

100-277V ~50/60Hz | 350mA
Potenza del sistema: 14W
Materiale: alluminio/vetro



Down 1340lm | 3000K | 1420lm | 4000K

Versione	Articolo	EUR
● nero	1003453	147,00
● grigio	1003454	147,00

PEMA®
WL, E27

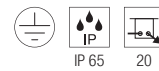
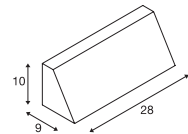

220-240V ~50/60Hz
Materiale: alluminio/vetro



Attacco: 1xE27 Ø max: 4,5 cm | L: 21 cm

Versione	Articolo	EUR
● nero	230030	106,00
● grigio	230034	106,00



LED E27 | 8W | 240°
3000K | 880lm | Classe=E
8kWh/1000h



Articolo: 1005289 | 10,25 EUR

FLATT SENSOR WL

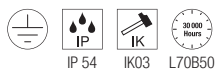
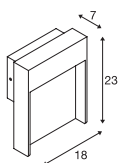

100-240V ~50/60Hz | 300mA
Potenza del sistema: 13W
Materiale: alluminio/alluminio

- Sensore di movimento



Down 500lm | 3000K | 550lm | 4000K

Versione	Articolo	EUR
● antracite 500 / 530lm	1002954	211,00
●● antracite/marrone 500 / 550lm	1002955	211,00

FLATT WL

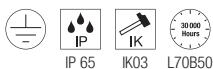
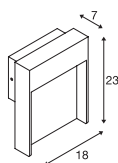

100-240V ~50/60Hz | 300mA
Potenza del sistema: 13W
Materiale: alluminio/alluminio



Down 500lm | 3000K | 530lm | 4000K

Versione	Articolo	EUR
● antracite 500 / 530lm	1002952	171,00
●● antracite/marrone 500 / 550lm	1002953	171,00





1002955 760



ASTINA
WL, QPAR51

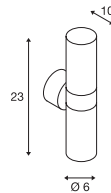

220-240V ~50/60Hz
Materiale: alluminio/vetro



Attacco: 2xGU10

L max: 9 cm

Versione	Articolo	EUR
● antracite	228775	83,00
○ bianco	228771	83,00
● alluminio	228776	88,00



LED GU10 51mm | 6W | 38°
2700K | 450lm | Classe=F
6kWh/1000h

Articolo: 1005075 | 7,50 EUR



ASTINA STEEL
WL, QPAR51

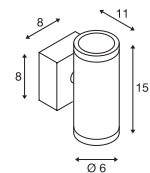

220-240V ~50/60Hz
Materiale: acciaio inox 304



Attacco: 2xGU10

Ø max: 5,1 cm

L: 5,7 cm

Versione	Articolo	EUR
● acciaio inox	233302	124,00



LED GU10 51mm | 6W | 38°
2700K | 450lm | Classe=F
6kWh/1000h

Articolo: 1005075 | 7,50 EUR



228775 761

ANGOLUX SENSOR
WL

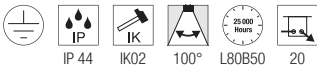
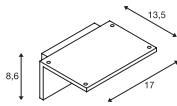

100-240V ~50/60Hz | 240mA
Potenza del sistema: 9,8W
Materiale: alluminio

- Sensore di movimento
- Classe di protezione IP44 solo in caso di montaggio con emissione verso il basso.



Down 750lm | 3000K

Versione	Articolo	EUR
● antracite	1001969	181,00
○ bianco	1001970	181,00

ANGOLUX
WL

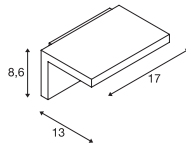

220-240V ~50/60Hz | 80mA
Potenza del sistema: 6,8W
Materiale: alluminio

- Classe di protezione IP44 solo in caso di montaggio con emissione verso il basso.



Down 550lm | 3000K

Versione	Articolo	EUR
● antracite	231355	161,00
○ bianco	231351	161,00

1001969 762



1002504 763



1002505 763





VILUA S WL

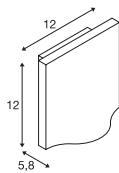

100-277V ~50/60Hz | 700mA
Potenza del sistema: 9W
Materiale: alluminio/vetro

VILUA L WL

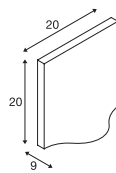

100-277V ~50/60Hz | 350mA
Potenza del sistema: 17W
Materiale: alluminio/vetro

VILUA UP/DOWN, WL

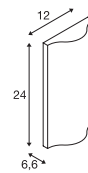

100-277V ~50/60Hz | 700mA
Potenza del sistema: 16W
Materiale: alluminio/vetro



Down 405lm | 3000K

Versione	Articolo	EUR
● antracite	1002503	157,00



Down 940lm | 3000K

Versione	Articolo	EUR
● antracite	1002504	206,00



Up 400lm | 3000K
Down 400lm | 3000K

Versione	Articolo	EUR
● antracite	1002505	206,00

MYRA UP/DOWN
WL, QPAR51

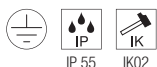
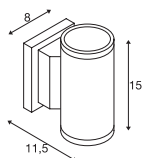

220-240V ~50/60Hz
Materiale: alluminio/vetro



Attacco: 2xGU10 Ø max: 5,1 cm L: 5,7 cm

Versione	Articolo	EUR
● antracite	233115	99,00
● grigio	233114	99,00



LED GU10 51mm | 6W | 38°
2700K | 450lm | Classe=F
6kWh/1000h



Articolo: 1005077 | 7,50 EUR



Articolo	Articolo	EUR
Telaio per posa con cablaggio a vista		
● antracite	233215	21,75
● grigio	233214	21,75



233114 764



SITRA UP/DOWN WL

SITRA UP/DOWN WL, TCR-TSE

230362 765

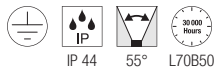
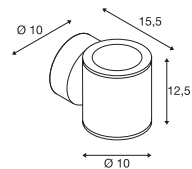
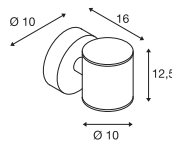

220-240V ~50/60Hz
Potenza del sistema: 18W
Materiale: alluminio/vetro



220-240V ~50/60Hz
Materiale: alluminio/vetro



Up 488lm | 3000K
Down 488lm | 3000K



Attacco: 2xGX53 | Ø max: 7,5 cm | L: 3,5 cm

Versione	Articolo	EUR
● antracite	1002018	151,00

Versione	Articolo	EUR
● antracite	230365	100,00



LED GX53 | 6,1W | 120°
3000K | 490lm | Classe=G
6kWh/1000h



Articolo: 1005271 | 11,50 EUR



1000334 767



ROX
WL, QPAR111

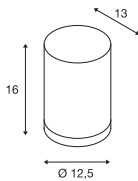

220-240V ~50/60Hz
Materiale: alluminio/vetro



Attacco: 1xGU10

Versione	Articolo	EUR
● alluminio	1000333	151,00



QPAR111 | 12,5W | 10°
3000K | 950lm | Classe=F
13kWh/1000h



Articolo: 1005278 | 55,00 EUR

ROX UP/DOWN
WL, QPAR111

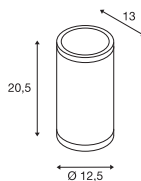

220-240V ~50/60Hz
Materiale: alluminio/vetro



Attacco: 2xGU10

Versione	Articolo	EUR
● alluminio	1000334	191,00



QPAR111 | 12,5W | 10°
3000K | 950lm | Classe=F
13kWh/1000h



Articolo: 1005278 | 55,00 EUR

DELWA
WL

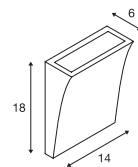

220-240V ~50/60Hz | 700mA
Potenza del sistema: 10W
Materiale: alluminio/vetro



Down

840lm | 3000K

Versione	Articolo	EUR
● antracite	1000342	212,00
○ bianco	1000340	212,00

SLOTS
WL

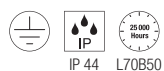
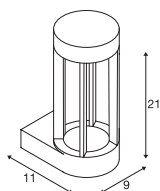

220-240V ~50/60Hz
Potenza del sistema: 4,5W
Materiale: alluminio/vetro



Down 140lm | 3000K

Versione	Articolo	EUR
● antracite	231805	171,00
● ruggine	231807	171,00

WALLYX
WL, QPAR51

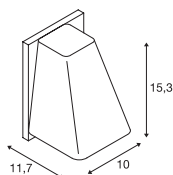

220-240V ~50/60Hz
Materiale: alluminio/vetro



Attacco: 1xGU10 L max: 7,6 cm

Versione	Articolo	EUR
● antracite	227195	119,00



LED GU10 51mm | 6W | 38°
2700K | 450lm | Classe=F
6kWh/1000h



Articolo: 1005077 | 7,50 EUR

227195 768





DOWNUNDER OUT WL, rotondo

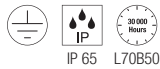
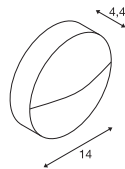

100-240V ~50/60Hz | 500mA
Potenza del sistema: 4,3W
Materiale: alluminio



Down 150lm | 3000K | 160lm | 4000K

Versione	Articolo	EUR
● antracite	1002868	134,00

DOWNUNDER OUT WL, quadrato

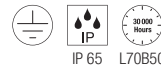
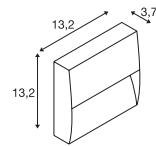

100-240V ~50/60Hz | 500mA
Potenza del sistema: 4,3W
Materiale: alluminio



Down 150lm | 3000K | 160lm | 4000K

Versione	Articolo	EUR
● antracite	1002869	134,00

1002868 769

ABRIDOR SENSOR WL

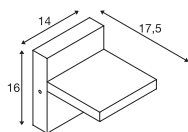

100-240V ~50/60Hz | 300mA
Potenza del sistema: 12W
Materiale: alluminio

- Sensore di movimento



Down 950lm | 3000K | 980lm | 4000K

Versione	Articolo	EUR
● antracite	1002990	201,00

ABRIDOR WL

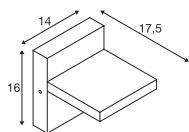

100-240V ~50/60Hz | 300mA
Potenza del sistema: 12W
Materiale: alluminio



Down 950lm | 3000K | 980lm | 4000K

Versione	Articolo	EUR
● antracite	1002989	181,00

1002990 770



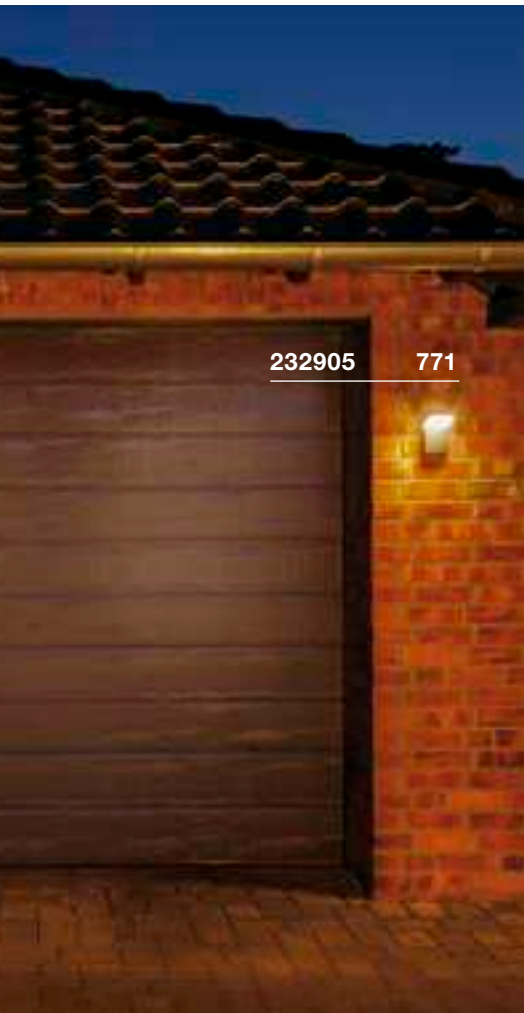

232905

771

ORDI SENSOR WL

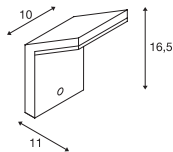

220-240V ~50/60Hz | 110mA
Potenza del sistema: 9W
Materiale: alluminio

- Sensore di movimento



Down 740lm | 3000K

Versione	Articolo	EUR
● antracite	232915	151,00

ORDI WL

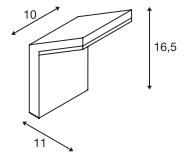

220-240V ~50/60Hz | 110mA
Potenza del sistema: 9W
Materiale: alluminio



Down 740lm | 3000K

Versione	Articolo	EUR
● antracite	232905	131,00



232495 773



1002035 773



232485 773



BOX-L
WL, E27

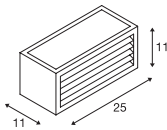

220-240V ~50/60Hz
Materiale: alluminio/acrilico



Attacco: 1xE27 Ø max: 6 cm L: 17,5 cm

Versione	Articolo	EUR
● antracite	232495	104,00
○ bianco	232491	104,00
● ruggine	232497	104,00



LED E27 | 8W | 240°
3000K | 880lm | Classe=E
8kWh/1000h



Articolo: 1005289 | 10,25 EUR

BOX-L
WL

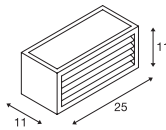

100-277V ~50/60Hz | 500mA
Potenza del sistema: 19W
Materiale: alluminio/acrilico



Down 600lm | 3000K

Versione	Articolo	EUR
● antracite	1002035	128,00

BOX UP/DOWN
WL, QT-DE12

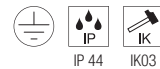
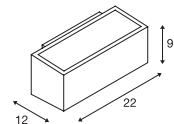

220-240V ~50/60Hz
Materiale: alluminio



Attacco: 1xR7s 78mm

Versione	Articolo	EUR
● antracite	232485	100,00



LED R7s | 9W | 330°
3000K | 1050lm | Classe=E
9kWh/1000h



Articolo: 1005287 | 24,00 EUR



232101 775



1003539 775



LOGS
WL

OUT-BEAM UP /
FLOOD DOWN
WL

L-LINE OUT
WL

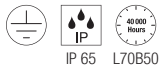
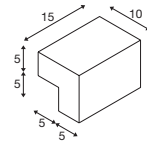
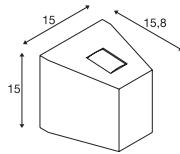
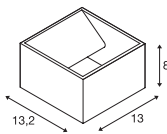

220-240V ~50/60Hz | 500mA
Potenza del sistema: 9,5W
Materiale: alluminio

220-240V ~50/60Hz | 500mA
Potenza del sistema: 18W
Materiale: alluminio/vetro

220-240V ~50/60Hz | 350mA
Potenza del sistema: 7W
Materiale: alluminio/policarbonato (PC)



Down 520lm | 3000K
800lm

Up 50lm | 3000K
Down 690lm | 3000K

Down 500lm | 3000K | 570lm | 4000K

Versione	Articolo	EUR
● antracite		
520lm	232105	200,00
○ bianco		
800lm	232101	200,00

Versione	Articolo	EUR
● antracite	229665	274,00
● grigio	229664	274,00

Versione	Articolo	EUR
● antracite	1003539	141,00

232045 777





PHOTONIA
WL, E27

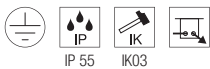
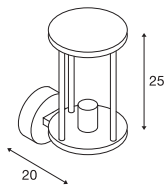

220-240V ~50/60Hz
Materiale: alluminio/vetro



Attacco: 1xE27 Ø max: 9 cm L: 15 cm

Versione	Articolo	EUR
● antracite	232045	189,00



LED E27 | 7,5W | 320°
2500K | 700lm | Classe=F
8kWh/1000h



Articolo: 1005265 | 26,50 EUR



Articolo	Articolo	EUR
Set distanziatori		
● antracite	1002853	7,75

MOLAT
WL, E27

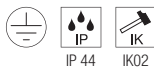
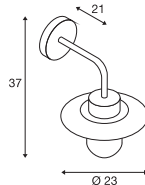

220-240V ~50/60Hz
Materiale: alluminio/vetro



Attacco: 1xE27 Ø max: 6,5 cm L: 14,5 cm

Versione	Articolo	EUR
● antracite	1000820	106,00



A60 | 7,5W | 320°
2700K | 800lm | Classe=F
8kWh/1000h



Articolo: 1005303 | 9,60 EUR

GLOO PURE
WL, E27

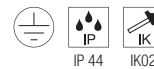
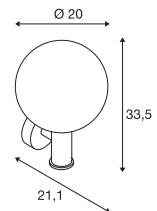

220-240V ~50/60Hz
Materiale: alluminio/vetro



Attacco: 1xE27 Ø max: 4,8 cm L: 18 cm

Versione	Articolo	EUR
● antracite	1002002	97,00



LED E27 | 8W | 240°
4000K | 920lm | Classe=E
8kWh/1000h



Articolo: 1005290 | 10,25 EUR



1000336 779

F-POL
WL, E27

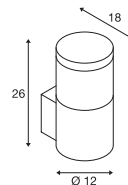

230355 779

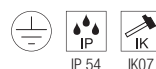

220-240V ~50/60Hz
Materiale: alluminio/policarbonato (PC)



Attacco: 1xE27 Ø max: 5,1 cm L: 14 cm

Versione	Articolo	EUR
● antracite	231585	141,00



LED E27 | 8W | 240°
4000K | 920lm | Classe=E
8kWh/1000h



Articolo: 1005290 | 10,25 EUR



SQUARE WL, E27

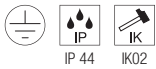
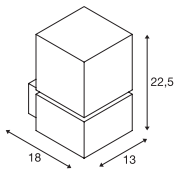

220-240V ~50/60Hz
Materiale: acciaio inox 304



Attacco: 1xE27 Ø max: 7 cm L: 13 cm

Versione	Articolo	EUR
● acciaio inox	1000336	224,00



A60 | 7,5W | 320°
2700K | 800lm | Classe=F
8kWh/1000h



Articolo: 1005303 | 9,60 EUR

KERAS ELT WL, E27

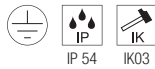
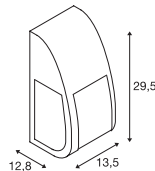

220-240V ~50/60Hz
Materiale: alluminio/polycarbonato (PC)



Attacco: 1xE27 Ø max: 7 cm L: 17,5 cm

Versione	Articolo	EUR
● antracite	227176	162,00



A60 | 7,5W | 320°
2700K | 800lm | Classe=F
8kWh/1000h



Articolo: 1005303 | 9,60 EUR

SITRA WL, TCR-TSE

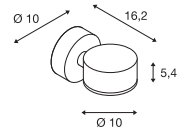

220-240V ~50/60Hz
Materiale: alluminio/vetro



Attacco: 1xGX53 Ø max: 7,5 cm L: 3,5 cm

Versione	Articolo	EUR
● antracite	230355	70,00



LED GX53 | 6,1W | 120°
3000K | 490lm | Classe=G
6kWh/1000h



Articolo: 1005271 | 11,50 EUR

RASCALI
WL

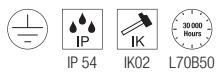
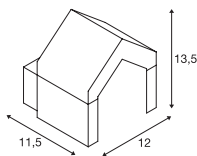

220-240V ~50/60Hz
Potenza del sistema: 8W
Materiale: alluminio



Down 330lm | 3000K

Versione	Articolo	EUR
● antracite	1000797	133,00

IPERI
WL

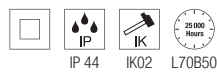
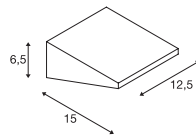

220-240V ~50/60Hz
Potenza del sistema: 4,5W
Materiale: alluminio

- Classe di protezione IP44 solo in caso di montaggio con emissione verso il basso.



Down 400lm | 4000K

Versione	Articolo	EUR
● nero	231315	129,00

1000797 780





QUADRASYL WL, TCR-TSE

SQUARE TURN WL, G9

231315 781

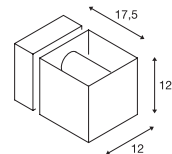
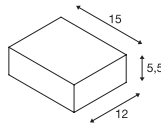

IP 44

220-240V ~50/60Hz
Materiale: alluminio/vetro

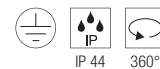

IP 44

360°

220-240V ~50/60Hz
Materiale: alluminio/vetro



Attacco: 1xGX53 Ø max: 7,5 cm L: 2,7 cm

Versione	Articolo	EUR
● antracite	232285	64,00



LED GX53 | 6,1W | 120°
3000K | 490lm | Classe=G
6kWh/1000h



Articolo: 1005271 | 11,50 EUR



Attacco: 1xG9 Ø max: 3,5 cm L: 8 cm

Versione	Articolo	EUR
● grigio	1000335	211,00



LED G9 | 3,6W | 300°
3000K | 400lm | Classe=E
4kWh/1000h



Articolo: 1005286 | 9,99 EUR

1000335 781

1002905 783



233134 783





TODAY PRO Display

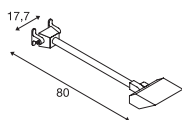

220-240V ~50/60Hz | 640mA
Potenza del sistema: 29W
Materiale: alluminio



Down 2800lm | 4000K

Versione	Articolo	EUR
● nero	1000880	228,00
○ bianco	1000881	228,00

ESKINA D Display, PHASE

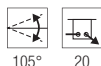
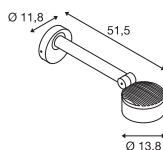

220-240V ~50/60Hz | 350mA
Potenza del sistema: 14,5W
Materiale: alluminio

- Interruttore CCT nel vano ottico



Down 1000lm | 3000K | 1000lm | 4000K

Versione	Articolo	EUR
● antracite	1002905	272,00

MYRA DISPLAY WL, curved, QPAR51

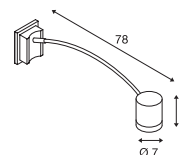

220-240V ~50/60Hz
Materiale: alluminio



Attacco: 1xGU10 Ø max: 5,1 cm | L: 5,7 cm

Versione	Articolo	EUR
● antracite	233135	179,00
● grigio	233134	179,00



LED GU10 51mm | 6W | 38°
2700K | 450lm | Classe=F
6kWh/1000h



Articolo: 1005077 | 7,50 EUR



Articolo	Articolo	EUR
Telaio per posa con cablaggio a vista		
● antracite	233215	21,75
● grigio	233214	21,75



1004649 785

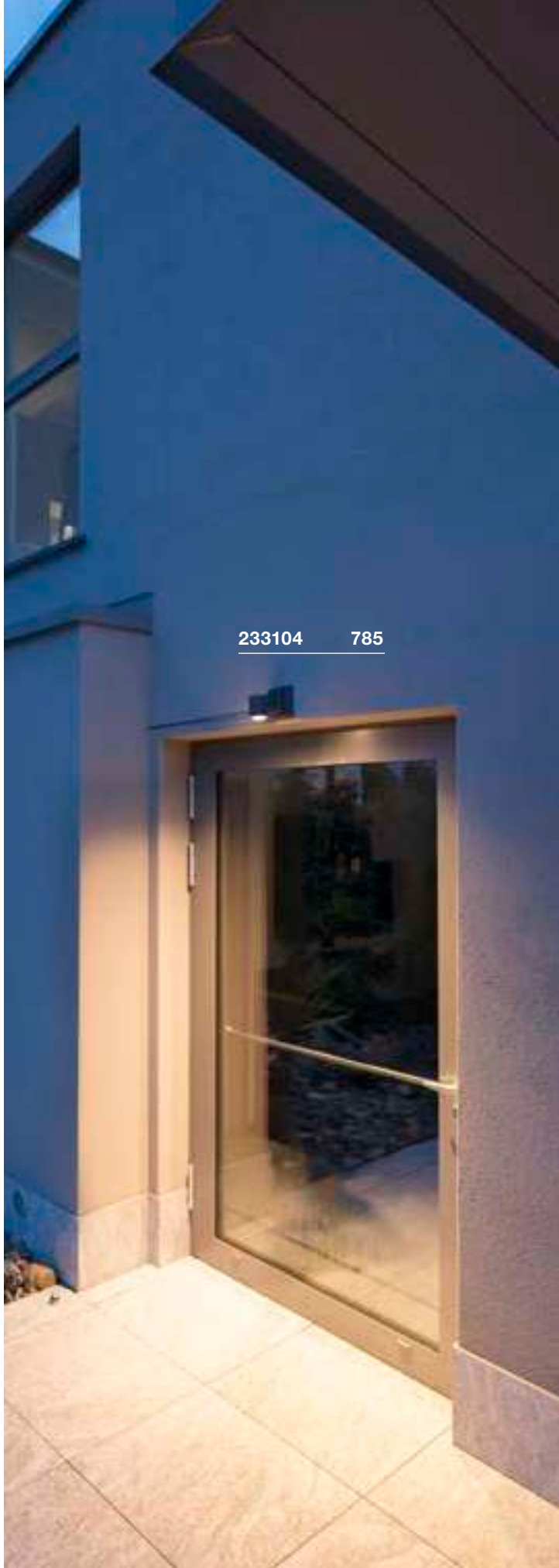

233104 785



LED SPOT SP

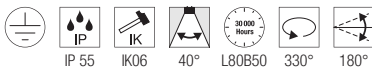
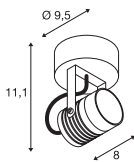

100-240V ~50/60Hz | 240mA
Potenza del sistema: 6W
Materiale: alluminio/vetro



Down 400lm | 3000K

Versione	Articolo	EUR
● antracite	1004649	72,00
● ruggine	1004957	72,00

NAUTILUS WL QPAR51

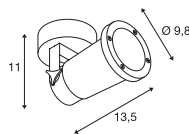

220-240V ~50/60Hz
Materiale: alluminio



Attacco: 1xGU10 Ø max: 5,1 cm L: 8,3 cm

Versione	Articolo	EUR
● nero	1002867	49,00



LED GU10 51mm | 6W | 38°
2700K | 450lm | Classe=F
6kWh/1000h

Articolo: 1005077 | 7,50 EUR



Articolo	Articolo	EUR
Telaio per posa con cablaggio a vista		
● nero	1002884	5,40

MYRA CW, single, QPAR51

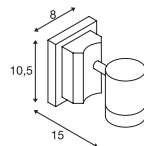

220-240V ~50/60Hz
Materiale: alluminio/vetro



Attacco: 1xGU10 Ø max: 5,1 cm L: 5,7 cm

Versione	Articolo	EUR
● antracite	233105	89,00
● grigio	233104	89,00



LED GU10 51mm | 6W | 38°
2700K | 450lm | Classe=F
6kWh/1000h

Articolo: 1005077 | 7,50 EUR



Articolo	Articolo	EUR
Telaio per posa con cablaggio a vista		
● antracite	233215	21,75
● grigio	233214	21,75

1003427 793

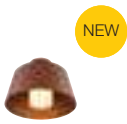

**SCKET**

PHOTONI | 789

**LED**

S-CUBE | 791

**LED**

ESKINA FRAME | 791

**LED**ENOLA
OCULUS | 792**LED**ENOLA
ROUND S | 793**LED**ENOLA
ROUND M | 793**LED**ENOLA
ROUND L | 793**LED**ENOLA
SQUARE S | 795**LED**ENOLA
SQUARE M | 795**LED**ENOLA S
QUARE L | 795**LED**

BIG THEO | 797

**SCKET**

BIG THEO | 797

**LED**

OVALISK | 797

**SCKET**

PHOTONIA | 799

**SCKET**

MOLAT | 799

**SCKET**

SITRA | 801

**SCKET**

ROX | 801

**SCKET**

ROX | 801

1007586 789





PHOTONI CL, E27

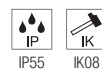
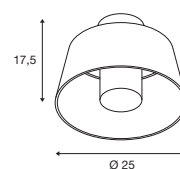

220-240V ~50/60Hz
Materiale: alluminio

- Resistente all'aria marina

**SOCKET
INSIDE** 13
W

Attacco: 1xE27 Ø max: 6 cm L: 11,6 cm

Versione	Articolo	EUR
● nero	1007586	99,00
● ruggine	1007582	99,00



LED E27 | 8W | 240°
3000K | 880lm | Classe=E
8kWh/1000h



Articolo: 1005289 | 10,25 EUR

1007461 791

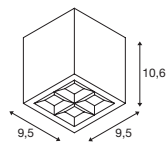

S-CUBE
CL

220-240V ~50/60Hz | 350mA
Potenza del sistema: 15W
Materiale: alluminio



Down 1000lm | 2700K | 1200lm | 3000K

Versione	Articolo	EUR
● antracite	1007461	● 134,00

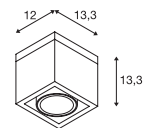
ESKINA FRAME
CL, single

220-240V ~50/60Hz | 350mA
Potenza del sistema: 15W
Materiale: alluminio/vetro



Down 1100lm | 3000K | 1200lm | 4000K

Versione	Articolo	EUR
● antracite	1006316	183,00

ENOLA OCULUS CL

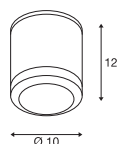

220-240V ~50/60Hz | 500mA
Potenza del sistema: 11W
Materiale: alluminio/vetro



Down 1000lm | 3000K | 1100lm | 4000K

Versione	Articolo	EUR
● antracite	1006327	239,00



Articolo	Articolo	EUR
Set distanziatori		
● antracite	1003479	9,05

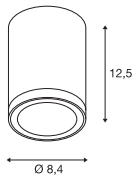

1006327 792

ENOLA ROUND S
CL

220-240V ~50/60Hz | 500mA
Potenza del sistema: 9W
Materiale: alluminio/vetro



Down 540lm | 3000K | 610lm | 4000K

Versione	Articolo	EUR
● antracite	1003426	172,00

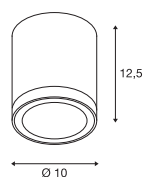

Articolo	Articolo	EUR
Set distanziatori		
● antracite	1003479	9,05
Riflettore 60°		
● cromo	1005262	16,40

ENOLA ROUND M
CL

220-240V ~50/60Hz | 500mA
Potenza del sistema: 11W
Materiale: alluminio/vetro



Down 840lm | 3000K | 960lm | 4000K

Versione	Articolo	EUR
● antracite	1003427	219,00

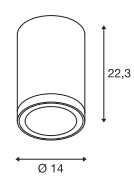

Articolo	Articolo	EUR
Set distanziatori		
● antracite	1003479	9,05
Lente da 19°		
● nero	1005205	41,75
Lente asimmetrica		
● nero/cromo	1005206	41,75
Riflettore 60°		
● cromo	1005207	24,75

ENOLA ROUND L
CL

220-240V ~50/60Hz | 900mA
Potenza del sistema: 36W
Materiale: alluminio/vetro



Down 3200lm | 3000K | 3500lm | 4000K

Versione	Articolo	EUR
● antracite	1003442	312,00



Articolo	Articolo	EUR
Set distanziatori		
● antracite	1003479	9,05
Riflettore 60°		
● cromo	1005263	21,50

1003421 795

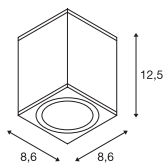

ENOLA SQUARE S
CL

220-240V ~50/60Hz | 500mA
Potenza del sistema: 9W
Materiale: alluminio/vetro



Down 540lm | 3000K | 610lm | 4000K

Versione	Articolo	EUR
● antracite	1003420	172,00

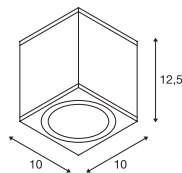

Articolo	Articolo	EUR
Set distanziatori		
● antracite	1003479	9,05
Riflettore 60°		
● cromo	1005262	16,40

ENOLA SQUARE M
CL

220-240V ~50/60Hz | 500mA
Potenza del sistema: 11W
Materiale: alluminio/vetro



Down 840lm | 3000K | 960lm | 4000K

Versione	Articolo	EUR
● antracite	1003421	219,00

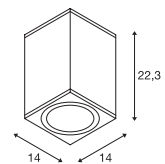

Articolo	Articolo	EUR
Set distanziatori		
● antracite	1003479	9,05
Lente da 19°		
● nero	1005205	41,75
Lente asimmetrica		
● nero/cromo	1005206	41,75
Riflettore 60°		
● cromo	1005207	24,75

ENOLA SQUARE L
CL

220-240V ~50/60Hz | 900mA
Potenza del sistema: 36W
Materiale: alluminio/vetro



Down 3200lm | 3000K | 3500lm | 4000K

Versione	Articolo	EUR
● antracite	1003439	312,00



Articolo	Articolo	EUR
Set distanziatori		
● antracite	1003479	9,05
Riflettore 60°		
● cromo	1005263	21,50



234535 797

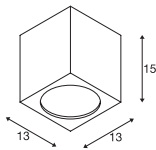

1004677 797

BIG THEO
CL

100-277V ~50/60Hz | 500mA
Potenza del sistema: 21W
Materiale: alluminio/vetro



Down 2000lm | 3000K

Versione	Articolo	EUR
● antracite	234535	209,00

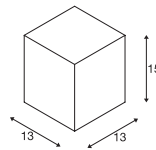
BIG THEO
CL, QPAR111

220-240V ~50/60Hz
Materiale: alluminio/vetro



Attacco: 1xGU10

Versione	Articolo	EUR
● antracite	229555	124,00
○ bianco	229551	124,00
● grigio	229554	124,00



QPAR111 | 12,5W | 10°
3000K | 950lm | Classe=F
13kWh/1000h

Articolo: 1005278 | 55,00 EUR

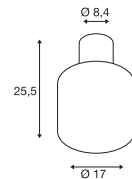
OVALISK
CL

220-240V ~50/60Hz | 350mA
Potenza del sistema: 7,9W
Materiale: alluminio/vetro



Down 540lm | 3000K | 570lm | 4000K

Versione	Articolo	EUR
● antracite	1004677	272,00

232055 799

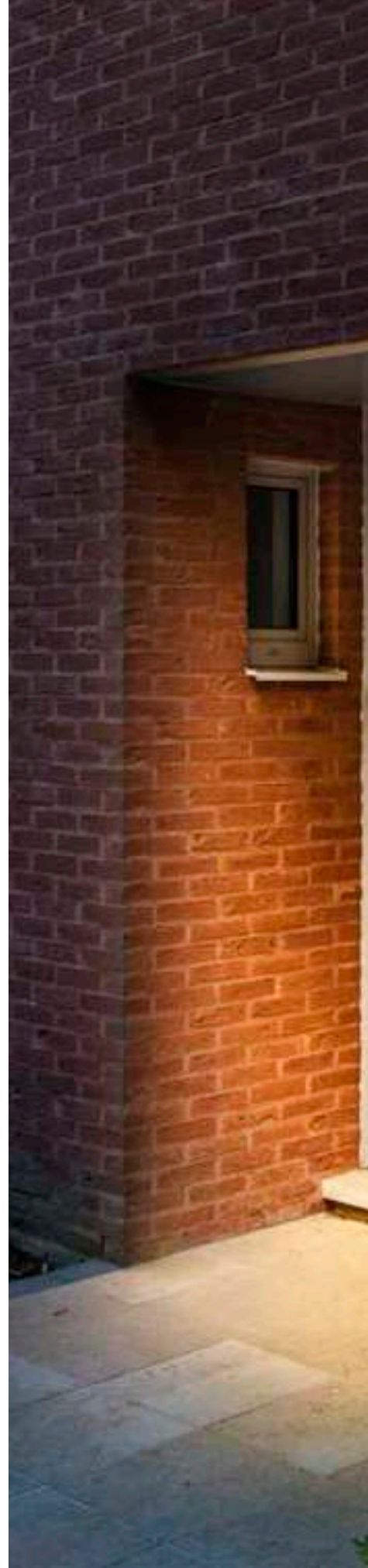



PHOTONIA CL, E27

MOLAT CL, E27

1000823 799

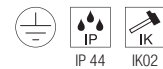
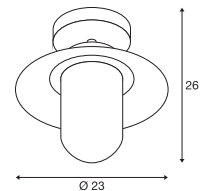
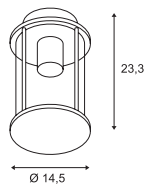

220-240V ~50/60Hz
Materiale: alluminio/vetro

220-240V ~50/60Hz
Materiale: alluminio/vetro

SOCKET INSIDE <60 W

SOCKET INSIDE <60 W

Attacco: 1xE27 Ø max: 9 cm L: 15 cm

Attacco: 1xE27 Ø max: 6,5 cm L: 14,5 cm

Versione	Articolo	EUR
● antracite	232055	206,00

Versione	Articolo	EUR
● antracite	1000823	132,00



LED E27 | 7,5W | 320°
2500K | 700lm | Classe=F
8kWh/1000h



Articolo: 1005265 | 26,50 EUR



LED E27 | 7,5W | 320°
2500K | 700lm | Classe=F
8kWh/1000h



Articolo: 1005265 | 26,50 EUR



Articolo	Articolo	EUR
Set distanziatori		
● antracite	1002853	7,75

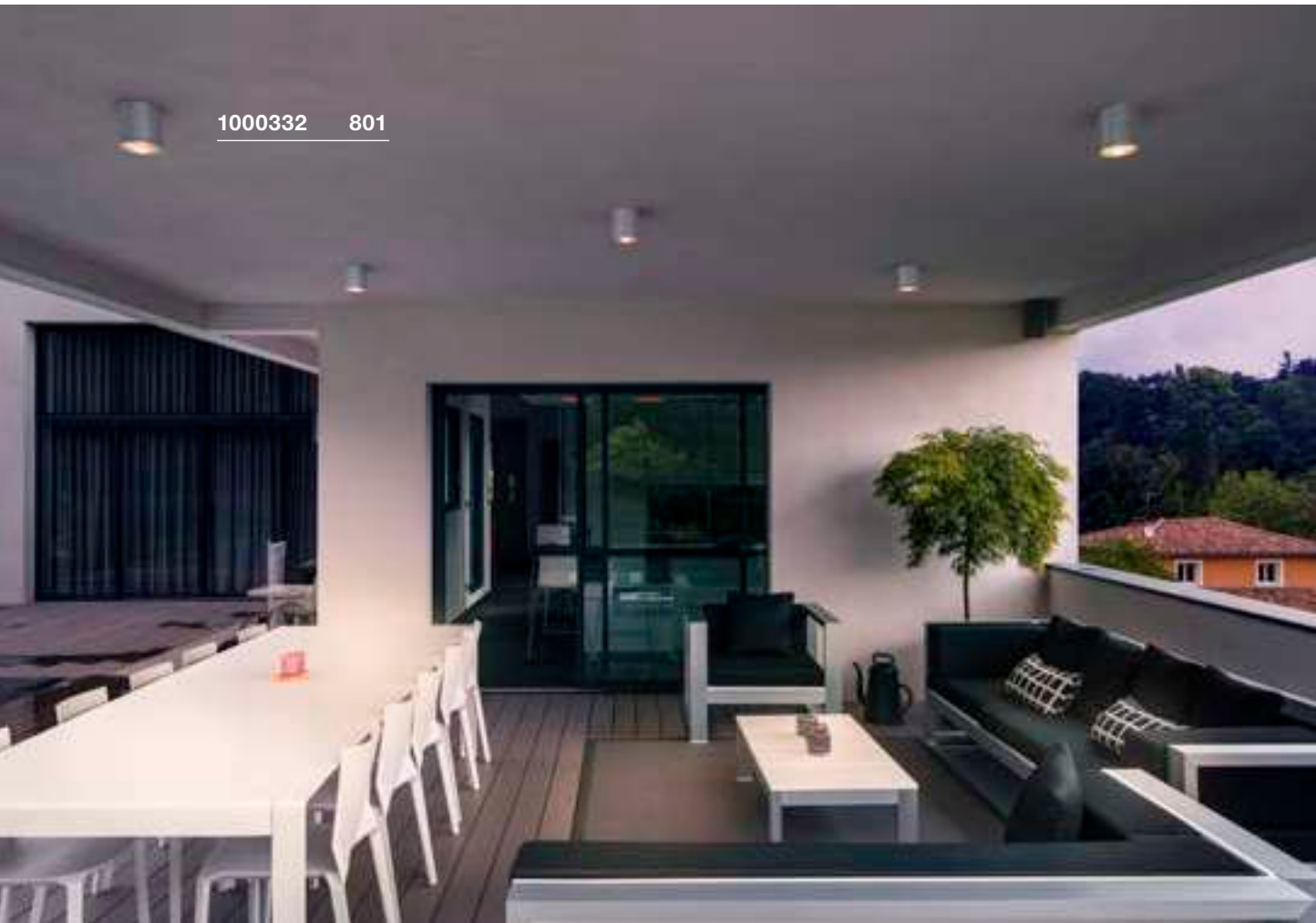

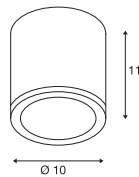
SITRA
CL, TCR-TSE

IP 44

220-240V ~50/60Hz
Materiale: alluminio/vetro

Attacco: 1xGX53 Ø max: 7,5 cm L: 3,5 cm

Versione	Articolo	EUR
● antracite	231545	90,00
○ bianco	231541	90,00

LED GX53 | 6,1W | 120°
3000K | 490lm | Classe=G
6kWh/1000h

Articolo: 1005271 | 11,50 EUR

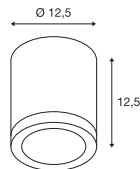
ROX
CL, QPAR111

IP 44

220-240V ~50/60Hz
Materiale: alluminio/vetro

Attacco: 1xGU10

Versione	Articolo	EUR
● alluminio	1000332	131,00

QPAR111 | 12,5W | 10°
3000K | 950lm | Classe=F
13kWh/1000h

Articolo: 1005278 | 55,00 EUR

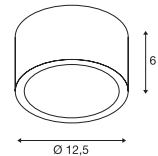
ROX
CL, GX53

IP 44

220-240V ~50/60Hz
Materiale: alluminio/vetro

Attacco: 1xGX53 Ø max: 7,5 cm L: 3,5 cm

Versione	Articolo	EUR
● alluminio/trasparente	1000339	161,00

LED GX53 | 6,1W | 120°
3000K | 490lm | Classe=G
6kWh/1000h

Articolo: 1005271 | 11,50 EUR

1005202 811





LED
R-CUBE | 805



LED
S-CUBE | 805



S-CCKET
S-TUBE | 805



LED
ESKINA SPOT
SENSOR | 807



LED
ESKINA SPOT | 807



S-CCKET
SITRA 360 | 808



S-CCKET
THEO BRACKET | 808



LED
HELIA | 809



LED
HELIA | 809



S-CCKET
MYRA | 811



LED
OUT-BEAM
FRAME | 811



LED
QUADRULO | 811



LED
AINOS | 812-813



LED
AINOS | 813



LED
AINOS | 813



LED
RUBA | 814



S-CCKET
BULAN | 815



S-CCKET
BULAN GRID | 815



LED
TERANG 200 | 817



LED
IMPERVA | 817



1007511 805



1007653 805



R-CUBE CW

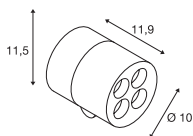

220-240V ~50/60Hz | 350mA
Potenza del sistema: 15W
Materiale: alluminio



Down 800lm | 2700K | 800lm | 3000K

Versione	Articolo	EUR
● antracite	1007511	● 154,00

S-CUBE CW

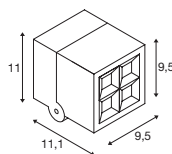

220-240V ~50/60Hz | 350mA
Potenza del sistema: 15W
Materiale: alluminio



Down 1000lm | 2700K | 1200lm | 3000K

Versione	Articolo	EUR
● antracite	1007458	● 154,00

S-TUBE CW

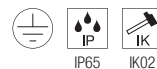
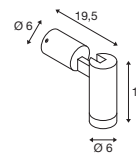

220-240V ~50/60Hz
Materiale: alluminio



Attacco: 1xGU10 Ø max: 5 cm L: 5,5 cm

Versione	Articolo	EUR
● nero	1007653	● 99,00



LED GU10 51mm | 6W | 38°
2700K | 450lm | Classe=F
6kWh/1000h



Articolo: 1005077 | 7,50 EUR

1002904 807

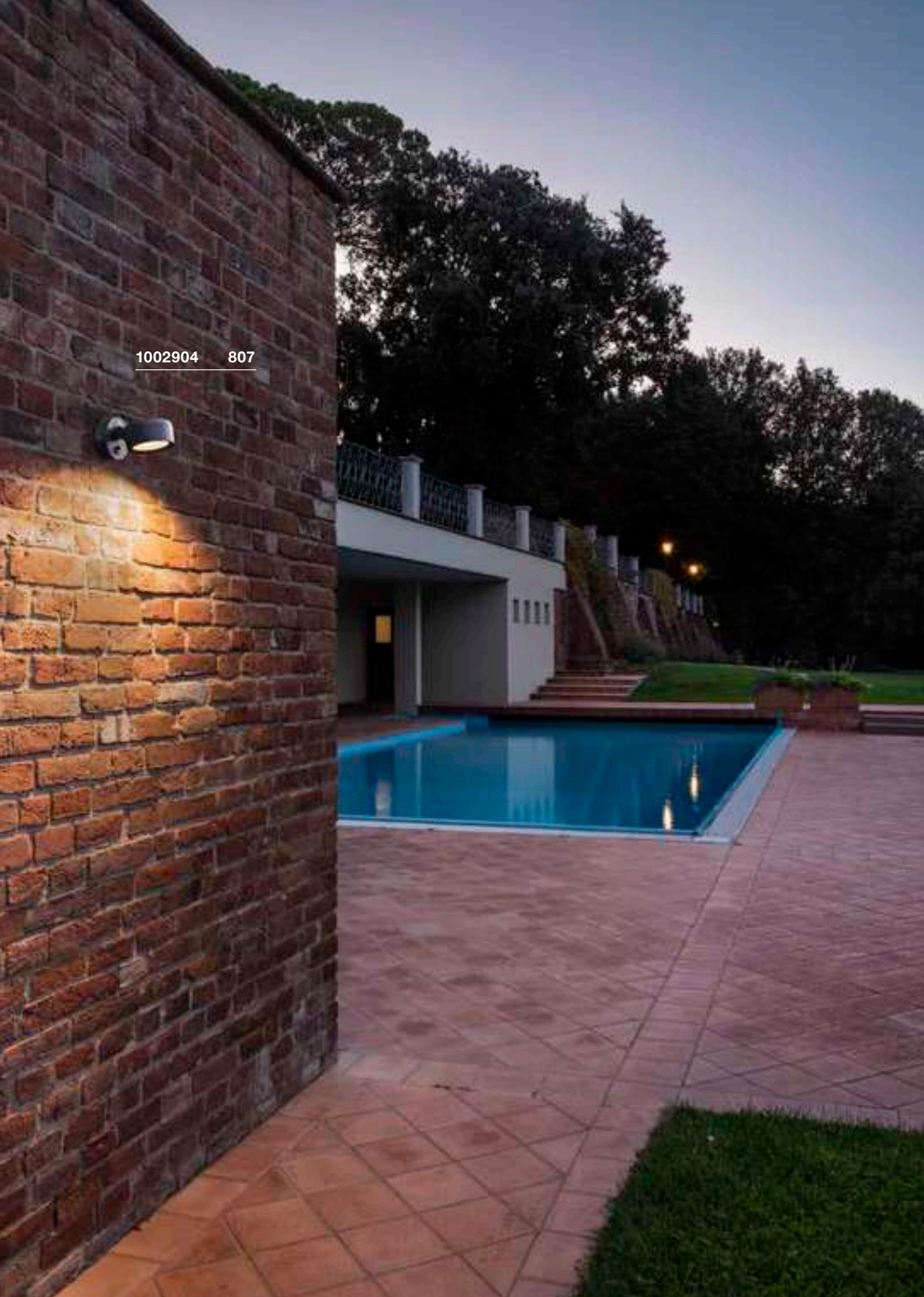



ESKINA SPOT SENSOR CW, PHASE

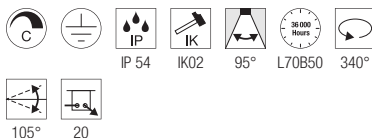
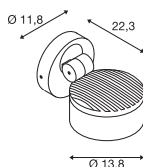

220-240V ~50/60Hz | 350mA
Potenza del sistema: 15W
Materiale: alluminio

- Sensore di movimento



Down 1000lm | 3000K | 1000lm | 4000K

Versione	Articolo	EUR
● antracite	1002904	272,00

ESKINA SPOT CW, PHASE

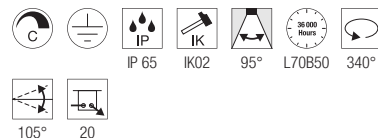
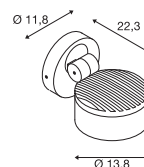

220-240V ~50/60Hz | 350mA
Potenza del sistema: 14,5W
Materiale: alluminio



Down 1000lm | 3000K | 1000lm | 4000K

Versione	Articolo	EUR
● antracite	1002903	252,00

SITRA 360
CW, TCR-TSE

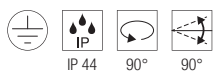
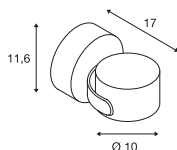

220-240V ~50/60Hz
Materiale: alluminio/vetro



Attacco: 1xGX53 Ø max: 7,5 cm L: 3,5 cm

Versione	Articolo	EUR
● antracite	231515	109,00



LED GX53 | 6,1W | 120°
3000K | 490lm | Classe=G
6kWh/1000h



Articolo: 1005271 | 11,50 EUR

THEO BRACKET
CW

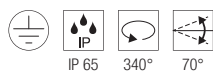
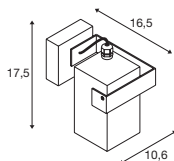

220-240V ~50/60Hz
Materiale: alluminio/vetro



Attacco: 1xGU10 Ø max: 5,1 cm L: 5,7 cm

Versione	Articolo	EUR
● antracite	1004653	77,00



LED GU10 51mm | 6W | 38°
2700K | 450lm | Classe=F
6kWh/1000h



Articolo: 1005077 | 7,50 EUR



233245 809

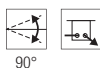
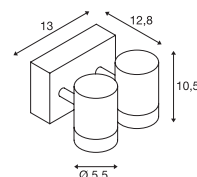
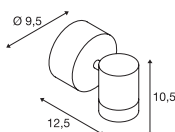

1004653 808

HELIA
CW, single, PHASE**HELIA**
CW, double, PHASE220-240V ~50/60Hz | 500mA
Potenza del sistema: 6,5W
Materiale: alluminio/vetro

Down 440lm | 3000K

Versione	Articolo	EUR
● antracite	233245	176,00

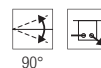
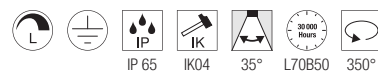

Articolo	Articolo	EUR
Set distanziatori		
● antracite	1002853	7,75

220-240V ~50/60Hz | 500mA
Potenza del sistema: 13W
Materiale: alluminio/vetro

Down 880lm | 3000K

Versione	Articolo	EUR
● antracite	233255	309,00



Articolo	Articolo	EUR
Set distanziatori		
● antracite	1002853	7,75

1003519 811



1005202 811





MYRA

WL, double, QPAR51

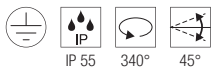
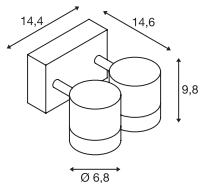

220-240V ~50/60Hz
Materiale: alluminio/vetro



Attacco: 2xGU10 Ø max: 5,1 cm L: 5,7 cm

Versione	Articolo	EUR
● antracite	233095	169,00
● grigio	233094	169,00



LED GU10 51mm | 6W | 38°
2700K | 450lm | Classe=F
6kWh/1000h



Articolo: 1005077 | 7,50 EUR



Articolo	Articolo	EUR
Set distanziatori		
● antracite	1002853	7,75

OUT-BEAM FRAME

SP

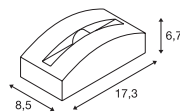

100-240V ~50/60Hz | 700mA
Potenza del sistema: 3,5W
Materiale: alluminio/acrilico



Down 60lm | 3000K

Versione	Articolo	EUR
● antracite	1003518	122,00
○ bianco	1003519	122,00

QUADRULO

CL

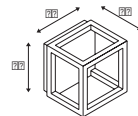

100-277V ~50/60Hz | 480mA
Potenza del sistema: 7,5W
Materiale: alluminio/acrilico



Down 230lm | 3000K

Versione	Articolo	EUR
● antracite	1005202	166,00



229971 813

AINOS CW

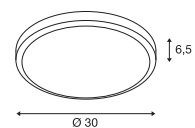

1003452 813

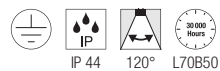

220-240V ~50/60Hz | 500mA
Potenza del sistema: 21W
Materiale: alluminio/policarbonato (PC)



Down

1430lm | 3000K

Versione	Articolo	EUR
● antracite	229965	149,00
○ bianco	229961	149,00

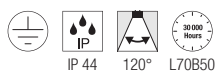
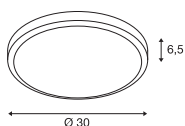
AINOS
CW SENSOR

220-240V ~50/60Hz | 500mA
Potenza del sistema: 22W
Materiale: alluminio/policarbonato (PC)

- Sensore di movimento



Down 1430lm | 3000K

Versione	Articolo	EUR
● antracite	229975	195,00
○ bianco	229971	195,00

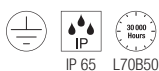
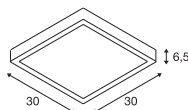
AINOS
CW, quadrato

220-240V ~50/60Hz | 500mA
Potenza del sistema: 17W
Materiale: alluminio/policarbonato (PC)

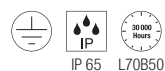
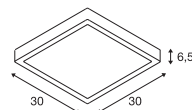
AINOS
CW SENSOR, quadrato

220-240V ~50/60Hz | 500mA
Potenza del sistema: 18W
Materiale: alluminio/policarbonato (PC)

- Sensore di movimento



Down 1300lm | 3000K | 1300lm | 4000K

Versione	Articolo	EUR
● antracite	1003452	201,00
○ bianco	1003451	201,00

RUBA CW

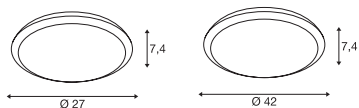

220-240V ~50/60Hz | 600mA
Potenza del sistema: 22W
Materiale: policarbonato (PC)



Down	960lm 2000lm	3000K	1100lm 2300lm	4000K
------	-----------------	-------	------------------	-------

Versione	Articolo	EUR
○ bianco Ø: 27cm 960 / 1100lm 12W	1005089	111,00
○ bianco Ø: 42cm 2000 / 2300lm 22W	1005090	222,00



229071

814

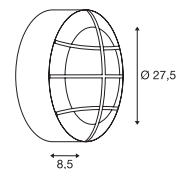
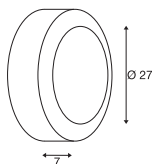

**BULAN**
CW, E14**BULAN GRID**
CW, E27

IP 44

220-240V ~50/60Hz
Materiale: alluminio/vetro

IP 55

220-240V ~50/60Hz
Materiale: alluminio/policarbonato (PC)**229085 815**

Attacco: 1xE14 Ø max: 4,8 cm L: 13 cm

Versione	Articolo	EUR
● antracite	229075	66,00
○ bianco	229071	66,00
● grigio	229072	66,00



Attacco: 2xE27 Ø max: 5,2 cm L: 17,3 cm

Versione	Articolo	EUR
● antracite	229085	70,00
○ bianco	229081	70,00

C35 | 4,2W | 320°
2700K | 350lm | Classe=G
5kWh/1000h

Articolo: 1005285 | 8,50 EUR

| 13,5W | 240°
4000K | 1600lm | Classe=E
14kWh/1000h

Articolo: 1005308 | 12,50 EUR



229935 817



TERANG 200 CW

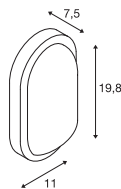

220-240V ~50/60Hz
Potenza del sistema: 11W
Materiale: alluminio/policarbonato (PC)



Down 830lm | 3000K

Versione	Articolo	EUR
● antracite	229935	80,00
○ bianco	229931	80,00

IMPERVA 120 CW

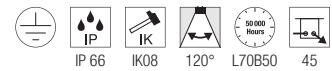
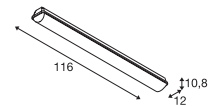

220-240V ~50/60Hz | 700mA
Potenza del sistema: 40W
Materiale: policarbonato (PC)



Down 4600lm | 3000K

Versione	Articolo	EUR
● grigio	1001314	110,00



233605 823



SCKET

CONCRETO | 821



LED

CONCRETO | 821



LED

ADI | 822



LED

DOWNUNDER
OUT S | 823



LED

DOWNUNDER
OUT M | 823



LED

DOWNUNDER
OUT L | 823



LED

BRICK MESH | 825



LED

BRICK | 825



LED

BRICK | 825



SCKET

BRICK
DOWNUNDER | 827



LED

BRICK
DOWNUNDER | 827



1006406 821



1006407 821



CONCRETO EL, Wing

CONCRETO EL, Cut

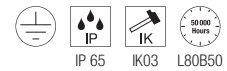
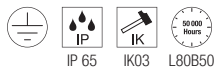
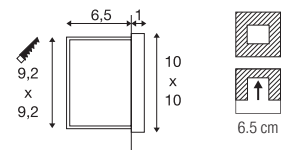
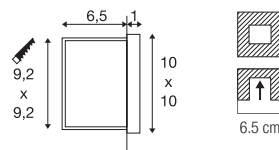

100-240V ~50/60Hz | 700mA
Potenza del sistema: 3,2W
Materiale: calcestruzzo/alluminio

100-240V ~50/60Hz | 700mA
Potenza del sistema: 3,2W
Materiale: calcestruzzo/alluminio

- Montare l'apparecchio esclusivamente con emissione verso il basso
- Scatola da incasso inclusa

- Montare l'apparecchio esclusivamente con emissione verso il basso
- Scatola da incasso inclusa



Down 45lm | 3000K

Down 15lm | 3000K

Versione	Articolo	EUR
● grigio	1006406 ●	98,00

Versione	Articolo	EUR
● grigio	1006407 ●	98,00

ADI
EL

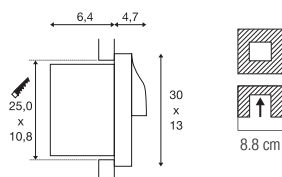

100-277V ~50/60Hz | 500mA
Potenza del sistema: 18W
Materiale: alluminio/polycarbonato (PC)

- Montare l'apparecchio esclusivamente con emissione verso il basso
- La scatola da incasso deve essere ordinata separatamente



Down 940lm | 3000K

Versione	Articolo	EUR
● antracite	233635	262,00



Articolo	Articolo	EUR
Scatola da incasso		
● nero	233639	19,70





DOWNUNDER OUT S EL

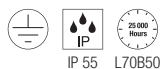
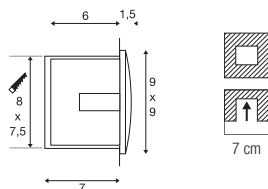

220-240V ~50/60Hz | 300mA
Potenza del sistema: 1,7W
Materiale: alluminio/plastica

- Montare l'apparecchio esclusivamente con emissione verso il basso.
- Scatola da incasso inclusa



Down 25lm | 3000K
65lm

Versione	Articolo	EUR
● antracite		
25lm	233605	63,00
○ bianco		
65lm	233601	63,00

DOWNUNDER OUT M EL

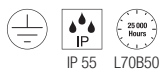
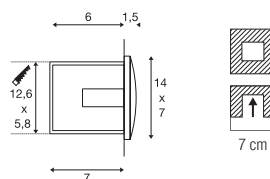

220-240V ~50/60Hz | 300mA
Potenza del sistema: 4W
Materiale: alluminio/plastica

- Montare l'apparecchio esclusivamente con emissione verso il basso.
- Scatola da incasso inclusa



Down 85lm | 3000K
155lm

Versione	Articolo	EUR
● antracite		
85lm	233625	75,00
○ bianco		
155lm	233621	75,00

DOWNUNDER OUT L EL

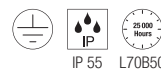
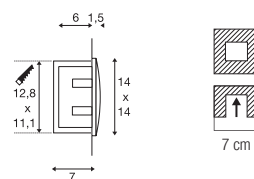

220-240V ~50/60Hz | 300mA
Potenza del sistema: 4W
Materiale: alluminio/plastica

- Montare l'apparecchio esclusivamente con emissione verso il basso.
- Scatola da incasso inclusa



Down 85lm | 3000K

Versione	Articolo	EUR
● antracite	233615	89,00



233650

825



233660

825

BRICK MESH EL

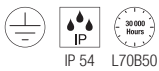
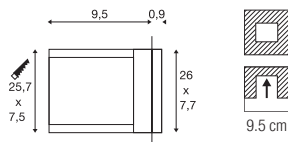
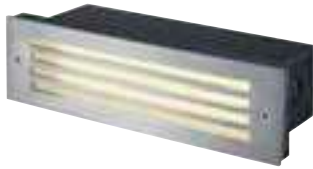

100-240V ~50/60Hz | 24V
Potenza del sistema: 3,3W
Materiale: acciaio inox 316/vetro

- Scatola da incasso inclusa



Down 52lm | 3000K

Versione	Articolo	EUR
● acciaio inox	229110	248,00

BRICK EL, simmetrico

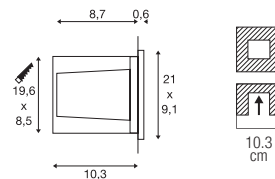

220-240V ~50/60Hz | 144mA
Potenza del sistema: 9,5W
Materiale: alluminio/acciaio inox 316

- Scatola da incasso inclusa



Down 950lm | 3000K

Versione	Articolo	EUR
● acciaio inox	233650	303,00

BRICK EL, asimmetrico

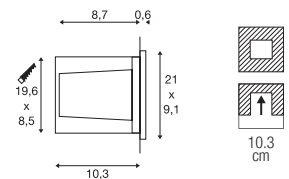

220-240V ~50/60Hz | 144mA
Potenza del sistema: 9,5W
Materiale: alluminio/acciaio inox 316

- Scatola da incasso inclusa



Down 850lm | 3000K

Versione	Articolo	EUR
● acciaio inox	233660	303,00



229062 827



BRICK DOWNUNDER EL, E14

BRICK DOWNUNDER EL

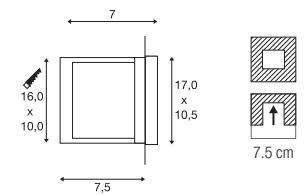
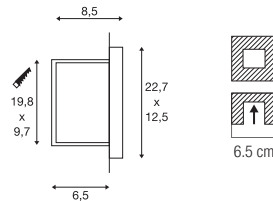

220-240V ~50/60Hz
Materiale: alluminio/vetro

- Scatola da incasso non necessaria

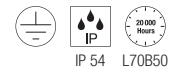

220-240V ~50/60Hz
Potenza del sistema: 1,4W
Materiale: alluminio/vetro

- Scatola da incasso inclusa



Attacco: 1xE14 Ø max: 4,3 cm L: 12 cm



Down 30lm | 3000K

Versione	Articolo	EUR
● grigio	229062	41,50

Versione	Articolo	EUR
● grigio	229702	67,00



C35 | 4,2W | 320°
2700K | 350lm | Classe=G
5kWh/1000h



Articolo: 1005285 | 8,50 EUR



1006106 839



LED
DASAR® 600 | 831



LED
DASAR® 1200 | 831



LED
DASAR® S | 833



LED
DASAR® S | 833



LED
DASAR® L | 835



LED
DASAR® L | 835



LED
DASAR® XL | 837



LED
DASAR® XL | 837



LED
DASAR®
FLAT 80 | 839



LED
DASAR®
FLAT 120 | 839



LED
DASAR® 255 | 839



LED
DASAR® 920 | 840



LED
DASAR® 920 | 840



LED
DASAR® 270 | 841



LED
DASAR® 270 | 841



SCKET
DASAR® 115 | 843



SCKET
DASAR® 115 | 843



SCKET
DASAR® 115 | 843



SCKET
DASAR®
EXACT 116 | 845



SCKET
DASAR®
EXACT 116 | 845



SCKET
DASAR® 215 | 846



SCKET
DASAR® 215 | 846



SCKET
DASAR® 215 | 847



LED
DASAR® 215 | 847



LED
TRAIL-LITE® 60 | 848



LED
POWER
TRAIL-LITE® | 849



LED
POWER
TRAIL-LITE® | 849



LED
GIMBLE OUT | 849



LED
SMALL PLOT | 851



LED
SMALL PLOT | 851



LED
SMALL PLOT | 851



LED
SMALL PLOT | 851



LED
BIG PLOT | 853



LED
BIG PLOT | 853



LED
BIG PLOT | 853



LED
BIG PLOT | 853



LED
ROCCI | 854



LED
ROCCI | 854



LED
ROCCI 200 | 855



LED
ROCCI 200 | 855



SCKET
SOLASTO | 857



SCKET
SOLASTO | 857



1007196 831



DASAR® 600 EL

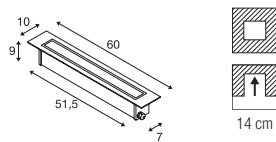

220-240V ~50/60Hz | 550mA
 Potenza del sistema: 18W
 Materiale: acciaio inox 316

- Connettore IP68 a Y incluso



Up 2200lm | 3000K

Versione	Articolo	EUR
● acciaio inox	1007195	● 549,00



Articolo	Articolo	EUR
Scatola da incasso		
● nero	1007198	29,00

DASAR® 1200 EL

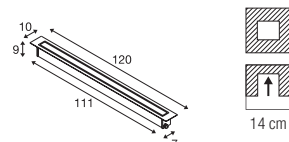

220-240V ~50/60Hz | 900mA
 Potenza del sistema: 34W
 Materiale: acciaio inox 316

- Connettore IP68 a Y incluso



Up 4100lm | 3000K

Versione	Articolo	EUR
● acciaio inox	1007196	● 729,00



Articolo	Articolo	EUR
Scatola da incasso		
● nero	1007197	49,00



1007680 833



DASAR® S RL, rotondo

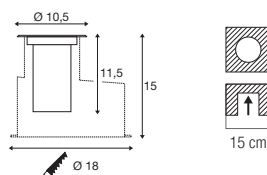

220-240V ~50/60Hz | 200mA
Potenza del sistema: 4W
Materiale: alluminio

- Connettore IP68 a Y incluso



Up 350lm | 3000K

Versione	Articolo	EUR
● antracite	1007680	● 209,00



Articolo	Articolo	EUR
Scatola da incasso per DASAR S		
● nero	1007682	49,00
○ argento	1007683	6,00
○ argento	1007684	6,00
○ argento	1007685	6,00

DASAR® S RL, quadrato

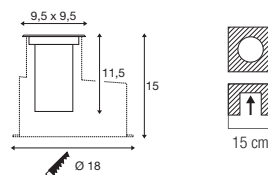

220-240V ~50/60Hz | 200mA
Potenza del sistema: 4W
Materiale: alluminio

- Connettore IP68 a Y incluso



Up 350lm | 3000K

Versione	Articolo	EUR
● antracite	1007681	● 209,00



Articolo	Articolo	EUR
Scatola da incasso per DASAR S		
● nero	1007682	49,00
○ argento	1007683	6,00
○ argento	1007684	6,00
○ argento	1007685	6,00



1007243 835



DASAR® L RL, rotondo

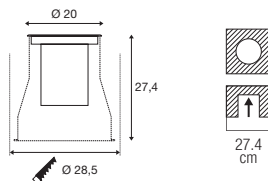

220-240V ~50/60Hz | 500mA
Potenza del sistema: 19W
Materiale: alluminio

- Connettore IP68 a Y incluso



Up 1950lm | 3000K

Versione	Articolo	EUR
● acciaio inox	1007243	● 479,00



Articolo	Articolo	EUR
Scatola da incasso per DASAR L		
● nero	1007245	49,00
Riflettore da 15° per L/XL		
● argento	1007238	12,00
Riflettore da 36° per L/XL		
● argento	1007239	12,00
Riflettore da 60° per L/XL		
● argento	1007240	12,00

DASAR® L RL, quadrato

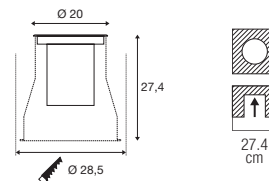

220-240V ~50/60Hz | 500mA
Potenza del sistema: 19W
Materiale: alluminio

- Connettore IP68 a Y incluso



Up 1950lm | 3000K

Versione	Articolo	EUR
● nero	1007244	● 479,00



Articolo	Articolo	EUR
Scatola da incasso per DASAR L		
● nero	1007245	49,00
Riflettore da 15° per L/XL		
● argento	1007238	12,00
Riflettore da 36° per L/XL		
● argento	1007239	12,00
Riflettore da 60° per L/XL		
● argento	1007240	12,00



1007242 837



DASAR® XL RL, rotondo

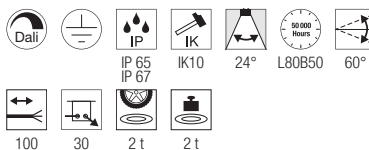
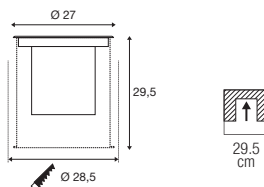

220-240V ~50/60Hz | 700mA
Potenza del sistema: 27W
Materiale: alluminio

- Connettore IP68 a Y incluso



Up 2790lm | 3000K

Versione	Articolo	EUR
● acciaio inox	1007241	● 579,00



Articolo	Articolo	EUR
Scatola da incasso per DASAR XL		
● nero	1007246	59,00
Riflettore da 15° per L/XL		
● argento	1007238	12,00
Riflettore da 36° per L/XL		
● argento	1007239	12,00
Riflettore da 60° per L/XL		
● argento	1007240	12,00

DASAR® XL RL, quadrato

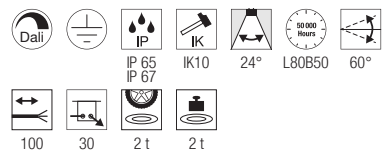
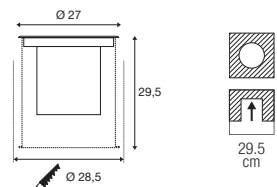

220-240V ~50/60Hz | 700mA
Potenza del sistema: 27W
Materiale: alluminio

- Connettore IP68 a Y incluso



Up 2790lm | 3000K

Versione	Articolo	EUR
● acciaio inox	1007242	● 579,00



Articolo	Articolo	EUR
Scatola da incasso per DASAR XL		
● nero	1007246	59,00
Riflettore da 15° per L/XL		
● argento	1007238	12,00
Riflettore da 36° per L/XL		
● argento	1007239	12,00
Riflettore da 60° per L/XL		
● argento	1007240	12,00



228412 839



229383 839



DASAR® FLAT 80 EL

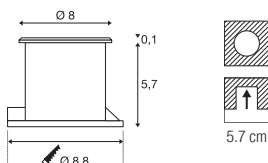

220-240V ~50/60Hz
Potenza del sistema: 3,5W
Materiale: acciaio inox 304/vetro

- L'apparecchio è adatto all'incasso nel legno
- Cavo con terminale aperto



Up 140lm | 3000K

Versione	Articolo	EUR
● acciaio inox	228412	109,00

DASAR® FLAT 120 EL

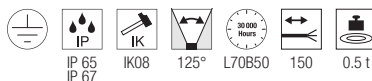
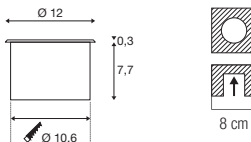

220-240V ~50/60Hz | 350mA
Potenza del sistema: 7W
Materiale: acciaio inox 304/alluminio

- Cavo con terminale aperto



Up 490lm | 3000K
540lm | 4000K

Versione	Articolo	EUR
● acciaio inox		
● acciaio inox 490lm 3000K	1006106	151,00
● acciaio inox 540lm 4000K	1006107	151,00

DASAR® 255 EL

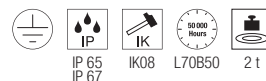
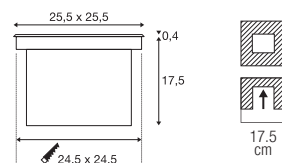

220-240V ~50/60Hz | 750mA
Potenza del sistema: 31W
Materiale: acciaio inox 316/vetro



Up 1660lm | 3000K
1720lm | 4000K

Versione	Articolo	EUR
● acciaio inox		
● acciaio inox 1660lm 3000K	229383	403,00
● acciaio inox 1720lm 4000K	229381	403,00



Articolo	Articolo	EUR
Connettore IP68, 3 poli		
● nero	228730	23,00

DASAR® 920
EL

DASAR® 920
EL

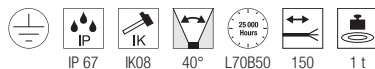
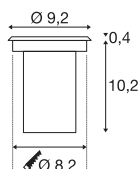
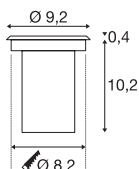

12-24V
Potenza del sistema: 6,5W
Materiale: acciaio inox 316/vetro

- Cavo con terminale aperto



Up 520lm | 3000K

Versione	Articolo	EUR
● acciaio inox	233500	151,00

220-240V ~50/60Hz | 400mA
Potenza del sistema: 5,5W
Materiale: acciaio inox 316/vetro

- Cavo con terminale aperto



Up 300lm | 3000K

Versione	Articolo	EUR
● acciaio inox	233520	197,00



Articolo	Articolo	EUR
Alimentatore LED 15W 12V		
○ bianco	1005444	29,50
Alimentatore LED 15W 24V		
○ bianco	1005445	29,50



233500 840





DASAR® 270
EL, asimmetrico

DASAR® 270
EL, simmetrico

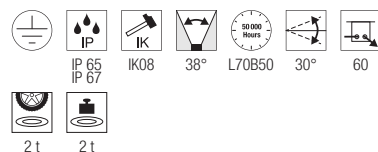
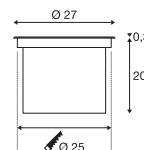
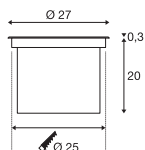

220-240V ~50/60Hz | 700mA
Potenza del sistemaPotenza assorbita: 30W
Materiale: acciaio inox 316/vetro

220-240V ~50/60Hz | 700mA
Potenza del sistemaPotenza assorbita: 30W
Materiale: acciaio inox 316/vetro



Up 2000lm | 3000K
2100lm | 4000K

Up 2500lm | 3000K
2600lm | 4000K

Versione	Articolo	EUR
● acciaio inox 2000lm 3000K	1002893	454,00
● acciaio inox 2100lm 4000K	1002895	454,00

Versione	Articolo	EUR
● acciaio inox 2500lm 3000K	1002897	454,00
● acciaio inox 2600lm 4000K	1002898	454,00



Articolo Articolo EUR

Diffusore a nido d'ape per DASAR® 270

● nero **1002899** **12,90**





229320 843



DASAR® 115
RL, quadrato, QPAR51

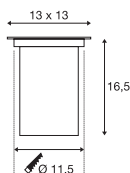

220-240V ~50/60Hz
Materiale: acciaio inox 316/vetro

SOCKET INSIDE <35 W

Attacco: 1xGU10 Ø max: 5,1 cm L: 6 cm

Versione	Articolo	EUR
● acciaio inox	229324	114,00



LED GU10 51mm | 6W | 38°
2700K | 450lm | Classe=F
6kWh/1000h



Articolo: 1005075 | 7,50 EUR

DASAR® 115
RL, rotondo, QPAR51

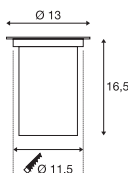

220-240V ~50/60Hz
Materiale: acciaio inox 316/vetro

SOCKET INSIDE <35 W

Attacco: 1xGU10 Ø max: 5,1 cm L: 6 cm

Versione	Articolo	EUR
● acciaio inox	229320	114,00



LED GU10 51mm | 6W | 38°
2700K | 450lm | Classe=F
6kWh/1000h



Articolo: 1005075 | 7,50 EUR

DASAR® 115
RL, quadrato, QPAR51

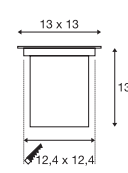

220-240V ~50/60Hz
Materiale: acciaio inox 316/vetro

SOCKET INSIDE <35 W

Attacco: 1xGU10 Ø max: 5,1 cm L: 6 cm

Versione	Articolo	EUR
● acciaio inox	229374	114,00



LED GU10 51mm | 6W | 38°
2700K | 450lm | Classe=F
6kWh/1000h



Articolo: 1005075 | 7,50 EUR





DASAR® EXACT 116
EL, quadrato, QPAR51

DASAR® EXACT 116
EL, rotondo, QPAR51

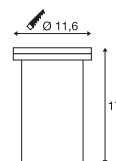
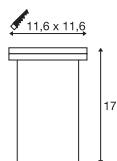

220-240V ~50/60Hz
Materiale: acciaio inox 316/vetro



220-240V ~50/60Hz
Materiale: acciaio inox 316/vetro



Attacco: 1xGU10 Ø max: 5,1 cm L: 6 cm



Attacco: 1xGU10 Ø max: 5,1 cm L: 6 cm

Versione	Articolo	EUR
● acciaio inox	228434	124,00

Versione	Articolo	EUR
● acciaio inox	228430	124,00



LED GU10 51mm | 6W | 38°
2700K | 450lm | Classe=F
6kWh/1000h



Articolo: 1005077 | 7,50 EUR



LED GU10 51mm | 6W | 38°
2700K | 450lm | Classe=F
6kWh/1000h



Articolo: 1005077 | 7,50 EUR

DASAR® 215
RL, rotondo, QPAR111

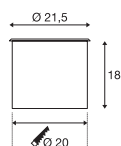

220-240V ~50/60Hz
Materiale: acciaio inox 316/vetro

SOCKET INSIDE <75
W

Attacco: 1xGU10

Versione	Articolo	EUR
● acciaio inox	229230	268,00



QPAR111 | 12,5W | 10°
3000K | 950lm | Classe=F
13kWh/1000h



Articolo: 1005278 | 55,00 EUR

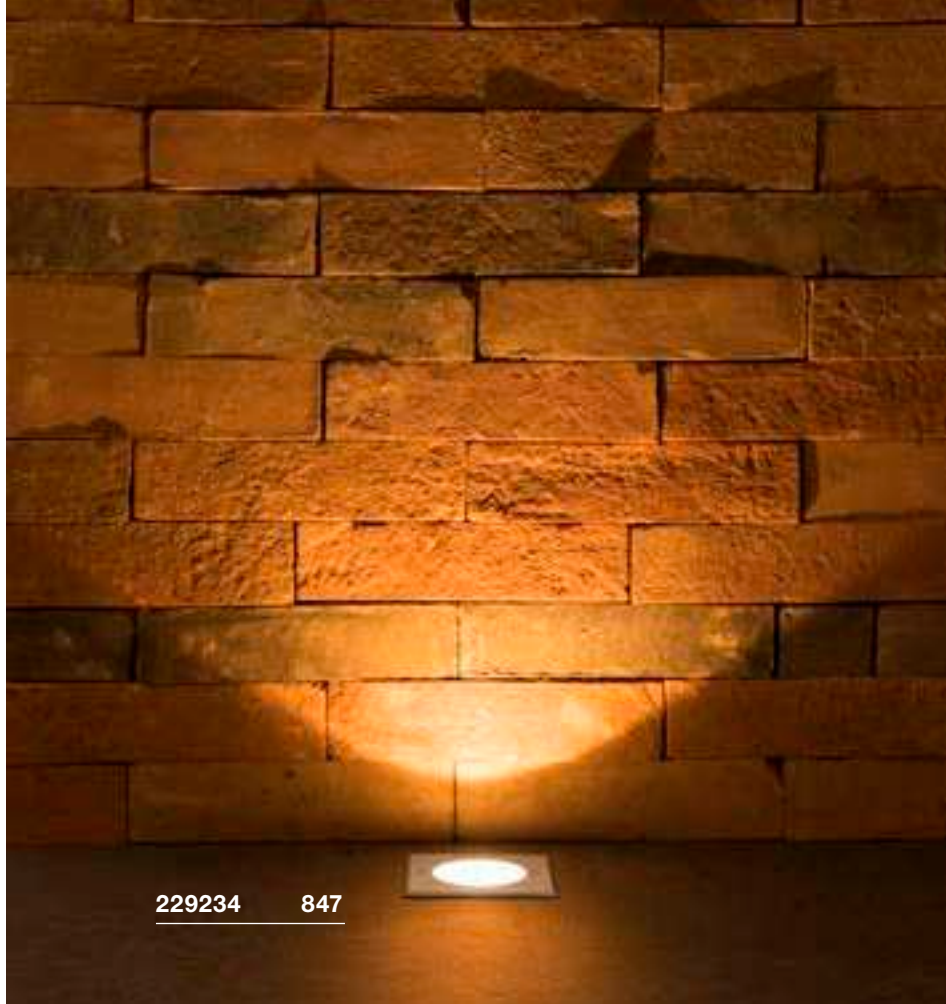



DASAR® 215
RL, quadrato, QPAR111

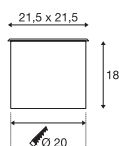

220-240V ~50/60Hz
Materiale: acciaio inox 316/vetro



Attacco: 1xGU10

Versione	Articolo	EUR
● acciaio inox	229234	268,00



QPAR111 | 12,5W | 10°
3000K | 950lm | Classe=F
13kWh/1000h



Articolo: 1005278 | 55,00 EUR

DASAR® 215
RL, rotondo, E27

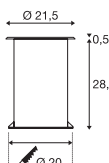

220-240V ~50/60Hz
Materiale: acciaio inox 316/vetro



Attacco: 1xE27 Ø max: 4,5 cm L: 13,4 cm

Versione	Articolo	EUR
● acciaio inox	229200	256,00



LED E27 | 8W | 240°
3000K | 880lm | Classe=E
8kWh/1000h



Articolo: 1005289 | 10,25 EUR

DASAR® 370
EL, rotondo

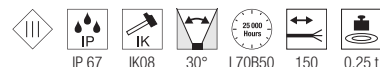
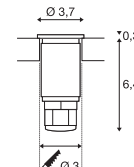

12-24V
Potenza assorbita: 2W
Materiale: acciaio inox 316/vetro

- L'apparecchio è adatto all'incasso nel legno
- Cavo con terminale aperto



Up 120lm | 3000K

Versione	Articolo	EUR
● acciaio inox	233540	171,00



Articolo	Articolo	EUR
Alimentatore LED 15W 12V		
○ bianco	1005444	29,50
Alimentatore LED 15W 24V		
○ bianco	1005445	29,50



228332 849

TRAIL-LITE® 60 EL

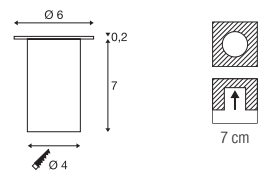

1000384 849



12V ~50/60Hz
Potenza assorbita: 0,3W
Materiale: acciaio inox 316/vetro

- Utilizzare solo con trasformatore convenzionale
- Scatola da incasso inclusa
- L'apparecchio è adatto all'incasso nel legno



Up

10lm | 3000K

Versione	Articolo	EUR
● acciaio inox	227462	70,00



POWER TRAIL-LITE® EL, quadrato

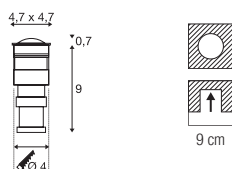

350mA
Potenza del sistema: 1W
Materiale: acciaio inox 316/vetro

- Utilizzare solo con driver da 350 mA
- In caso di collegamento di più LED allo stesso driver cablare solo in serie
- Scatola per l'incasso inclusa
- L'apparecchio è adatto all'incasso nel legno
- Cavo con terminale aperto



Up 45lm | 3000K

Versione	Articolo	EUR
● acciaio inox	228342	80,00



Articolo	Articolo	EUR
Driver LED 3W 350mA		
○ bianco	1005248	15,00

POWER TRAIL-LITE® EL, rotondo

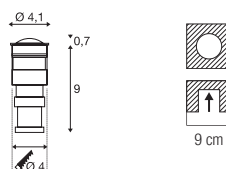

350mA
Potenza del sistema: 1W
Materiale: acciaio inox 316/vetro

- Utilizzare solo con driver da 350 mA
- In caso di collegamento di più LED allo stesso driver cablare solo in serie
- Scatola per l'incasso inclusa
- L'apparecchio è adatto all'incasso nel legno
- Cavo con terminale aperto



Up 45lm | 3000K

Versione	Articolo	EUR
● acciaio inox	228332	80,00

GIMBLE OUT EL

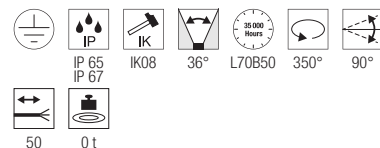
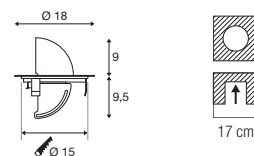

220-240V ~50/60Hz | 600mA
Potenza del sistema: 13W
Materiale: acciaio inox 316

- Cavo con terminale aperto



Up 1100lm | 3000K

Versione	Articolo	EUR
● acciaio inox	1000384	384,00



Articolo	Articolo	EUR
Scatola da incasso		
● nero	1000655	72,00
Scatola da incasso a tubo DN160		
● grigio	233792	54,00
Connettore IP68, 3 poli		
● nero	228730	23,00



1006171 + 1006173 851



SMALL PLOT Moduli



SMALL PLOT Moduli



SMALL PLOT Cover, 2 fasci



H: 1,7 cm
 Ø: 10,3 cm
 Materiale 1006174: alluminio
 Materiale 1006173: acciaio inox 316

- 500 kg di carico per 1006174
- 800 kg di carico per 1006173

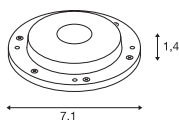
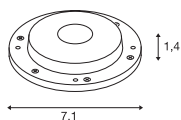

24V DC
 Potenza assorbita: 2,6W
 Materiale: alluminio/
 polimetilmetacrilato (PMMA)

- Il prodotto viene fornito senza cover
- Cavo con terminale aperto



Up 240lm | 3000K

Versione	Articolo	EUR
● alluminio	1006172	82,00



24V DC
 Potenza assorbita: 2,6W
 Materiale: acciaio inox/
 polimetilmetacrilato (PMMA)

- Il prodotto viene fornito senza cover
- Cavo con terminale aperto



Up 240lm | 3000K

Versione	Articolo	EUR
● acciaio inox	1006171	97,00

Versione	Articolo	EUR
● antracite	1006174	42,25
● acciaio inox	1006173	141,00

SMALL PLOT Cover, 4 fasci



800 kg

H: 1,7 cm
 Ø: 10,3 cm
 Materiale 1006176: alluminio
 Materiale 1006175: acciaio inox 316

- 500 kg di carico per 1006176
- 800 kg di carico per 1006175



Articolo	Articolo	EUR
Alimentatore LED 18/20W 12/24V		
○ bianco	1005381	39,50
Alimentatore LED 15W 24V rotondo		
○ bianco	1005445	29,50



Articolo	Articolo	EUR
Alimentatore LED 18/20W 12/24V		
○ bianco	1005381	39,50
Alimentatore LED 15W 24V rotondo		
○ bianco	1005445	29,50

Versione	Articolo	EUR
● antracite	1006176	42,25
● acciaio inox	1006175	141,00



1001359 + 1001255 853



BIG PLOT Moduli

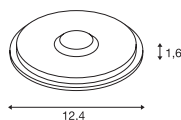
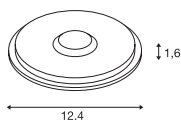

220-240V ~50/60Hz
Potenza del sistema: 5,5W
Materiale: alluminio/
polimetilmetacrilato (PMMA)

- Prodotto fornito senza cover
- Cavo con terminale aperto



Up 500lm | 3000K

Versione	Articolo	EUR
● alluminio	1001256	92,00



Articolo	Articolo	EUR
Connettore IP68 a T, 3 poli		
● nero	228726	36,00
Connettore IP68, 3 poli		
● nero	228730	23,00

BIG PLOT Moduli

220-240V ~50/60Hz
Potenza del sistema: 5,5W
Materiale: acciaio inox/
polimetilmetacrilato (PMMA)

- Prodotto fornito senza cover
- Cavo con terminale aperto



Up 500lm | 3000K

Versione	Articolo	EUR
● acciaio inox	1001359	133,00



Articolo	Articolo	EUR
Connettore IP68 a T, 3 p		
● nero	228726	36,00
Connettore IP68, 3 poli		
● nero	228730	23,00

BIG PLOT Cover, 2 fasci



H: 2 cm
Ø: 17 cm
Materiale 1001262: alluminio
Materiale 1001254: acciaio inox 316

- 500 kg di carico per 1001262
- 800 kg di carico per 1001254

Versione	Articolo	EUR
● antracite	1001262	56,00
● acciaio inox	1001254	198,00

BIG PLOT Cover, 4 fasci



800 kg

H: 2 cm
Ø: 17 cm
Materiale 1001263: alluminio
Materiale 1001255: acciaio inox 316

- 500 kg di carico per 1001263
- 800 kg di carico per 1001255

Versione	Articolo	EUR
● antracite	1001263	56,00
● acciaio inox	1001255	198,00

ROCCI
EL, quadrato

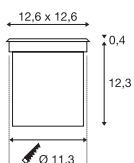

100-277V ~50/60Hz | 700mA
Potenza del sistema: 8,6W
Materiale: acciaio inox 316/vetro



Up 580lm | 3000K

Versione	Articolo	EUR
● acciaio inox	227604	167,00

ROCCI
EL, rotondo

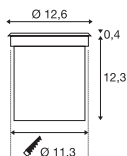

100-277V ~50/60Hz | 700mA
Potenza del sistema: 8,6W
Materiale: acciaio inox 316/vetro



Up 580lm | 3000K

Versione	Articolo	EUR
● acciaio inox	227600	167,00





227604 854

ROCCI 200
EL, quadrato

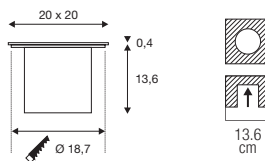

ROCCI 200
EL, rotondo

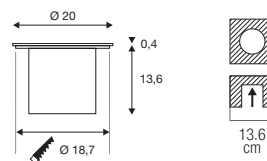

1006105 855

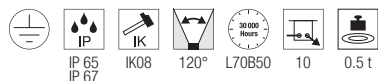

100-277V ~50/60Hz | 350mA
Potenza del sistema: 16W
Materiale: acciaio inox 316/vetro



Up 1530lm | 3000K

Versione	Articolo	EUR
● acciaio inox	1006105	187,00

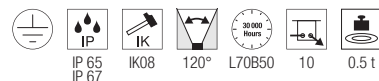

100-277V ~50/60Hz | 350mA
Potenza del sistema: 16W
Materiale: acciaio inox 316/vetro



Up 1530lm | 3000K

Versione	Articolo	EUR
● acciaio inox	1006104	187,00



227680

857



SOLASTO EL, quadrato

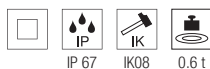
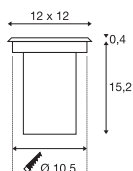

220-240V ~50/60Hz
Materiale: acciaio inox 304/vetro



Attacco: 1xGU10

Versione	Articolo	EUR
● acciaio inox	227684	70,00



LED GU10 51mm | 6W | 38°
2700K | 450lm | Classe=F
6kWh/1000h



Articolo: 1005075 | 7,50 EUR

SOLASTO EL, rotondo

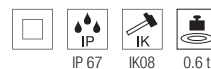
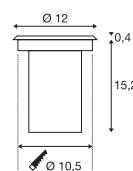

220-240V ~50/60Hz
Materiale: acciaio inox 304/vetro



Attacco: 1xGU10

Versione	Articolo	EUR
● acciaio inox	227680	70,00



LED GU10 51mm | 6W | 38°
2700K | 450lm | Classe=F
6kWh/1000h



Articolo: 1005075 | 7,50 EUR

1006400 281





LED QT | 860



LED C35 | 860



LED TCR-TSE | 860



LED QR51 | 861



LED QPAR51 | 861



LED | 862

LED QPAR111 |
862, 863, 864

QPAR111 | 862, 863



LED A60 | 864, 865



LED T32 | 861



LED T38 | 865



LED T45 | 865



LED ST64 | 865



LED ST58 | 865



LED G125 | 865

LED QT14 G9



220-240V ~50/60Hz
Potenza: 3,6W
Materiale: ceramica
Ø: 1,8 cm L: 5,4 cm

Flusso luminoso	400lm
Corrente della lampada	0,03A
Indice di resa cromatica	93
Potenza	3,6W
Consumo energetico/1000h	4kWh

Versione	Articolo	EUR
○ bianco 3000K	1005286	9,99

LED QT-DE12 R7S, 78 mm



220-240V ~50/60Hz
Potenza: 9W
Materiale: policarbonato (PC)
Ø: 2,9 cm L: 2,9 cm

Flusso luminoso	1050lm
Corrente della lampada	0,043A
Indice di resa cromatica	95
Potenza	9W
Consumo energetico/1000h	9kWh

Versione	Articolo	EUR
● grigio 3000K	1005287	24,00

LED QT-DE12 R7S, 118 mm



220-240V ~50/60Hz
Potenza: 15W
Materiale: policarbonato (PC)
Ø: 2,9 cm L: 2,9 cm

Flusso luminoso	2000lm
Corrente della lampada	0,068A
Indice di resa cromatica	92
Potenza	15W
Consumo energetico/1000h	15kWh

Versione	Articolo	EUR
● grigio 3000K	1005288	28,50

LED C35 E14



220-240V ~50/60Hz
Potenza: 4,2W
Materiale: vetro
Ø: 3,5 cm L: 9,8 cm

Flusso luminoso	380lm
Corrente della lampada	0,025A
Indice di resa cromatica	90
Potenza	4,2W
Consumo energetico/1000h	5kWh

Versione	Articolo	EUR
○ trasparente 2700K	1005284	6,50

LED C35 E14



220-240V ~50/60Hz
Potenza: 4,2W
Materiale: vetro
Ø: 3,5 cm L: 9,8 cm

Flusso luminoso	350lm
Corrente della lampada	0,025A
Indice di resa cromatica	90
Potenza	4,2W
Consumo energetico/1000h	5kWh

Versione	Articolo	EUR
○ bianco 2700K	1005285	8,50

LED TCR-TSE GX53



220-240V ~50/60Hz
Potenza: 6,1W
Materiale: policarbonato (PC) /
policarbonato (PC)
Ø: 7,5 cm L: 2,4 cm

Flusso luminoso	490lm
Corrente della lampada	0,034A
Indice di resa cromatica	93
Potenza	6,1W
Consumo energetico/1000h	6kWh

Versione	Articolo	EUR
○ bianco 2700K	1005272	11,50
○ bianco 3000K	1005271	11,50
○ bianco 4000K	1005269	11,50

**LED QR51**
GU5.3

12V AC
Potenza: 5,8W
Materiale: vetro
Ø: 5 cm L: 4,5 cm

Flusso luminoso	450lm
Corrente della lampada	0,63A
Intensità luminosa max.	1300cd
Indice di resa cromatica	90
Potenza	5,8W
Consumo energetico/1000h	6kWh

Versione	Articolo	EUR
<input type="radio"/> trasparente		
2700K	1001574	35,00
<input type="radio"/> trasparente		
3000K	1001575	35,00

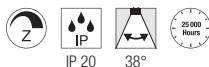
LED QPAR51
GU10, tunable 2700-6500K, smart

220-240V ~50/60Hz
Potenza: 5W
Materiale: poliammide 66 (PA 66) /
policarbonato (PC)
Ø: 5 cm L: 5,4 cm

Flusso luminoso	350lm
Corrente della lampada	0,04A
Intensità luminosa max.	530cd
Indice di resa cromatica	92
Potenza	5W
Consumo energetico/1000h	5kWh

Versione	Articolo	EUR
<input type="radio"/> bianco		
2700-6500K	1005311	37,75

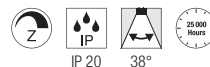
LED QPAR51
GU10, RGBW, smart

220-240V ~50/60Hz
Potenza: 5,2W
Materiale: poliammide 66 (PA 66) /
policarbonato (PC)
Ø: 5 cm L: 6,1 cm

Flusso luminoso	350lm
Corrente della lampada	0,042A
Intensità luminosa max.	680cd
Indice di resa cromatica	92
Potenza	5,2W
Consumo energetico/1000h	5kWh

Versione	Articolo	EUR
<input type="radio"/> bianco	1005312	54,00

LED QPAR51
GU10

220-240V ~50/60Hz
Potenza: 2,4W
Materiale: vetro
Ø: 5 cm L: 5,4 cm

Flusso luminoso	230lm
Corrente della lampada	0.025A
Intensità luminosa max.	450cd
Indice di resa cromatica	80
Potenza	2,4W
Consumo energetico/1000h	3kWh

Versione	Articolo	EUR
<input type="radio"/> trasparente		
2700K	1007230	6,50
<input type="radio"/> trasparente		
3000K	1007231	6,50

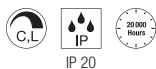
LED T32
GU10

220-240V ~50/60Hz
Potenza: 3,2W
Materiale: vetro
Ø: 3,2 cm L: 10 cm

Flusso luminoso	270lm
Corrente della lampada	0.0175A
Indice di resa cromatica	90
Potenza	3,2W

Versione	Articolo	EUR
<input type="radio"/> trasparente		
2700K	1006321	48,00

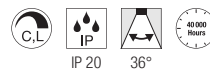
LED QPAR51
GU10

220-240V ~50/60Hz
Potenza: 6W
Materiale: vetro
Ø: 5 cm L: 5 cm

Flusso luminoso	360lm
Corrente della lampada	0.033A
Intensità luminosa max.	680cd
Indice di resa cromatica	93
Potenza	6W
Consumo energetico/1000h	6kWh

Versione	Articolo	EUR
<input type="radio"/> argento		
2200-2700K	1005273	9,99

LED QPAR51 GU10

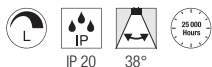

220-240V ~50/60Hz
Potenza: 6W
Materiale: policarbonato (PC)
Ø: 5 cm L: 5 cm

Flusso luminoso	450lm
Corrente della lampada	0.037A
Intensità luminosa max.	880cd
Indice di resa cromatica	92
Potenza	6W
Consumo energetico/1000h	6kWh

Versione	Articolo	EUR
● nero 2700K	1005077	7,50
● nero 3000K	1005080	7,50
● nero 4000K	1005083	7,50

LED QPAR51 GU10

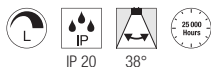

220-240V ~50/60Hz
Potenza: 6W
Materiale: policarbonato (PC)
Ø: 5 cm L: 5 cm

Flusso luminoso	450lm
Corrente della lampada	0.037A
Intensità luminosa max.	880cd
Indice di resa cromatica	92
Potenza	6W
Consumo energetico/1000h	6kWh

Versione	Articolo	EUR
○ bianco 2700K	1005076	7,50
○ bianco 3000K	1005079	7,50
○ bianco 4000K	1005082	7,50

LED QPAR51 GU10

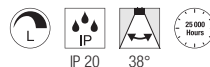

220-240V ~50/60Hz
Potenza: 6W
Materiale: policarbonato (PC)
Ø: 5 cm L: 5,4 cm

Flusso luminoso	450lm
Corrente della lampada	0.037A
Intensità luminosa max.	880cd
Indice di resa cromatica	92
Potenza	6W
Consumo energetico/1000h	6kWh

Versione	Articolo	EUR
● grigio 2700K	1005075	7,50
● grigio 3000K	1005078	7,50
● grigio 4000K	1005081	7,50

LED QPAR111 GU10

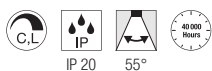

220-240V ~50/60Hz
Potenza: 12W
Materiale: alluminio
Ø: 11 cm L: 7 cm

Flusso luminoso	680lm
Corrente della lampada	0.05A
Intensità luminosa max.	930cd
Indice di resa cromatica	90
Potenza	12W
Consumo energetico/1000h	12kWh

Versione	Articolo	EUR
● alluminio 2700K	1005297	85,00
● alluminio 3000K	1005298	85,00
● alluminio 4000K	1005299	85,00

QPAR111 GU10, RGBW, smart

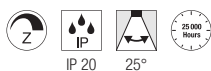

220-240V ~50/60Hz
Potenza: 10W
Materiale: alluminio
Ø: 11,1 cm L: 7 cm

Flusso luminoso	750lm
Corrente della lampada	0.059A
Intensità luminosa max.	3500cd
Indice di resa cromatica	94
Potenza	10W
Consumo energetico/1000h	10kWh

Versione	Articolo	EUR
○ bianco	1005315	68,00

QPAR111 GU10, RGBW, smart

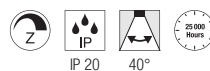

220-240V ~50/60Hz
Potenza: 10W
Materiale: alluminio/policarbonato (PC)
Ø: 11,1 cm L: 7 cm

Flusso luminoso	780lm
Corrente della lampada	0.059A
Intensità luminosa max.	2000cd
Indice di resa cromatica	94
Potenza	10W
Consumo energetico/1000h	10kWh

Versione	Articolo	EUR
○ bianco	1005316	68,00

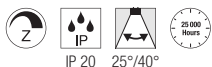
**QPAR111**
GU10, tunable 2700-6500K, smart

220-240V ~50/60Hz
Potenza: 10W
Materiale: alluminio/policarbonato (PC)
Ø: 11,1 cm L: 7 cm

Flusso luminoso	760lm
Corrente della lampada	0,053A
Intensità luminosa max.	4000cd
Indice di resa cromatica	93
Potenza	10W
Consumo energetico/1000h	10kWh

Versione	Articolo	EUR
○ bianco		
2700-6500K 25°	1005313	52,00
○ bianco		
2700-6500K 40°	1005314	52,00

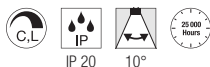
LED QPAR111
GU10

220-240V ~50/60Hz
Potenza: 12,5W
Materiale: alluminio
Ø: 11,1 cm L: 7 cm

Flusso luminoso	900lm
Corrente della lampada	0,058A
Intensità luminosa max.	11000cd
Indice di resa cromatica	90
Potenza	12,5W
Consumo energetico/1000h	13kWh

Versione	Articolo	EUR
● argento		
2700K	1005275	55,00
● argento		
3000K	1005278	55,00
● argento		
4000K	1005281	55,00

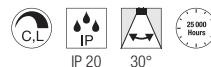
LED QPAR111
GU10

220-240V ~50/60Hz
Potenza: 12,5W
Materiale: alluminio
Ø: 11,1 cm L: 7 cm

Flusso luminoso	950lm
Corrente della lampada	0,058A
Intensità luminosa max.	3000cd
Indice di resa cromatica	93
Potenza	12,5W
Consumo energetico/1000h	13kWh

Versione	Articolo	EUR
● argento		
2700K	1005276	49,50
● argento		
3000K	1005279	49,50
● argento		
4000K	1005282	49,50

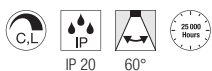
LED QPAR111
GU10

220-240V ~50/60Hz
Potenza: 12,5W
Materiale: alluminio
Ø: 11,1 cm L: 7 cm

Flusso luminoso	1000lm
Corrente della lampada	0,058A
Intensità luminosa max.	1000cd
Indice di resa cromatica	93
Potenza	12,5W
Consumo energetico/1000h	13kWh

Versione	Articolo	EUR
● argento		
2700K	1005277	49,50
● argento		
3000K	1005280	49,50
● argento		
4000K	1005283	49,50

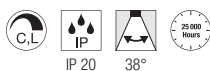
LED QPAR111
GU10

220-240V ~50/60Hz
Potenza: 8W
Materiale: vetro
Ø: 11,1 cm L: 6,1 cm

Flusso luminoso	680lm
Corrente della lampada	0,046A
Intensità luminosa max.	1300cd
Indice di resa cromatica	93
Potenza	8W
Consumo energetico/1000h	8kWh

Versione	Articolo	EUR
● trasparente		
2700K	1005274	30,75

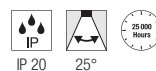
LED QPAR111
GU10

220-240V ~50/60Hz
Potenza: 7,3W
Materiale: plastica/alluminio
Ø: 11,1 cm L: 7,1 cm

Flusso luminoso	530lm
Corrente della lampada	0,051A
Intensità luminosa max.	1400cd
Indice di resa cromatica	93
Potenza	7,3W
Consumo energetico/1000h	8kWh

Versione	Articolo	EUR
● argento		
2700K	1005291	24,50
● argento		
3000K	1005292	24,50

LED QPAR111 GU10

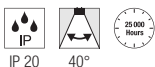

220-240V ~50/60Hz
Potenza: 7,3W
Materiale: plastica/alluminio
Ø: 11,1 cm L: 7,1 cm

Flusso luminoso	500lm
Corrente della lampada	0.051A
Intensità luminosa max.	1000cd
Indice di resa cromatica	93
Potenza	7,3W
Consumo energetico/1000h	8kWh

Versione	Articolo	EUR
<input type="radio"/> argento 2700K	1005294	24,50
<input type="radio"/> argento 3000K	1005295	24,50
<input type="radio"/> argento 4000K	1005296	24,50

LED A60 E27, tunable 2700-6500K, smart

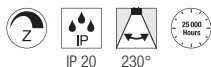

220-240V ~50/60Hz
Potenza: 9W
Materiale: poliammide 66 (PA 66)
Ø: 6 cm L: 11 cm

Flusso luminoso	800lm
Corrente della lampada	0.067A
Indice di resa cromatica	92
Potenza	9W
Consumo energetico/1000h	9kWh

Versione	Articolo	EUR
<input type="radio"/> bianco 2700-6500K	1005317	32,00

LED A60 E27, RGBW, smart

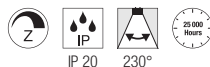

220-240V ~50/60Hz
Potenza: 9W
Materiale: poliammide 66 (PA 66) /
policarbonato (PC)
Ø: 6 cm L: 11 cm

Flusso luminoso	800lm
Corrente della lampada	0.073A
Indice di resa cromatica	92
Potenza	9W
Consumo energetico/1000h	9kWh

Versione	Articolo	EUR
<input type="radio"/> bianco	1005318	44,50

LED A60 E27

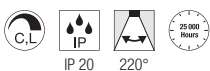

220-240V ~50/60Hz
Potenza: 9W
Materiale: plastica
Ø: 6 cm L: 11 cm

Flusso luminoso	800lm
Corrente della lampada	0.048A
Indice di resa cromatica	90
Potenza	9W
Consumo energetico/1000h	9kWh

Versione	Articolo	EUR
<input type="radio"/> bianco 2700K	1005301	7,35

LED A60 E27

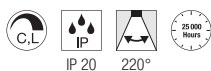

220-240V ~50/60Hz
Potenza: 13,2W
Materiale: plastica
Ø: 6 cm L: 12 cm

Flusso luminoso	1300lm
Corrente della lampada	0.062A
Indice di resa cromatica	93
Potenza	13,2W
Consumo energetico/1000h	13kWh

Versione	Articolo	EUR
<input type="radio"/> bianco 2700K	1005302	12,25

LED A60 E27



220-240V ~50/60Hz
Potenza: 7,5W
Materiale: vetro
Ø: 6 cm L: 10,5 cm

Flusso luminoso	800lm
Corrente della lampada	0.038A
Indice di resa cromatica	93
Potenza	7,5W
Consumo energetico/1000h	8kWh

Versione	Articolo	EUR
<input type="radio"/> trasparente 2700K	1005303	9,60

**LED T38**
E27

220-240V ~50/60Hz
Potenza: 8W
Materiale: plastica
Ø: 3,8 cm L: 11,6 cm

Flusso luminoso	880lm
Corrente della lampada	0.035A
Indice di resa cromatica	94
Potenza	8W
Consumo energetico/1000h	8kWh

Versione	Articolo	EUR
<input type="radio"/> bianco		
<input type="radio"/> 3000K	1005289	10,25
<input type="radio"/> bianco		
<input type="radio"/> 4000K	1005290	10,25

LED T45
E27

220-240V ~50/60Hz
Potenza: 13,5W
Materiale: plastica
Ø: 4,5 cm L: 14 cm

Flusso luminoso	1520lm
Corrente della lampada	0.06A
Indice di resa cromatica	94
Potenza	13,5W
Consumo energetico/1000h	14kWh

Versione	Articolo	EUR
<input type="radio"/> bianco		
<input type="radio"/> 3000K	1005307	12,50
<input type="radio"/> bianco		
<input type="radio"/> 4000K	1005308	12,50

LED ST64
E27

220-240V ~50/60Hz
Potenza: 7,5W
Materiale: vetro
Ø: 6,4 cm L: 14,5 cm

Flusso luminoso	700lm
Corrente della lampada	0.038A
Indice di resa cromatica	90
Potenza	7,5W
Consumo energetico/1000h	8kWh

Versione	Articolo	EUR
<input checked="" type="radio"/> oro		
<input type="radio"/> 2500K	1005265	26,50

LED A60
E27, Mirrorhead, Chrom

220-240V ~50/60Hz
Potenza: 7,5W
Materiale: vetro
Ø: 6 cm L: 10,5 cm

Flusso luminoso	720lm
Corrente della lampada	0.038A
Indice di resa cromatica	92
Potenza	7,5W
Consumo energetico/1000h	8kWh

Versione	Articolo	EUR
<input checked="" type="radio"/> cromo		
<input type="radio"/> 2700K	1005305	19,00

LED ST58
E27

220-240V ~50/60Hz
Potenza: 7,5W
Materiale: vetro
Ø: 5,8 cm L: 14,2 cm

Flusso luminoso	800lm
Corrente della lampada	0.038A
Indice di resa cromatica	93
Potenza	7,5W
Consumo energetico/1000h	8kWh

Versione	Articolo	EUR
<input type="radio"/> trasparente		
<input type="radio"/> 2700K	1005268	12,25

LED G125
E27

220-240V ~50/60Hz
Potenza: 7,5W
Materiale: vetro
Ø: 12,5 cm L: 17,8 cm

Flusso luminoso	800lm
Corrente della lampada	0.038A
Indice di resa cromatica	93
Potenza	7,5W
Consumo energetico/1000h	8kWh

Versione	Articolo	EUR
<input type="radio"/> trasparente		
<input type="radio"/> 2700K	1005310	18,50



1007300 151

1007308 151

1002913 189



TRASFORMATORE
TENSEO | 868



TRASFORMATORE
| 868



DALI INTERFACE | 868



CONVERTITORE | 868



DIMMER UNIVERSALE
DALI | 869



CONTROLLER
DALI | 869



CONTROLLER | 869



ALIMENTATORE
LED | 869, 870, 871



ALIMENTATORE LED
DIMMERABILE | 871,
872



DRIVER LED | 870,
872, 875, 876, 877



DRIVER LED
DIMMERABILE | 871,
872, 873, 874, 875



MODULO
RF | 874, 875



GANCI PER
SOFFITTO | 878



SERRACAVO | 878



GLENOS® ROSONE
A PLAFONE | 878



CAVO IN
TESSUTO | 878



CAVO
TRIPOLARE | 878



CAVO DI
SOSPENSIONE IN
ACCIAIO | 878

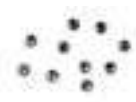

STOPPER PER CAVO
IN ACCIAIO | 879



PROLUNGA CAVI | 879



PRESA
MULTIPLA | 879



NASTRO
BI-ADESIVO | 879



GU10 LED
CONNECTION
BOX | 880



GU10
CONNECTION
BOX | 880



ATTACCO GU10 | 880



SCATOLA DI
COLLEGAMENTO
| 881



SCATOLA DI
COLLEGAMENTO
A T | 881



CONNECTION
BOX | 881

TRASFORMATORE TENSEO
12V AC | 50VA convenzionale



220-240V ~50/60Hz
H: 11 cm
Ø: 11,1 cm
Materiale: acciaio/ottone

Tensione in uscita	12V AC
Potenza fino a	60W
Protezione termica	130°C
Numero di uscite secondarie	1

Versione	Articolo	EUR
● nero	1002691	111,00
○ bianco	1002692	111,00
● cromo	1002693	115,00

TRASFORMATORE TENSEO
12V AC | 105VA convenzionale



220-240V ~50/60Hz
H: 11 cm
Ø: 11,1 cm
Materiale: acciaio/vetro

Tensione in uscita	12V AC
Potenza fino a	105W
Protezione termica	130°C
Numero di uscite secondarie	1

Versione	Articolo	EUR
○ bianco	138981	135,00
● cromo	138982	147,00

TRASFORMATORE TENSEO
12V AC | 210VA convenzionale



220-240V ~50/60Hz
H: 11 cm
Ø: 13,5 cm
Materiale: acciaio/ottone

Tensione in uscita	12V AC
Potenza fino a	210W
Protezione termica	130°C
Numero di uscite secondarie	1

Versione	Articolo	EUR
○ bianco	138991	204,00
● cromo	138992	213,00

MINI TRASFORMATORE
60VA | 12V AC



230V ~50Hz
L: 10,5 cm La: 3,3 cm H: 2,2 cm
Materiale: policarbonato (PC)

Tensione in uscita	12V AC
Potenza da	10W
Potenza fino a	60W
Fattore di potenza dell'apparecchio	0.98
Protezione termica	110°C
Numero di uscite secondarie	1

Versione	Articolo	EUR
○ bianco	461060	28,00

INTERFACCIA DALI/1-10V
1-10V + on/off



250V AC
L: 5,85 cm La: 3,25 cm H: 1,5 cm
Materiale: plastica

- Per la regolazione di ballast elettronici con ingresso comando 1-10V
- Separazione galvanica tra ingresso DALI e uscita 1-10V

Tensione in uscita	250V AC
Potenza fino a	1000W

Versione	Articolo	EUR
● grigio	1002218	269,00

INTERFACCIA DALI/PHASE
Phase dim -> DALI



100-240V ~50/60Hz
L: 4,6 cm La: 4,5 cm H: 2 cm
Materiale: policarbonato (PC)

Tensione in uscita	100-240V AC
Potenza da	0W
Potenza fino a	200W

Versione	Articolo	EUR
○ bianco	1006452	79,00



DIMMER UNIVERSALE DALI 10-300W



230V AC
L: 12,02 cm La: 3,02 cm H: 2,16 cm
Materiale: plastica

- Adatto per carico R, L, C grazie al riconoscimento automatico.
- Corrente assorbita DALI: 6mA

Tensione in uscita	230V AC
Potenza da	10W
Potenza fino a	300W

Versione	Articolo	EUR
● grigio	1002221	359,00

CONTROLLER DALI/PUSH 24V DC

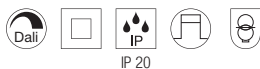

10V-24V DC
L: 11,6 cm La: 4,2 cm H: 1,8 cm
Materiale: policarbonato (PC)

- Potenza max: 50W-120W
- Corrente max: 5A
- Funzionalità DALI e DALI-PUSH

Tensione	10-24V DC
Numero di uscite secondarie	1

Versione	Articolo	EUR
○● bianco/grigio	1003106	64,00

CONTROLLER ZIGBEE LED Stip CCT / RGBW



NEW



12V/24V DC
L: 14,5 cm La: 4,65 cm H: 1,6 cm
Materiale: policarbonato (PC)

- Potenza max: 5 x 48W (12V) - 96W (24V)
- Corrente max: 5 x 5A

Tensione in uscita	12-24V DC
Potenza da	48W
Potenza fino a	96W
Protezione termica	100°C

Versione	Articolo	EUR
○ bianco	1006348	80,00

ALIMENTATORE LED 15W | 12V

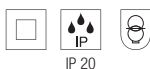

200-240V ~50/60Hz
H: 2,5 cm
Ø: 5,5 cm
Materiale: policarbonato (PC)

Tensione in uscita	12V DC
Potenza da	0W
Potenza fino a	15W
Fattore di potenza dell'apparecchio	0,9
Protezione termica	110°C
Numero di uscite secondarie	1

Versione	Articolo	EUR
○ bianco	1005444	29,50

ALIMENTATORE LED 15W | 24V

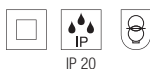

200-240V ~50/60Hz
H: 2,2 cm
Ø: 5,5 cm
Materiale: policarbonato (PC)

Tensione in uscita	24V DC
Potenza da	0W
Potenza fino a	15W
Fattore di potenza dell'apparecchio	0,9
Protezione termica	110°C
Numero di uscite secondarie	1

Versione	Articolo	EUR
○ bianco	1005445	29,50

ALIMENTATORE LED 20W | 12/24V



220-240V ~50/60Hz
L: 11,5 cm La: 4,1 cm H: 2,5 cm
Materiale: policarbonato (PC)

Tensione in uscita	12/24V DC
Potenza da	0W
Potenza fino a	18W/20W
Fattore di potenza dell'apparecchio	0,95
Protezione termica	110°C
Numero di uscite secondarie	1

Versione	Articolo	EUR
○ bianco	1005381	39,50

DRIVER LED
30W | 24V



220-240V ~50/60Hz
L: 30 cm La: 3 cm H: 1,6 cm
Materiale: policarbonato (PC)

Tensione in uscita	24V DC
Potenza da	0W
Potenza fino a	30W
Fattore di potenza dell'apparecchio	0.95
Protezione termica	110°C
Numero di uscite secondarie	1

Versione	Articolo	EUR
<input type="radio"/> bianco	1007250	50,00

DRIVER LED
100W | 24V DC



220-240V ~50/60Hz
L: 35 cm La: 3 cm H: 1,8 cm
Materiale: policarbonato (PC)

Tensione in uscita	24V DC
Potenza da	0W
Potenza fino a	100W
Fattore di potenza dell'apparecchio	0.95
Protezione termica	110°C
Numero di uscite secondarie	1

Versione	Articolo	EUR
<input type="radio"/> bianco	1007251	80,00

DRIVER LED
150W | 24V DC



220-240V ~50/60Hz
L: 35 cm La: 3 cm H: 1,8 cm
Materiale: policarbonato (PC)

Tensione in uscita	24V DC
Potenza da	0W
Potenza fino a	150W
Fattore di potenza dell'apparecchio	0.95
Protezione termica	110°C
Numero di uscite secondarie	1

Versione	Articolo	EUR
<input type="radio"/> bianco	1007252	100,00

DRIVER LED
250W | 24V DC



220-240V ~50/60Hz
L: 40 cm La: 4 cm H: 2,2 cm
Materiale: policarbonato (PC)

Tensione in uscita	24V DC
Potenza da	0W
Potenza fino a	250W
Fattore di potenza dell'apparecchio	0.95
Protezione termica	110°C
Numero di uscite secondarie	1

Versione	Articolo	EUR
<input type="radio"/> bianco	1007253	120,00

DRIVER LED
25W | 24V

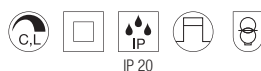

220-240V ~50/60Hz
L: 12,8 cm La: 5,2 cm H: 3 cm
Materiale: policarbonato (PC) / policarbonato (PC)

Tensione in uscita	24V DC
Potenza da	9.6W
Potenza fino a	25W
Fattore di potenza dell'apparecchio	0.95
Protezione termica	110°C
Numero di uscite secondarie	1

Versione	Articolo	EUR
<input type="radio"/> bianco/grigio	1006336	35,00

DRIVER LED
50W | 24V

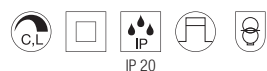

220-240V ~50/60Hz
L: 18,4 cm La: 6,1 cm H: 3,2 cm
Materiale: policarbonato (PC) / policarbonato (PC)

Tensione in uscita	24V DC
Potenza da	12W
Potenza fino a	50W
Fattore di potenza dell'apparecchio	0.95
Protezione termica	110°C
Numero di uscite secondarie	1

Versione	Articolo	EUR
<input type="radio"/> bianco/blu	1003104	49,50



DRIVER LED 100W | 24V DC

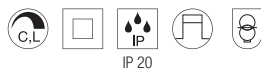

220-240V ~50/60Hz
L: 21 cm La: 6,7 cm H: 3,4 cm
Materiale: policarbonato (PC) /
policarbonato (PC)

Tensione in uscita	24V DC
Potenza da	33W
Potenza fino a	100W
Fattore di potenza dell'apparecchio	0.95
Protezione termica	110°C
Numero di uscite secondarie	1

Versione	Articolo	EUR
<input checked="" type="radio"/> bianco/blu	1003105	121,00

DRIVER LED DALI 30W | 24V DC DALI

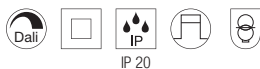

220-240V ~50/60Hz
L: 30 cm La: 3 cm H: 1,6 cm
Materiale: policarbonato (PC)

Tensione in uscita	24V DC
Potenza da	12W
Potenza fino a	30W
Fattore di potenza dell'apparecchio	0.95
Protezione termica	110°C
Numero di uscite secondarie	1

Versione	Articolo	EUR
<input type="radio"/> bianco	1007254	60,00

DRIVER LED DALI 100W | 24V DC DALI

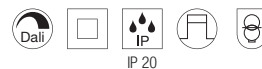

220-240V ~50/60Hz
L: 35 cm La: 3 cm H: 1,8 cm
Materiale: policarbonato (PC)

Tensione in uscita	24V DC
Potenza da	30W
Potenza fino a	100W
Fattore di potenza dell'apparecchio	0.95
Protezione termica	110°C
Numero di uscite secondarie	1

Versione	Articolo	EUR
<input type="radio"/> bianco	1007255	110,00

DRIVER LED DALI 150W | 24V DC DALI

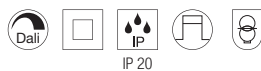

220-240V ~50/60Hz
L: 35 cm La: 3 cm H: 1,8 cm
Materiale: policarbonato (PC)

Tensione in uscita	24V DC
Potenza da	45W
Potenza fino a	150W
Fattore di potenza dell'apparecchio	0.95
Protezione termica	110°C
Numero di uscite secondarie	1

Versione	Articolo	EUR
<input type="radio"/> bianco	1007256	140,00

DRIVER LED DALI 250W | 24V DC DALI

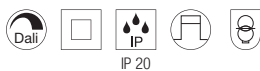

220-240V ~50/60Hz
L: 40 cm La: 4 cm H: 2,2 cm
Materiale: policarbonato (PC)

Tensione in uscita	24V DC
Potenza da	75W
Potenza fino a	250W
Fattore di potenza dell'apparecchio	0.95
Protezione termica	110°C
Numero di uscite secondarie	1

Versione	Articolo	EUR
<input type="radio"/> bianco	1007257	160,00

DRIVER LED DALI CCT 60W | 24V DALI Tunable white

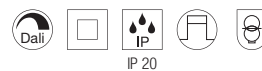

220-240V ~50/60Hz
L: 20,2 cm La: 5,8 cm H: 3 cm
Materiale: policarbonato (PC)

• 2 canali

Tensione in uscita	24V DC
Potenza da	5W
Potenza fino a	60W
Fattore di potenza dell'apparecchio	0.95
Protezione termica	110°C
Numero di uscite secondarie	2

Versione	Articolo	EUR
<input type="radio"/> bianco	1006133	153,00

DRIVER LED DALI
100W | 24V DALI Tunable white

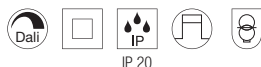

220-240V ~50/60Hz

• 2 canali
L: 34,7 cm La: 4 cm H: 2,2 cm
Materiale: policarbonato (PC)

Potenza da	5W
Potenza fino a	100W
Fattore di potenza dell'apparecchio	0.95
Protezione termica	110°C
Numero di uscite secondarie	2

Versione	Articolo	EUR
<input type="radio"/> bianco	1006134	184,00

DRIVER LED
10W | 200mA | PHASE

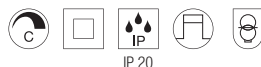

220-240V ~50/60Hz
L: 8,5 cm La: 4,1 cm H: 2,2 cm
Materiale: policarbonato (PC)

Tensione in uscita	30-42V DC
Potenza da	6W
Potenza fino a	8.4W
Fattore di potenza dell'apparecchio	0.9
Protezione termica	110°C
Numero di uscite secondarie	1

Versione	Articolo	EUR
<input type="radio"/> bianco	1007215	35,00

DRIVER LED
6W | 350mA | PHASE



220-240V ~50/60Hz
L: 6,3 cm La: 4 cm H: 2,3 cm
Materiale: policarbonato (PC)

Tensione in uscita	10-17V DC
Potenza da	3.5W
Potenza fino a	5.9W
Fattore di potenza dell'apparecchio	0.9
Protezione termica	110°C
Numero di uscite secondarie	1

Versione	Articolo	EUR
<input type="radio"/> bianco	1002791	28,50

DRIVER LED
20W | 350mA | PHASE

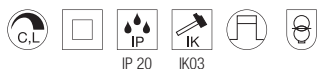

220-240V 0/~50/60Hz
L: 11,6 cm La: 4,1 cm H: 2,5 cm
Materiale: policarbonato (PC)

Tensione in uscita	28-50V DC
Potenza da	9.8W
Potenza fino a	17.5W
Fattore di potenza dell'apparecchio	0.95
Protezione termica	110°C
Numero di uscite secondarie	1

Versione	Articolo	EUR
<input type="radio"/> bianco	1007228	40,00

DRIVER LED
20W | 350mA/500mA | PHASE

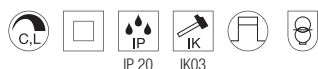

220-240V 0/~50/60Hz
L: 11,6 cm La: 4,1 cm H: 2,5 cm
Materiale: policarbonato (PC)

Tensione in uscita	10-30V DC
Potenza da	3.5W
Potenza fino a	15W
Fattore di potenza dell'apparecchio	0.95
Protezione termica	110°C
Numero di uscite secondarie	1

Versione	Articolo	EUR
<input type="radio"/> bianco	1007227	40,00

DRIVER LED
700mA | PHASE

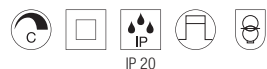

220-240V ~50/60Hz
L: 8,5 cm La: 4,1 cm H: 2,2 cm
Materiale: policarbonato (PC)

Tensione in uscita	8.6-12.9V DC
Potenza da	6W
Potenza fino a	9W
Fattore di potenza dell'apparecchio	0.9
Protezione termica	110°C
Numero di uscite secondarie	1

Versione	Articolo	EUR
<input type="radio"/> bianco	1007213	35,00

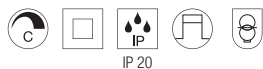
**DRIVER LED**
20W | 700mA | PHASE

200-240V ~50/60Hz
L: 11,5 cm La: 4,1 cm H: 2,5 cm
Materiale: policarbonato (PC)

Tensione in uscita	18-26V DC
Potenza da	12.6W
Potenza fino a	18.2W
Fattore di potenza dell'apparecchio	0.9
Protezione termica	110°C
Numero di uscite secondarie	1

Versione	Articolo	EUR
<input type="radio"/> bianco	1006202	34,00

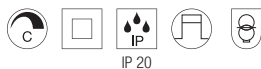
DRIVER LED
40W | 700mA | PHASE

200-240V ~50/60Hz
L: 14,5 cm La: 4 cm H: 3 cm
Materiale: policarbonato (PC)

Tensione in uscita	32-54V DC
Potenza da	22.4W
Potenza fino a	37.8W
Fattore di potenza dell'apparecchio	0.9
Protezione termica	110°C
Numero di uscite secondarie	1

Versione	Articolo	EUR
<input type="radio"/> bianco	1005446	45,00

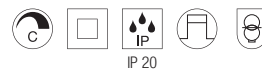
DRIVER LED
40W | 1050mA | PHASE

220-240V ~50/60Hz
L: 16,6 cm La: 5,2 cm H: 2,4 cm
Materiale: policarbonato (PC)

Tensione in uscita	22-43V DC
Potenza da	23W
Potenza fino a	45W
Fattore di potenza dell'apparecchio	0.95
Protezione termica	110°C
Numero di uscite secondarie	1

Versione	Articolo	EUR
<input type="radio"/> bianco	464804	57,00

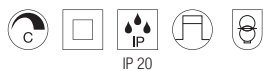
DRIVER LED
40W | 1000mA | PHASE

220-240V ~50/60Hz
L: 14,5 cm La: 4 cm H: 3 cm
Materiale: policarbonato (PC)

Tensione in uscita	25-40V DC
Potenza da	26.3W
Potenza fino a	42W
Fattore di potenza dell'apparecchio	0.9
Protezione termica	110°C
Numero di uscite secondarie	1

Versione	Articolo	EUR
<input type="radio"/> bianco	1005387	57,00

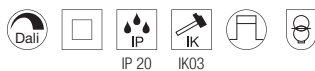
DRIVER LED DALI
25W | 150-700mA | Dimmerabile

220-240V 0/~50/60Hz
L: 11,9 cm La: 5,2 cm H: 2,25 cm
Materiale: policarbonato (PC)

Tensione in uscita	2-50V DC
Potenza da	0.3W
Potenza fino a	25W
Fattore di potenza dell'apparecchio	0.95
Protezione termica	110°C
Numero di uscite secondarie	1

Versione	Articolo	EUR
<input type="radio"/> bianco	1007229	70,00

DRIVER LED DALI
25W | 150-300mA | Dimmerabile

220-240V ~50/60Hz
L: 14,18 cm La: 4,38 cm H: 3 cm
Materiale: policarbonato (PC)

Tensione in uscita	10-40V DC
Potenza da	1.5W
Potenza fino a	12W
Fattore di potenza dell'apparecchio	0.9
Protezione termica	110°C
Numero di uscite secondarie	1

Versione	Articolo	EUR
<input type="radio"/> bianco	1006456	85,00

MODULO RF ZIGBEE per driver DALI



NEW



L: 4,3 cm La: 3,1 cm H: 1,2 cm
Materiale: policarbonato (PC)

- Zigbee 3.0 Single color

MODULO RF CASAMBI per driver DALI



NEW

L: 4,3 cm La: 3,1 cm H: 1,2 cm
Materiale: policarbonato (PC)

- Casambi

DRIVER LED DALI 12W | 500mA Predisposizione RF



NEW



220-240V ~50/60Hz
L: 14,18 cm La: 4,38 cm H: 3 cm
Materiale: policarbonato (PC)

Tensione in uscita	10-40V DC
Potenza da	1,5W
Potenza fino a	12W
Fattore di potenza dell'apparecchio	0,9
Protezione termica	110°C
Numero di uscite secondarie	1

Versione	Articolo	EUR
<input type="radio"/> bianco	1006199	38,00

Versione	Articolo	EUR
<input type="radio"/> bianco	1006454	129,00

Versione	Articolo	EUR
<input type="radio"/> bianco	1006194	85,00

DRIVER LED DALI 40W | 500mA Predisposizione RF



NEW



220-240V ~50/60Hz
L: 12,3 cm La: 7,9 cm H: 3 cm
Materiale: policarbonato (PC)

Tensione in uscita	10-42V DC
Potenza da	5W
Potenza fino a	42W
Fattore di potenza dell'apparecchio	0,95
Protezione termica	110°C
Numero di uscite secondarie	1

Versione	Articolo	EUR
<input type="radio"/> bianco	1006195	100,00

DRIVER LED DALI 40W | 700mA Predisposizione RF



NEW



220-240V ~50/60Hz
L: 12,3 cm La: 7,9 cm H: 3 cm
Materiale: policarbonato (PC)

Tensione in uscita	10-42V DC
Potenza da	5W
Potenza fino a	42W
Fattore di potenza dell'apparecchio	0,95
Protezione termica	110°C
Numero di uscite secondarie	1

Versione	Articolo	EUR
<input type="radio"/> bianco	1006196	100,00

DRIVER LED DALI 40W | 1050mA Predisposizione RF



NEW



220-240V ~50/60Hz
L: 12,3 cm La: 7,9 cm H: 3 cm
Materiale: policarbonato (PC)

Tensione in uscita	10-40V DC
Potenza da	5W
Potenza fino a	42W
Fattore di potenza dell'apparecchio	0,95
Protezione termica	110°C
Numero di uscite secondarie	1

Versione	Articolo	EUR
<input type="radio"/> bianco	1006197	100,00

**DRIVER LED DALI**
20W | 250-700mA 1-10V/DALI

220-240V ~50/60Hz
L: 15 cm La: 5,2 cm H: 2,8 cm
Materiale: policarbonato (PC)

Tensione in uscita	6-60V DC
Potenza da	1.5W
Potenza fino a	20W
Fattore di potenza dell'apparecchio	0.9
Protezione termica	110°C
Numero di uscite secondarie	1

Versione	Articolo	EUR
<input type="radio"/> bianco	1002423	85,00

DRIVER LED
40W | 500-1050mA 1-10V/DALI

220-240V ~50/60Hz
L: 12,3 cm La: 7,9 cm H: 2,4 cm
Materiale: policarbonato (PC)

Tensione in uscita	9-58V DC
Potenza da	4.5W
Potenza fino a	40W
Fattore di potenza dell'apparecchio	0.9
Protezione termica	110°C
Numero di uscite secondarie	1

Versione	Articolo	EUR
<input type="radio"/> bianco	1002424	90,00

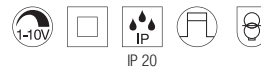
DRIVER LED
50W | 700-1500mA 1-10V/DALI

220-240V ~50/60Hz
L: 12,3 cm La: 7,9 cm H: 2,4 cm
Materiale: policarbonato (PC)

Tensione in uscita	6-58V DC
Potenza da	4.2W
Potenza fino a	50W
Fattore di potenza dell'apparecchio	0.9
Protezione termica	110°C
Numero di uscite secondarie	1

Versione	Articolo	EUR
<input type="radio"/> bianco	1002425	96,00

DRIVER LED DALI
40W | 1050mA DALI CCT tunable

NEW

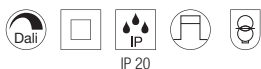

220-240V ~50/60Hz
L: 12,3 cm La: 7,9 cm H: 3 cm
Materiale: policarbonato (PC)

Tensione in uscita	10-40V DC
Potenza da	5W
Potenza fino a	42W
Fattore di potenza dell'apparecchio	0.9
Protezione termica	110°C
Numero di uscite secondarie	7

Versione	Articolo	EUR
<input type="radio"/> bianco	1006198	155,00

MODULO RF ZIGBEE
per driver DALI

NEW



L: 4,3 cm La: 3,1 cm H: 1,2 cm
Materiale: policarbonato (PC)

- Zigbee 3.0 Dual color (Tunable white)

Versione	Articolo	EUR
<input type="radio"/> bianco	1006455	38,00

DRIVER LED
10W | 250mA

220-240V ~50/60Hz
L: 6,5 cm La: 3,9 cm H: 2 cm
Materiale: policarbonato (PC)

Tensione in uscita	26-40V DC
Potenza da	6.5W
Potenza fino a	10W
Fattore di potenza dell'apparecchio	0.9
Protezione termica	110°C
Numero di uscite secondarie	1

Versione	Articolo	EUR
<input type="radio"/> bianco	1004780	26,00

DRIVER LED
3W | 350mA



100-240V ~50/60Hz
L: 6,5 cm La: 2,9 cm H: 1,8 cm
Materiale: policarbonato (PC)

Tensione in uscita	2,7-10V DC
Potenza da	1W
Potenza fino a	3,5W
Fattore di potenza dell'apparecchio	0,4
Protezione termica	110°C
Numero di uscite secondarie	1

Versione	Articolo	EUR
<input type="radio"/> bianco	1005248	15,00

DRIVER LED
3W | 350mA Connettore AMP

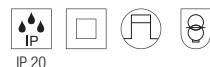

100-240V ~50/60Hz
L: 6,5 cm La: 2,9 cm H: 1,8 cm
Materiale: policarbonato (PC)

Tensione in uscita	2,7-10V DC
Potenza da	1W
Potenza fino a	3,5W
Fattore di potenza dell'apparecchio	0,4
Protezione termica	110°C
Numero di uscite secondarie	1

Versione	Articolo	EUR
<input type="radio"/> bianco	1007270	19,80

DRIVER LED
20W | 350mA



220-240V 0/~50/60Hz
L: 11,6 cm La: 4,1 cm H: 2,5 cm
Materiale: policarbonato (PC)

Tensione in uscita	2-54V DC
Potenza da	0,7W
Potenza fino a	19W
Fattore di potenza dell'apparecchio	0,95
Protezione termica	110°C
Numero di uscite secondarie	1

Versione	Articolo	EUR
<input type="radio"/> bianco	1007225	30,00

DRIVER LED
21W | 500mA



220-240V 0/~50/60Hz
L: 11,6 cm La: 4,1 cm H: 2,5 cm
Materiale: policarbonato (PC)

Tensione in uscita	2-42V DC
Potenza da	1W
Potenza fino a	21W
Fattore di potenza dell'apparecchio	0,95
Protezione termica	110°C
Numero di uscite secondarie	1

Versione	Articolo	EUR
<input type="radio"/> bianco	1007226	30,00

DRIVER LED
3W | 700mA

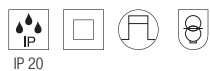

100-240V ~50/60Hz
L: 6,5 cm La: 2,9 cm H: 1,8 cm
Materiale: policarbonato (PC)

Tensione in uscita	2,7-4V DC
Potenza da	1,9W
Potenza fino a	2,8W
Fattore di potenza dell'apparecchio	0,4
Protezione termica	110°C
Numero di uscite secondarie	1

Versione	Articolo	EUR
<input type="radio"/> bianco	1007216	23,00

DRIVER LED
30W | 700mA



220-240V ~50/60Hz
L: 14,7 cm La: 4,3 cm H: 3 cm
Materiale: policarbonato (PC)

Tensione in uscita	30-42V DC
Potenza da	21W
Potenza fino a	29,5W
Fattore di potenza dell'apparecchio	0,9
Protezione termica	110°C
Numero di uscite secondarie	1

Versione	Articolo	EUR
<input type="radio"/> bianco	1004781	30,75

**DRIVER LED**
40W | 1050mA

220-240V ~50/60Hz
L: 14,7 cm La: 4,3 cm H: 3 cm
Materiale: policarbonato (PC)

Tensione in uscita	30-42V DC
Potenza da	31.5W
Potenza fino a	44W
Fattore di potenza dell'apparecchio	0.9
Protezione termica	110°C
Numero di uscite secondarie	1

Versione	Articolo	EUR
<input type="radio"/> bianco	1004782	36,00

DRIVER LED
40W | 700/900/1000mA

120-277V ~50/60Hz
L: 12,3 cm La: 7,9 cm H: 3 cm
Materiale: policarbonato (PC)

Tensione in uscita	28-52V DC
Potenza da	19.6W
Potenza fino a	40W
Fattore di potenza dell'apparecchio	0.9
Protezione termica	110°C
Numero di uscite secondarie	3

Versione	Articolo	EUR
<input type="radio"/> bianco	1006120	57,00



GANCIO PER SOFFITTO



L: 4,6 cm
 Ø: 1,8 cm
 Materiale: alluminio

Versione	Articolo	EUR
● nero	132670	19,20
○ bianco	132671	19,20

SERRACAVO



L: 3,1 cm
 Ø: 1,4 cm
 Materiale: alluminio

Versione	Articolo	EUR
● nero	132680	12,50
○ bianco	132681	12,50

GLENOS® Rosone



220-240V ~50/60Hz
 L: 8,5 cm La: 8,5 cm H: 2,7 cm
 Materiale: alluminio

Tensione nominale	220-240V ~50/60Hz
Corrente max.	8.5A

Versione	Articolo	EUR
● nero	210060	32,00
○ bianco	210061	32,00
● grigio	210064	32,00

CAVO IN TESSUTO 3 poli, 10m



L: 1000 cm
 Ø: 0,6 cm
 Materiale: Polivinilcloruro (PVC)/tessuto

Voltaggio max. 300V ACV

Versione	Articolo	EUR
● nero	961270	62,00

CAVO 3 poli, 3 x 0,75 mm², 10 m



L: 1000 cm

Voltaggio max. 300V ACV

Versione	Articolo	EUR
○ trasparente	961250	27,25

CAVO DI SOSPENSIONE IN ACCIAIO



L: 500 cm
 Ø: 0,15 cm
 Materiale: acciaio/plastica

Versione	Articolo	EUR
● argento	961037	20,50



STOPPER PER CAVO IN ACCIAIO

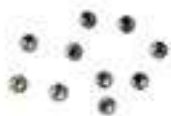

IP 20

Ø: 0,7 cm
Materiale: acciaio

PROLUNGA CAVI AMP



IP 20

L: 100 cm
Materiale: plastica

- Con connettori AMP

Corrente max. 0.35A

Versione	Articolo	EUR
● grigio	961034	29,00

Versione	Articolo	EUR
○ bianco	111861	7,75

PRESA MULTIPLA 3 uscite corrente costante



IP 20

L: 5,2 cm La: 1,4 cm H: 1,3 cm
Materiale: plastica

NASTRO BI-ADESIVO



L: 300 cm La: 0,9 cm

Corrente max. 0.35A

Versione	Articolo	EUR
● nero	111850	13,40

Versione	Articolo	EUR
○ trasparente	220000	15,00



1000735 699

GU10 LED CONNECTION BOX con attacco GU10 max 10 W

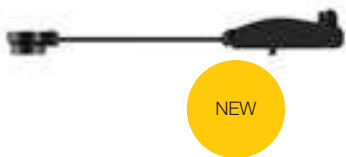

L: 3,8 cm La: 3,1 cm H: 1,7 cm
Materiale: plastica

GU10 CONNECTION BOX con attacco GU10



220-240V ~50/60Hz
L: 2,8 cm La: 2,8 cm H: 3,7 cm
Materiale: ceramica/plastica

- Lunghezza cavo 15 cm

ATTACCO GU10



230V ~50Hz
H: 1,6 cm
Ø: 2,8 cm
Materiale: ceramica

- Lunghezza cavo 15 cm

Tensione nominale 230V ~50Hz

Versione	Articolo	EUR
● nero	1007283 ●	6,00

Versione	Articolo	EUR
○● bianco/nero	1000909	7,75

Versione	Articolo	EUR
○ bianco	955135	2,05



CONNETTORE 3 POLI IP68, 3 poli



IP 68

230V ~50Hz

L: 11,5 cm

Ø: 2,7 cm

Materiale: poliammide (PA)

Tensione nominale	230V ~50Hz
Voltaggio max.	450V ACV
Corrente max.	17.5A

Versione	Articolo	EUR
● nero	228730	23,00

CONNETTORE A T 3 POLI IP68, 3 poli



IP 68

230V ~50Hz

L: 11 cm La: 6,4 cm H: 3 cm

Materiale: poliammide (PA)

Tensione nominale	230V ~50Hz
Voltaggio max.	500V DCV
Corrente max.	17.5A

Versione	Articolo	EUR
● nero	228726	36,00

CONNETTORE 5 POLI IP68, 5 poli, DALI



IP 68

230V ~50Hz

L: 13 cm

Ø: 3,2 cm

Materiale: poliammide (PA)

Tensione nominale	230V ~50Hz
Voltaggio max.	450V ACV
Corrente max.	32A

Versione	Articolo	EUR
● nero	228725	17,90

CONNETTORE A Y 5 POLI IP68, 5 poli, DALI



NEW



IP 68

450V







L: 18 cm La: 6,3 cm H: 3,3 cm

Materiale: poliammide 66 (PA 66)

Tensione nominale	450V
Corrente max.	16A

Versione	Articolo	EUR
● nero	1006453 ●	35,00

NUMINOS®





	Incassi	83 – 87, 91 – 93
	Lampade da parete e a plafone	99 – 101
	Lampade a plafone	103 – 105
	Sospensioni	106 – 109
	Binari trifase	110 – 113, 115
	Binario 48V	469 – 471
	Accessori	94 – 95

Oppure potete configurarli in tutta semplicità online all'indirizzo:
numinos.slv.com

NEW TRIA®

	Incassi	122 – 147
---	---------------	-----------





MEDO®

	Lampade da parete e a plafone	148 – 161
	Lampade a plafone	164 – 165
	Sospensioni	166 – 167
	Incassi	168 – 169

LALU®

	Sospensioni	176 – 183
---	-------------------	-----------

ONE®

	Sospensioni	186 – 191
	Lampade da parete e a plafone	192 – 193
	Binari trifase	194 – 195
	Lampade da tavolo e da terra	196 – 199

Nota: codice articolo a sette cifre da pagina 886

111000		117351	262	143021	495
111262	238			143022	495
111292	239	132000		143030	497
111362	145	132020	409	143031	497
111382	145	132021	409	143032	497
111850	879	132024	409	143040	497
111861	879	132600	279, 281, 283, 295, 305, 309, 318	143041	497
		132601	279, 281, 283, 295, 305, 307, 309	143042	497
112000		132605	279, 281, 283, 295, 305, 309	143050	497
112221	227	132610	295, 305	143051	497
112222	227	132611	295, 305	143052	497
112225	227	132660	296	143060	497
112242	234	132661	296	143061	497
112682	227	132662	296	143062	497
112692	227	132670	878	143070	497
112720	238	132671	878	143071	497
112721	238	132680	878	143072	497
112780	238, 239, 240	132681	878	143080	497
112781	238, 239, 240	132690	295	143081	497
112910	220	132691	295	143082	497
112911	220	132835	660	143090	497
				143091	497
113000		133000		143092	497
113140	219	133009	309	143100	497
113141	219	133019	309	143101	497
113150	219	133050	309	143102	497
113151	219	133060	309	143110	497
113160	220	133444	307	143111	497
113161	220	133481	314	143112	497
113170	221	133482	314	143120	279
113171	221	133489	314	143121	279
113262	238	133490	314	143124	279
113292	239	133840	167	143130	497
113492	145	133841	167	143131	497
113512	145	133850	167	143132	497
113540	145	133851	167	143151	497
113541	145			143152	497
113550	145	135000		143160	497
113830	145	135250	153, 157, 161, 165	143161	497
113840	145	135251	153, 157, 161, 165	143162	497
113841	145	135254	153, 157, 161, 165	143169	497
113890	141			143170	497, 499
113891	141	138000		143171	497, 499
113930	257	138981	868	143172	497, 499
113931	257	138982	868	143190	513
113940	257	138991	868	143191	513
113941	257	138992	868	143221	499
113970	141			143230	499
113971	141	139000		143231	499
113976	141	139004	483	143241	499
		139006	484	143251	499
114000		139024	482	143261	499
114420	245	139026	483	143271	499
114421	245	139030	482	143281	499
114426	245	139031	482	143350	521
114430	245	139040	483	143351	521
114431	245	139041	483	143354	521
114436	245	139050	483	143380	497
114440	246	139051	483	143381	497
114441	246	139060	484	143382	497
114450	247	139061	484	143390	513
114451	247	139070	486	143391	513
114480	232	139071	486	143392	513
114481	232	139072	486	143430	519
		139080	486	143431	519
115000		139081	486	143432	519
115510	214	139082	486	143440	519
115511	214	139090	487	143441	519
115520	214	139091	487	143442	519
115521	214	139092	487	143450	515
115530	214	139100	489	143451	515
115531	214	139101	489	143454	515
115540	215	139102	489	143540	520
115541	215	139120	491	143541	520
115550	215	139121	491	143544	520
115551	215	139122	491	143580	507
		139130	489	143581	507
117000		139131	489	143594	511
117100	265	139132	489	143621	511
117101	265			143731	520
117110	265	143000		143811	521
117111	265	143010	495	143930	512
117311	230	143011	495	143932	512
117321	262	143012	495	143941	516
117331	230	143020	495	143951	517

143960	517	151456	367	155530	312
143961	517	151511	263	155540	447
143990	509	151514	263	155550	266
143991	509	151531	263, 408	155551	266
144000		151534	263, 408	155582	267, 297, 449
144010	511	151591	373	155583	267, 297, 449
144011	511	151710	368	155592	267, 297, 449
144019	511	151711	368	155714	306
144200	515	151740	368	155752	375
144201	515	151741	368	155780	447
144204	515	151781	329	155790	447
		151786	329	155910	313
		151791	329	155930	313
		151796	329		
145000		151800	379	156000	
145990	279, 281, 283, 295, 305, 309	151801	379	156050	268
145994	279, 281, 283, 295, 305, 309	151803	379	156051	268
146000		151810	259	156100	297
146010	453	151811	259	156111	267, 297, 449
146332	389	151830	407	156113	267, 297, 449
146682	387	151831	407	156122	267, 297, 449
146692	387	151840	259, 379, 407	156141	296, 448
		151850	305	156143	296, 448
147000		151851	305	156152	296, 448
147301	405	151853	305		
147306	405	151950	242	158000	
147311	405	151952	242	158400	301
147316	405	151960	242	158410	303
147321	405	151962	242	158799	243
147326	405				
147360	411	152000		161000	
147361	411	152010	407	161271	231
147370	411	152011	407	161291	231
147371	411	152020	407	161461	272
147380	411	152021	407		
147381	411	152101	259	165000	
147441	415	152230	541	165358	319
147442	415	152231	541	165359	319
147443	415	152232	541	165390	317
147444	415	152240	541	165400	317
147529	373	152241	541	165410	317
147550	409	152242	541		
147551	409	152320	538	181000	
147559	409	152321	538	181530	485
		152330	399	181531	485
		152331	399	181532	485
148000		152340	383		
148001	271	152341	383	186000	
148002	271	152360	301	186300	485
148004	270	152370	303	186301	485
148005	271	152380	232	186302	485
148010	357	152381	232	186310	485
148012	361	152430	543	186311	485
148013	361	152431	543	186312	485
148016	361	152600	540	186330	485
148018	356	152601	540	186331	485
148019	359	152610	540	186332	485
148060	360	152611	540	186340	485
148070	233	152640	543	186341	485
148071	233	152641	543	186342	485
148091	359	152750	537	186350	485
148540	388	152751	537	186351	485
		152780	537	186352	485
149000		152781	537	186360	485
149381	305	152960	543	186361	485
149387	305	152961	543	186362	485
149388	305			186640	485
149452	381	153000		186641	485
149471	334	153130	536	186642	485
149511	334	153140	535		
149762	332	153141	535	210000	
149772	332	153420	537	210060	318, 878
		153421	537	210061	878
151000		153560	539	210064	878
151040	314	153561	539		
151041	314	153564	539	220000	
151049	314	153850	537	220000	879
151271	366	153851	537		
151275	366			227000	
151282	337	155156	273	227176	779
151320	362	155180	427	227195	768
151321	362	155236	427	227219	657
151410	367	155373	269	227220	657
151411	367	155490	448	227221	657
151450	367			227410	694
151451	367				

227418	694	229961	812	232195	676, 677
227462	848	229965	812	232285	781
227505	689	229971	813	232294	682
227600	854	229975	813	232295	682
227604	854			232431	755
227680	857	230000		232435	752
227684	857	230030	759	232441	753
227922	667, 668	230034	759	232445	753
		230044	746	232461	752
228000		230045	746	232465	752
228100	667	230060	631, 661, 671, 685	232485	773
228110	667	230061	671	232491	773
228130	667	230063	671	232495	773
228332	849	230066	671	232497	773
228342	849	230069	671	232531	741
228412	839	230084	747	232535	741
228430	845	230085	747	232537	741
228434	845	230090	642	232905	771
228555	699	230355	779	232915	771
228560	699	230365	765		
228712	653, 665, 685	230435	660	233000	
228722	653, 665	230444	746	233094	811
228725	881	230445	746	233095	811
228730	881	230465	659	233104	785
228752	685	230655	747	233105	785
228753	613, 659	230657	747	233114	764
228754	633, 637			233115	764
228771	761	231000		233134	783
228775	761	231010	758	233135	783
228776	761	231012	758	233145	685
228925	665	231015	758	233165	685
228935	665	231035	696	233185	685
228945	665	231072	693	233214	764, 783, 785
228960	663	231205	743	233215	764, 783, 785
228965	663	231215	637	233245	809
		231225	637	233255	809
229000		231230	633, 637, 640, 641	233302	761
229020	646	231231	681	233427	642
229021	646	231233	648, 649, 655, 669, 673	233437	643
229022	646, 647	231235	649	233447	640
229062	827	231305	681	233457	640
229071	815	231315	780	233500	840
229072	815	231351	762	233520	840
229075	815	231355	762	233540	847
229081	815	231370	649	233570	698
229085	815	231371	649	233571	698
229090	697	231410	647	233580	698
229110	825	231411	647	233582	698
229162	668	231420	648	233601	823
229172	668	231440	649	233605	823
229200	847	231455	675	233615	823
229230	846	231457	675	233621	823
229234	847	231475	672	233625	823
229320	843	231505	685	233635	822
229324	843	231515	808	233639	822
229374	843	231525	703	233650	825
229381	839	231535	703	233660	825
229383	839	231541	801	233792	849
229410	641	231545	801		
229411	641	231585	778	234000	
229420	643	231595	672	234505	736
229421	643	231805	768	234515	735
229422	642, 643, 645, 662	231807	768	234525	737
229430	645	231815	675	234535	797
229431	645	231817	675		
229432	645	231960	692	461000	
229524	736	231961	692	461060	868
229525	736			464804	873
229531	735	232000			
229532	735	232045	777	631000	
229535	735	232055	799	631337	433
229551	797	232065	659	631339	433
229554	797	232075	659		
229555	797	232085	659	900000	
229564	737	232101	775	900011	697, 698
229565	737	232105	775		
229574	735	232115	633	955000	
229575	735	232119	633	955135	880
229664	775	232125	633		
229665	775	232135	678	961000	
229702	827	232145	678	961034	879
229740	695	232155	676	961037	878
229741	697	232165	676	961250	878
229931	817	232175	677	961270	878
229935	817	232185	677		

1000100	
1000127	403
1000128	403
1000129	403
1000130	403
1000131	403
1000132	403
1000135	403
1000136	403

1000300	
1000327	377
1000329	377
1000330	377
1000332	801
1000333	767
1000334	767
1000335	781
1000336	779
1000339	801
1000340	767
1000342	767
1000343	673
1000344	673
1000345	673
1000346	673
1000384	849
1000398	659, 661

1000400	
1000422	365
1000423	365
1000458	567
1000459	567
1000461	567
1000462	567
1000464	567
1000465	567
1000466	569, 571
1000468	569, 571
1000469	569, 571
1000473	569
1000474	569
1000476	569
1000477	569
1000479	569
1000480	569
1000487	569
1000489	569
1000497	573
1000498	573

1000500	
1000523	573
1000524	573
1000525	573
1000533	573
1000534	573
1000535	575
1000536	575
1000540	574
1000546	574
1000549	574
1000557	575
1000558	575
1000560	574
1000561	574
1000566	574
1000567	574
1000571	574
1000574	239
1000575	239
1000576	238
1000577	238
1000579	267, 297, 449
1000580	267, 297, 449

1000600	
1000613	351
1000614	353
1000615	353
1000616	351
1000618	351
1000621	353
1000623	353

1000634	367
1000638	362
1000639	362
1000640	362
1000655	849
1000665	662
1000666	662
1000668	341
1000669	341
1000670	341
1000682	666
1000683	666
1000685	253
1000686	253
1000688	253
1000689	253
1000691	253
1000692	253
1000694	253
1000695	253

1000700	
1000702	405
1000703	405
1000704	405
1000711	516
1000712	517
1000713	511
1000714	228
1000715	228
1000716	228
1000717	228
1000718	228
1000719	228
1000720	228
1000721	228
1000726	165
1000729	379
1000730	379
1000735	699
1000736	699
1000763	448
1000773	296
1000777	339
1000780	339
1000783	274
1000784	274
1000785	274
1000786	274
1000797	780
1000799	684

1000800	
1000801	684
1000807	261
1000808	261
1000809	261, 306
1000810	261, 306
1000811	261, 306
1000812	261, 306
1000813	306
1000820	777
1000821	661
1000822	661
1000823	799
1000824	351
1000825	353
1000833	237
1000880	783
1000881	783
1000886	413
1000887	413
1000889	413
1000890	413
1000892	413
1000893	413
1000895	413
1000896	413

1000900	
1000909	880
1000910	377
1000911	377
1000914	218
1000915	218

1000917	218
1000926	293
1000927	293
1000929	293
1000930	293
1000932	293
1000933	293
1000935	293
1000936	293
1000957	297

1001000	
1001015	236
1001016	236
1001017	237
1001018	237
1001019	430
1001020	430

1001100	
1001165	235
1001166	235
1001167	235
1001168	235
1001169	235
1001171	235
1001172	235

1001200	
1001254	853
1001255	853
1001256	853
1001262	853
1001263	853
1001264	237
1001272	380
1001273	380
1001274	380
1001275	380
1001276	380
1001283	431
1001284	431
1001286	431
1001287	431
1001299	341

1001300	
1001300	341
1001303	341
1001304	341
1001309	293
1001310	293
1001314	817
1001359	853

1001400	
1001400	291
1001403	291
1001406	291
1001409	291
1001460	452
1001461	452
1001462	452
1001463	452
1001468	388
1001472	388
1001488	669
1001489	669
1001490	669
1001494	669

1001500	
1001505	275
1001506	275
1001508	275
1001509	275
1001542	279, 281, 283, 295, 305, 307
1001574	861
1001575	861

1001700	
1001701	312
1001800	
1001861	521
1001868	513

1001869	513	1002203	701	1002890	167
1001871	539	1002215	263, 408	1002891	167
1001872	539	1002216	263	1002893	841
1001900		1002218	868	1002895	841
1001901	170	1002221	869	1002897	841
1001902	170	1002228	335	1002898	841
1001903	170	1002229	335	1002899	841
1001905	171	1002238	357		
1001906	171	1002239	371	1002900	
1001907	171	1002240	371	1002900	721
1001930	234	1002400		1002902	721
1001931	234	1002402	745	1002903	807
1001939	272	1002403	745	1002904	807
1001950	153, 157, 161, 165	1002423	875	1002905	783
1001951	153, 157, 161, 165	1002424	875	1002906	631
1001952	153, 157, 161, 165	1002425	875	1002907	631
1001962	697	1002430	387	1002909	188
1001963	697	1002431	387	1002910	188
1001964	694	1002432	387	1002911	188
1001965	694	1002494	663	1002912	188
1001968	509			1002913	189
1001969	762	1002500		1002914	189
1001970	762	1002503	763	1002915	193
1001999	655	1002504	763	1002917	193
		1002505	763	1002918	193
1002000		1002583	453, 601	1002919	193
1002000	655	1002591	221	1002922	243
1002001	655	1002592	221	1002925	373
1002002	777	1002594	221	1002927	373
1002003	257			1002928	363
1002004	255	1002600		1002929	363
1002005	255	1002602	482	1002931	379
1002006	255	1002603	482	1002933	379
1002008	257	1002604	482	1002934	261
1002010	255	1002607	387	1002936	261
1002011	255	1002608	387	1002937	305
1002012	255	1002686	535	1002939	305
1002013	255	1002690	491	1002940	426
1002015	255	1002691	868	1002941	426
1002018	765	1002692	868	1002948	311
1002020	423	1002693	868	1002949	311
1002021	423	1002694	491	1002950	311
1002022	423	1002695	491	1002951	310
1002023	405	1002696	491	1002952	760
1002024	405	1002697	485	1002953	760
1002025	405	1002698	485	1002954	760
1002029	411	1002699	485	1002955	760
1002030	411			1002956	679
1002032	739	1002700		1002957	679
1002033	739	1002700	485	1002958	679
1002034	739	1002701	485	1002959	679
1002035	773	1002702	485	1002962	329
1002045	315	1002703	485	1002964	329
1002046	315	1002704	485	1002965	261
1002069	759	1002705	485	1002967	272
1002070	759	1002791	872	1002968	272
1002075	425			1002969	401
1002076	425	1002800		1002970	401
1002077	425	1002842	363	1002971	401
1002098	244	1002843	363	1002973	401
1002099	244	1002844	363	1002974	401
		1002845	497	1002975	401
1002100		1002853	723, 725, 727, 729, 730, 777	1002976	401
1002100	244	1002854	520	1002977	401
1002101	244	1002855	381	1002978	401
1002102	244	1002860	389	1002979	241
1002110	517	1002861	489	1002980	241
1002111	517	1002862	489	1002981	241
1002113	517	1002863	489	1002982	243
1002116	387	1002864	490	1002989	770
1002117	387	1002865	490	1002990	770
1002118	387	1002866	490	1002991	681
1002119	387	1002867	785	1002992	681
1002140	383	1002868	769		
1002151	495	1002869	769	1003000	
1002152	495	1002871	652	1003001	683
1002153	495	1002873	509	1003004	281
1002163	279, 281, 283, 295	1002874	509	1003005	281
1002190	333	1002875	509	1003006	281
1002191	333	1002876	535	1003007	281
1002192	333	1002877	535	1003008	223
		1002878	535	1003009	223
1002200		1002882	165	1003010	223
1002201	701	1002884	785	1003011	225
				1003012	225

1003013	225	1003508	339	1004737	591
1003014	419	1003518	811	1004738	376
1003015	419	1003519	811	1004739	376
1003016	419	1003530	290	1004740	370
1003017	417	1003532	290	1004741	370
1003018	417	1003535	651	1004742	370
1003019	417	1003536	650	1004743	370
1003029	448	1003537	651	1004744	281, 295, 309, 318
1003040	275	1003538	651	1004745	281, 295, 309
1003041	275	1003539	775	1004746	281, 295, 309
1003042	275			1004747	749
1003043	275	1004600		1004748	749
1003044	289	1004649	785	1004749	629
1003045	289	1004650	756	1004750	629
1003046	289	1004651	756	1004751	629
1003047	289	1004652	701	1004757	693
1003048	289	1004653	808	1004759	188
1003049	289	1004660	349	1004760	188
1003050	289	1004661	349	1004761	188
1003051	289	1004662	349	1004762	188
1003052	275	1004663	349	1004763	188
1003053	275	1004664	399	1004764	188
1003054	275	1004665	399	1004765	189
1003055	275	1004666	258	1004766	189
1003073	243	1004667	258	1004767	189
1003074	243	1004668	229	1004768	189
		1004669	229	1004769	194
1003100		1004670	355	1004770	194
1003104	870	1004671	355	1004771	194
1003105	871	1004674	295, 309	1004772	194
1003106	869	1004675	295, 309	1004773	296, 448
		1004676	295	1004774	267, 297, 449
1003300		1004677	797	1004775	267, 297, 449
1003316	369	1004678	757	1004780	875
1003317	369	1004679	757	1004781	876
		1004680	653	1004782	877
1003400		1004681	653	1004783	497
1003416	729	1004682	376	1004784	497
1003417	729	1004686	533	1004785	497
1003418	730	1004687	533		
1003419	730	1004688	533	1004800	
1003420	795	1004689	533	1004889	570
1003421	795	1004690	533	1004890	570
1003422	725	1004691	533	1004893	571
1003423	725	1004692	533	1004894	571
1003424	727	1004693	533	1004895	571
1003425	727	1004694	223	1004896	577
1003426	793	1004695	223	1004897	577
1003427	793	1004696	223	1004898	577
1003428	375	1004697	225	1004899	577
1003429	375	1004698	225		
1003430	375	1004699	225	1004900	
1003431	375			1004900	578
1003432	307	1004700		1004901	578
1003435	300	1004700	419	1004902	578
1003436	300	1004701	419	1004903	579
1003437	729	1004702	419	1004904	579
1003438	730	1004705	417	1004905	577
1003439	795	1004706	382	1004906	577
1003440	725	1004707	382	1004907	577
1003441	727	1004708	582	1004908	577
1003442	793	1004709	582	1004909	578
1003447	692	1004710	582	1004910	578
1003448	692	1004712	583	1004911	579
1003449	813	1004713	583	1004912	578
1003450	813	1004714	583	1004913	578
1003451	813	1004716	584	1004914	578
1003452	813	1004717	584	1004915	578
1003453	759	1004718	584	1004916	578
1003454	759	1004719	584	1004917	578
1003455	384	1004720	585	1004932	575
1003456	385	1004721	585	1004933	507
1003457	384	1004722	586	1004934	507
1003458	385	1004723	586	1004935	507
1003459	385	1004725	587	1004936	507
1003460	385	1004726	591	1004957	785
1003466	240	1004727	589	1004969	349
1003467	364	1004729	330	1004970	453
1003468	364	1004730	330	1004971	337
1003470	721	1004731	331		
1003479	792, 793, 795	1004732	359	1005000	
		1004733	356	1005075	862
1003500		1004734	591	1005076	862
1003506	339	1004735	591	1005077	862
1003507	339	1004736	591	1005078	862

1005079	862	1005315	862	1006195	874
1005080	862	1005316	862	1006196	874
1005081	862	1005317	864	1006197	874
1005082	862	1005318	864	1006198	875
1005083	862	1005381	869	1006199	874
1005085	420	1005387	873		
1005086	420	1005390	445	1006200	
1005087	421	1005391	445	1006202	873
1005088	421	1005392	445	1006268	719
1005089	814	1005394	445	1006270	719
1005090	814	1005395	288		
		1005396	288	1006300	
1005100		1005397	532	1006307	355
1005125	755	1005399	532	1006308	355
1005126	755			1006314	749
1005148	739	1005400		1006316	791
1005149	739	1005400	532	1006317	720
1005150	739	1005401	532	1006318	720
1005151	741	1005402	532	1006319	349, 720
1005153	741	1005407	217	1006321	861
1005154	741	1005408	217	1006326	691
1005155	741	1005410	217	1006327	792
1005156	741	1005415	217	1006328	723
1005157	741	1005416	217	1006329	723
1005177	188	1005418	217	1006336	870
1005178	189	1005423	217	1006343	445
		1005424	217	1006344	445
1005200		1005435	220	1006345	288
1005201	744	1005436	220	1006348	869
1005202	811	1005439	630	1006377	295
1005205	725, 727, 729, 730, 731, 793	1005440	630	1006378	295
1005206	725, 727, 729, 730, 731, 793	1005441	683	1006379	614, 615, 616, 617, 618, 619
1005207	725, 727, 729, 730, 731, 793	1005442	639	1006380	614, 615, 616, 617, 618, 619
1005214	318	1005443	751	1006381	614, 615, 616, 617, 618, 619
1005215	318	1005444	869	1006382	614, 615, 616, 617, 618, 619
1005216	318	1005445	869	1006383	616
1005217	318	1005446	171, 873	1006384	619
1005218	318			1006385	618
1005248	876	1006100		1006386	621
1005262	725, 727, 729, 730, 731	1006104	855	1006387	617
1005263	725, 727, 729, 730, 731	1006105	855	1006388	620
1005265	865	1006106	839	1006389	617
1005268	865	1006107	839	1006390	619
1005269	860	1006120	877	1006391	618
1005271	860	1006121	219	1006392	621
1005272	860	1006122	219	1006393	617
1005273	861	1006123	429	1006394	620
1005274	863	1006124	429	1006395	281
1005275	863	1006125	429	1006396	281
1005276	863	1006126	429	1006397	281
1005277	863	1006127	429	1006398	281
1005278	863	1006128	429	1006399	281
1005279	863	1006133	871		
1005280	863	1006134	872	1006400	
1005281	863	1006155	508	1006400	281
1005282	863	1006156	508	1006402	281
1005283	863	1006157	534	1006403	281
1005284	860	1006158	534	1006404	717
1005285	860	1006159	309, 508, 534	1006405	717
1005286	860	1006160	309, 508, 534	1006406	821
1005287	860	1006161	382	1006407	821
1005288	860	1006162	382	1006408	627
1005289	865	1006171	851	1006409	627
1005290	865	1006172	851	1006410	318
1005291	863	1006173	851	1006411	157
1005292	863	1006174	851	1006412	157
1005294	864	1006175	851	1006414	157
1005295	864	1006176	851	1006415	157
1005296	864	1006178	742	1006417	157
1005297	862	1006179	742	1006418	157
1005298	862	1006180	635	1006420	157
1005299	862	1006181	635	1006421	157
		1006182	635	1006423	395
1005300		1006183	743	1006424	395
1005301	864	1006184	637	1006425	397
1005302	864	1006185	191	1006426	397
1005303	864	1006186	191	1006427	397
1005305	865	1006187	191	1006428	397
1005307	865	1006188	191	1006429	397
1005308	865	1006189	191	1006430	397
1005310	865	1006190	191	1006431	285
1005311	861	1006191	691	1006432	285
1005312	861	1006192	691	1006433	285
1005313	863	1006193	691	1006434	285
1005314	863	1006194	874	1006435	285

1006436	285	1006633	475	1007250	870
1006437	285	1006634	475	1007251	870
1006438	285	1006635	475	1007252	870
1006439	397	1006636	475	1007253	870
1006440	397	1006639	477	1007254	871
1006441	347	1006640	477	1007255	871
1006442	347	1006641	477	1007256	871
1006443	347	1006642	477	1007257	871
1006444	347	1006645	477	1007270	876
1006445	505	1006646	477	1007271	208
1006446	505	1006647	477	1007272	208
1006449	285, 347, 395, 505	1006648	477	1007273	209
1006450	285, 347, 395, 505			1007274	209
1006451	285, 347, 395, 505	1007000		1007281	711
1006452	868	1007083	459, 463, 467	1007282	711
1006453	881	1007084	459, 463, 467	1007283	880
1006454	243, 874	1007090	207	1007284	150
1006455	875	1007091	207	1007285	150
1006456	873	1007092	207	1007286	152
		1007093	207	1007287	152
1006500		1007094	207	1007288	150
1006565	459, 463, 467	1007095	205	1007289	150
1006566	459, 463, 467	1007096	205	1007290	152
1006567	459, 463, 467	1007097	205	1007291	152
1006568	459, 463, 467	1007098	205	1007292	150
1006569	459, 463, 467	1007099	205	1007293	150
1006570	459, 463, 467			1007294	152
1006571	459, 463, 467	1007100		1007295	152
1006572	459, 463, 467	1007137	459, 463, 467	1007296	150
1006573	459, 463, 467	1007138	459, 463, 467	1007297	150
1006574	459, 463, 467	1007142	715	1007298	152
1006575	459	1007143	715	1007299	152
1006576	459	1007144	715		
1006577	459	1007145	715	1007300	
1006578	459	1007146	689	1007300	151
1006579	459	1007147	689	1007301	151
1006580	459	1007180	205	1007302	153
1006581	463	1007181	205	1007303	153
1006582	463	1007182	205	1007304	151
1006583	463	1007183	205	1007305	151
1006584	463	1007184	207	1007306	153
1006585	463	1007185	207	1007307	153
1006586	463	1007186	207	1007308	151
1006587	467	1007187	207	1007309	151
1006588	467	1007188	463, 467	1007310	153
1006589	467	1007189	463, 467	1007311	153
1006590	467	1007190	285, 347, 395, 505	1007312	151
1006591	467	1007191	207	1007313	151
1006592	467	1007192	205	1007314	153
1006593	459	1007193	205	1007315	153
1006594	459	1007194	207	1007316	161
1006595	463	1007195	831	1007317	161
1006596	463	1007196	831	1007318	161
1006597	467	1007197	831	1007319	161
1006598	467	1007198	831	1007320	161
1006599	459, 463, 467			1007321	161
		1007200		1007322	161
1006600		1007200	331	1007323	161
1006600	459, 463, 467	1007201	331	1007324	161
1006601	459, 463, 467	1007202	331	1007325	161
1006602	459, 463, 467	1007207	744	1007326	161
1006603	459, 463, 467	1007213	872	1007327	161
1006604	459, 463, 467	1007215	872	1007328	126
1006605	459, 463, 467	1007216	876	1007329	126
1006606	459, 463, 467	1007225	876	1007330	126
1006607	459, 463, 467	1007226	872	1007331	126
1006608	459, 463, 467	1007228	872	1007332	126
1006609	459, 463	1007229	873	1007333	126
1006610	467	1007230	861	1007334	126
1006611	459	1007231	861	1007335	126
1006612	459	1007232	614	1007336	126
1006613	459, 463, 467	1007233	614	1007337	126
1006614	459, 463, 467	1007234	615	1007338	126
1006615	473	1007235	615	1007339	126
1006616	473	1007236	714	1007340	126
1006617	473	1007237	613	1007341	126
1006618	473	1007238	835, 837	1007342	126
1006621	475	1007239	835, 837	1007343	126
1006622	475	1007240	835, 837	1007344	126
1006623	475	1007241	837	1007345	126
1006624	475	1007242	837	1007346	126
1006627	473	1007243	835	1007347	126
1006628	473	1007244	835	1007348	126
1006629	473	1007245	835	1007349	126
1006630	473	1007246	837	1007350	126

1007351	126	1007443	126	1007597	279, 505, 531
1007352	503	1007444	126	1007598	279
1007353	503	1007445	126	1007599	279
1007354	503	1007446	126		
1007355	529	1007447	126	1007600	
1007356	529	1007448	126	1007600	327
1007357	437, 597	1007449	126	1007601	327
1007358	437, 597	1007450	126	1007602	327
1007359	437, 597	1007451	126	1007603	327
1007360	437, 597	1007452	126	1007604	251
1007361	437, 597	1007453	126	1007605	251
1007362	437, 597	1007454	126	1007606	251
1007363	443	1007458	805	1007607	251
1007364	443	1007459	607	1007608	395
1007365	443	1007460	607	1007609	395
1007366	443	1007461	791	1007610	395
1007368	138	1007462	444	1007611	395
1007369	138	1007463	444	1007612	325
1007370	138	1007464	444	1007613	325
1007371	138	1007465	444	1007614	325
1007372	138	1007466	444	1007615	325
1007373	138	1007467	444	1007616	325
1007374	138	1007468	287	1007617	325
1007375	138	1007469	287	1007618	325
1007376	138	1007470	287	1007619	325
1007377	138	1007471	287	1007620	443
1007378	138	1007472	287	1007621	443
1007379	138	1007473	287	1007622	443
1007380	441, 601	1007488	126	1007623	443
1007381	124	1007489	126	1007624	139
1007382	124			1007625	139
1007383	124	1007500		1007626	139
1007384	124	1007511	805	1007627	139
1007385	134	1007512	609	1007628	139
1007386	134	1007513	609	1007629	139
1007387	134	1007521	178	1007630	126
1007388	134	1007522	178	1007631	126
1007389	134	1007523	178	1007632	126
1007390	134	1007524	178	1007633	126
1007391	134	1007525	178	1007634	126
1007392	134	1007526	178	1007635	126
1007393	134	1007527	178	1007636	126
1007394	134	1007528	178	1007637	126
1007395	134	1007529	178	1007638	501
1007396	134	1007530	178	1007639	501
1007397	134	1007531	178	1007640	501
1007398	134	1007532	178	1007641	503
1007399	134	1007533	178	1007642	503
		1007534	178	1007643	503
1007400		1007535	178	1007644	527
1007400	134	1007536	178	1007645	527
1007401	137	1007537	178	1007646	527
1007402	137	1007538	178	1007647	527
1007403	137	1007539	178	1007648	529
1007404	137	1007540	178	1007649	529
1007405	135	1007541	178	1007651	603
1007406	135	1007542	178	1007652	603
1007407	135	1007543	178	1007653	805
1007408	135	1007544	178	1007654	525
1007409	125	1007545	178	1007655	525
1007410	125	1007546	178	1007656	525
1007411	125	1007547	178	1007657	525
1007412	125	1007551	213	1007667	713
1007421	124	1007552	213	1007668	713
1007422	124	1007559	213	1007669	611
1007423	135	1007560	213	1007670	611
1007424	135	1007567	213	1007673	501
1007425	135	1007568	213	1007674	501
1007426	135	1007580	605	1007680	833
1007427	135	1007581	709	1007681	833
1007428	135	1007582	789	1007682	833
1007429	135	1007583	605	1007683	833
1007430	135	1007584	605	1007684	833
1007431	125	1007585	709	1007685	833
1007432	125	1007586	789	1007692	439, 599
1007433	136	1007587	605	1007693	439, 599
1007434	136	1007588	279	1007694	439, 599
1007435	136	1007589	279	1007695	439, 599
1007436	136	1007590	393	1007696	439, 599
1007437	136	1007591	393	1007697	439, 599
1007438	136	1007592	393		
1007439	137	1007593	393		
1007440	137	1007594	345		
1007441	137	1007595	345		
1007442	137	1007596	279, 505, 531		

SIGHT MOVE
1004690



BINARIO MONOFASE

BINARIO SUPERFICIE MONOFASE _____ 495
 ACCESSORI BINARIO SUPERFICIE MONOFASE _____ 497
 BINARIO INCASSO MONOFASE _____ 499
 ACCESSORI BINARIO INCASSO MONOFASE _____ 499

BINARIO TRIFASE

EUTRAC® BINARIO SUPERFICIE TRIFASE _____ 537
 EUTRAC® ACCESSORI BINARIO SUPERFICIE TRIFASE _____ 539
 EUTRAC® BINARIO INCASSO TRIFASE _____ 541
 EUTRAC® ACCESSORI BINARIO INCASSO TRIFASE _____ 541
 S-TRACK BINARIO SUPERFICIE TRIFASE DALI _____ 529
 S-TRACK ACCESSORI BINARIO SUPERFICIE TRIFASE DALI _____ 530-531
 S-TRACK BINARIO INCASSO TRIFASE DALI _____ 533
 S-TRACK ACCESSORI BINARIO INCASSO TRIFASE DALI _____ 535

BINARIO 48V

48V BINARIO SUPERFICIE STANDARD DALI _____ 457
 48V ACCESSORI BINARIO SUPERFICIE STANDARD DALI _____ 459
 48V BINARIO SUPERFICIE ALTO DALI _____ 461
 48V ACCESSORI BINARIO SUPERFICIE ALTO DALI _____ 463
 48V BINARIO INCASSO DALI _____ 465
 48V ACCESSORI BINARIO INCASSO DALI _____ 467

A

ABRIDOR 100 POLE _____ 681
 ABRIDOR 60 POLE _____ 681
 ABRIDOR SENSOR WL _____ 770
 ABRIDOR WL _____ 770

ACCESSORI

ALIMENTATORE LED 100W | 24V | 2 CANALI DALI DIMMERABILE _____ 872
 ALIMENTATORE LED 100W | 24V DC _____ 871
 ALIMENTATORE LED 15W | 12V _____ 869
 ALIMENTATORE LED 15W | 24V _____ 869
 ALIMENTATORE LED 20W | 12/24V _____ 869
 ALIMENTATORE LED 25W | 24V _____ 870
 ALIMENTATORE LED 50W | 24V _____ 870
 ALIMENTATORE LED 60W | DALI, 24V, 2 CANALI DALI DIMMERABILE _____ 871
 ARRESTO PER CAVO IN ACCIAIO _____ 879
 ATTACCO GU10 _____ 880
 CAVO DI SOSPENSIONE IN ACCIAIO _____ 878
 CAVO IN TESSUTO TRIPOLARE, 10 M _____ 878
 CONNECTION BOX IP68, 5 POLI, DALI _____ 881
 CONTROLLER LED STIP CCT / RGBW _____ 869
 CONVERTITORE PHASE DIM -> DALI _____ 868
 DALI CONTROLLER 24V DC _____ 869
 DALI INTERFACE 1-10V + ON/OFF _____ 868
 DALI UNIVERSAL DIMMER 10-300W _____ 869
 DRIVER LED 100W | 24V DC CON SERRACAVO _____ 870
 DRIVER LED 100W | 24V DC DALI DIMMERABILE CON SERRACAVO _____ 871
 DRIVER LED 10W | 200MA | DIMMERABILE CON SERRACAVO _____ 872
 DRIVER LED 10W | 250MA _____ 875
 DRIVER LED 12W | 250MA DALI DIMMERABILE CON INTERFACCIA RF _____ 874
 DRIVER LED 150W | 24V DC CON SERRACAVO _____ 870
 DRIVER LED 150W | 24V DC DALI DIMMERABILE CON SERRACAVO _____ 871
 DRIVER LED 20W | 250-700MA 1-10V/ DALI DIMMERABILE _____ 875
 DRIVER LED 20W | 350MA | DIMMBAR _____ 872
 DRIVER LED 20W | 350MA _____ 876
 DRIVER LED 20W | 350MA/500MA | PHASE _____ 872
 DRIVER LED 20W | 700MA | DIMMERABILE _____ 873
 DRIVER LED 21W | 500MA CON SERRACAVO _____ 876
 DRIVER LED 250W | 24V DC CON SERRACAVO _____ 870
 DRIVER LED 250W | 24V DC DALI DIMMERABILE CON SERRACAVO _____ 871

DRIVER LED 25W | 150-300MA | DALI DIMMERABILE _____ 873
 DRIVER LED 25W | 150-700MA | DALI DIMMERABILE _____ 873
 DRIVER LED 30W | 24V DC CON SERRACAVO _____ 870
 DRIVER LED 30W | 24V DC DALI DIMMERABILE CON SERRACAVO _____ 871
 DRIVER LED 30W | 700MA _____ 876
 DRIVER LED 3W | 350MA _____ 876
 DRIVER LED 3W | 350MA PRESA AMP INCLUSA _____ 876
 DRIVER LED 3W | 700MA CON SERRACAVO _____ 876
 DRIVER LED 40W | 1000MA | DIMMERABILE _____ 873
 DRIVER LED 40W | 1050MA | DIMMERABILE _____ 873
 DRIVER LED 40W | 1050MA _____ 877
 DRIVER LED 40W | 1050MA DALI _____ 875
 CCT TUNABLE _____ 875
 DRIVER LED 40W | 500-1050MA 1-10V/ DALI DIMMERABILE _____ 875
 DRIVER LED 40W | 500MA DALI DIMMERABILE CON INTERFACCIA RF _____ 874
 DRIVER LED 40W | 700/900/1000MA _____ 877
 DRIVER LED 40W | 700MA | DIMMERABILE _____ 873
 DRIVER LED 40W | 700MA DALI DIMMERABILE CON INTERFACCIA RF _____ 874
 DRIVER LED 50W | 700-1500MA 1-10V/ DALI DIMMERABILE _____ 875
 DRIVER LED 6W | 350MA | DIMMERABILE _____ 872
 DRIVER LED 700MA | PHASE _____ 872
 DRIVER LED, 40W | 1050MA DALI DIMMERABILE CON INTERFACCIA RF _____ 874
 GANCI PER SOFFITTO _____ 878
 GLENOS® ROSENA A PLAFONE _____ 878
 GU10 CONNECTION BOX CON ATTACCO UNIVERSALE _____ 880
 GU10 LED CONNECTION BOX CON ATTACCO MAX. 10W _____ 880
 MODULO RF PER DRIVER DALI _____ 874, 875
 NASTRO BI-ADESIVO _____ 879
 PRESA MULTIPLA A 3 USCITE _____ 879
 PROLUNGA CAVI _____ 879
 SCATOLA DI COLLEGAMENTO IP 68, 3 POLI _____ 881
 SCATOLA DI COLLEGAMENTO IP68 A T, 3-POLI _____ 881
 SCATOLA DI COLLEGAMENTO IP68, 5-POLI _____ 881
 SERRACAVO _____ 878
 TRASFORMATORE 60VA | 12V AC _____ 868
 TRASFORMATORE TENSEO 12V AC | 105VA CONVENZIONALE _____ 868
 TRASFORMATORE TENSEO 12V AC | 210VA CONVENZIONALE _____ 868
 TRASFORMATORE TENSEO 12V AC | 50VA CONVENZIONALE _____ 868
 ADEGAN FL, E27 _____ 663
 ADEGAN MANILA FL, E27 _____ 663
 ADI EL _____ 822
 AINOS CW _____ 812
 AINOS CW SENSOR _____ 813
 AINOS CW SENSOR, QUADRATO _____ 813
 AINOS CW, QUADRATO _____ 813
 AKALO D83 EL _____ 237
 ALPA CONE 100 POLE, E27 _____ 665
 ALPA MUSHROOM 45 POLE, E27 _____ 665
 ALPA MUSHROOM 75 POLE, E27 _____ 665
 ALTRA DICE CL, QPAR51 _____ 263
 ALTRA DICE CW, DOUBLE, QPAR51 _____ 263, 408
 ALTRA DICE TRACK MONOFASE, QPAR51 _____ 521
 ALTRA DICE TRACK TRIFASE, QPAR51 _____ 556
 ANDREAS WL, QT-DE12 _____ 373
 ANELA CL, PHASE _____ 261
 ANELA PD, PHASE _____ 306
 ANGOLUX SENSOR WL _____ 762
 ANGOLUX WL _____ 762
 APONI 120 POLE, PHASE _____ 666
 APONI 90 POLE, PHASE _____ 666
 ARLINA 130 WL _____ 371
 ARLINA 60 WL _____ 371
 ARROCK ARC POLE, QPAR51 _____ 648
 ARROCK GRANITE 40 POLE, SQUARE, E27 _____ 647
 ARROCK GRANITE 70 POLE, SQUARE, E27 _____ 647

ARROCK SLOT POLE, QPAR51 _____ 649
 ARROCK STONE 50 POLE _____ 649
 ARROCK STONE 75 POLE _____ 649
 ASMARA LV, QR-C51 _____ 486
 ASSO 300 WL, PHASE _____ 366, 367
 ASTINA CL, QPAR51 _____ 261
 ASTINA PD, QPAR51 _____ 305
 ASTINA STEEL WL, QPAR51 _____ 761
 ASTINA UP/DOWN WL, QPAR51 _____ 379
 ASTINA WL, QPAR51 _____ 761
 ASTO CW, DOUBLE, QPAR51 _____ 415
 ASTO CW, QUAD, QPAR51 _____ 415
 ASTO CW, SINGLE, QPAR51 _____ 415
 ASTO CW, TRIPLE, QPAR51 _____ 415
 ASTO TUBE MONOFASE, GU10 _____ 505
 ASTO TUBE CL, SINGLE, GU10 _____ 395
 ASTO TUBE CW, DOUBLE, GU10 _____ 397
 ASTO TUBE CW, QUADRUPLE, GU10 _____ 397
 ASTO TUBE CW, SINGLE, GU10 _____ 397
 ASTO TUBE CW, TRIPLE, GU10 _____ 397
 ASTO TUBE RIFLETTORE DECORATIVO _____ 285, 395, 505
 ASTO TUBE PD, DOUBLE, GU 10 _____ 285
 ASTO TUBE PD, QUADRUPLE, GU 10 _____ 285
 ASTO TUBE PD, SINGLE, GU 10 _____ 285
 ASTO TUBE PD, TRIPLE, GU 10 _____ 285
 ASTO TUBE WL, SINGLE, GU10 _____ 347
 ASTO TUBE WL, UP/DOWN, GU10 _____ 347
 AVO CW, DOUBLE, QPAR51 _____ 413
 AVO CW, QUAD, QPAR51 _____ 413
 AVO CW, SINGLE, QPAR51 _____ 413
 AVO CW, TRIPLE, QPAR51 _____ 413
 AVO TRACK MONOFASE, QPAR51 _____ 515
 AVO TRACK TRIFASE, QPAR51 _____ 561

B

BASKET WL, E27 _____ 373
 BATTEN 120 CW _____ 429
 BATTEN 60 CW _____ 429
 BENA 120 CW _____ 433
 BENA 150 CW _____ 433
 BIG NAILS 50 POLE, E27 _____ 668
 BIG NAILS 80 POLE, E27 _____ 668
 BIG NAUTILUS SP, ROTONDO, QPAR51 _____ 694
 BIG PLOT COPERTURA, 3 PZ _____ 853
 BIG PLOT COPERTURA, 2 PZ _____ 853
 BIG PLOT MODULI _____ 853
 BIG QUAD UP/DOWN WL _____ 755
 BIG QUAD WL _____ 752, 755
 BIG THEO CL _____ 797
 BIG THEO CL, QPAR111 _____ 797
 BIG THEO UP/DOWN WL, QPAR111 _____ 735
 BIG THEO WL _____ 737
 BIG THEO WL, QPAR111 _____ 737
 BIMA MONOFASE, DOUBLE, QPAR51 _____ 519
 BIMA MONOFASE, SINGLE, QPAR51 _____ 519
 BIMA TRIFASE, DOUBLE, QPAR51 _____ 559
 BIMA TRIFASE, SINGLE, QPAR51 _____ 559
 BOOKAT POLE _____ 683
 BOOKAT WL _____ 751
 BOX UP/DOWN WL, QT-DE12 _____ 773
 BOX-L WL _____ 773
 BOX-L WL, E27 _____ 773
 BRICK DOWNUNDER EL _____ 827
 BRICK DOWNUNDER EL, E14 _____ 827
 BRICK EL, ASIMMETRICO _____ 825
 BRICK EL, SIMMETRICO _____ 825
 BRICK MESH EL _____ 825
 BULAN CW, E14 _____ 815
 BULAN GRID CW, E27 _____ 815

C

C-POL POLE, E27 _____ 672
 CARISO WL, PHASE _____ 368
 CHROMBO WL, PHASE _____ 369
 COMET LED LV _____ 491
 COMET LV, QR-C51 _____ 491
 CONCRETO EL, CUT _____ 821
 CONCRETO EL, WING _____ 821
 CONCRETO FL, QUADRATO, QPAR51 _____ 627
 CONCRETO FL, ROTONDO, QPAR 51 _____ 627
 CONCRETO L WL _____ 717
 CONCRETO M WL _____ 717
 CONE FL, E27 _____ 660
 COSMIC LV, QR-C51 _____ 487

COUPA FLEX WL	381
CUBIX FL, QPAR51	660
CYFT CW	395

D	
DASAR® 115 RL, QUADRATO, QPAR51	843
DASAR® 115 RL, RUND, QPAR51	843
DASAR® 1200 EL	831
DASAR® 215 RL, QUADRATO, QPAR111	847
DASAR® 215 RL, ROTONDO, E27	847
DASAR® 215 RL, ROTONDO, QPAR111	846
DASAR® 255 EL	839
DASAR® 270 EL, ASIMMETRICO	841
DASAR® 270 EL, SIMMETRICO	841
DASAR® 370 EL, ROTONDO	847
DASAR® 600 EL	831
DASAR® 920 EL	840
DASAR® 920 SP, 230V	698
DASAR® EXACT 116 EL, QUADRATO, QPAR51	845
DASAR® EXACT 116 EL, ROTONDO, QPAR51	845
DASAR® FLAT 120 EL	839
DASAR® FLAT 80 EL	839
DASAR® L RL, QUADRATO	835
DASAR® L RL, ROTONDO	835
DASAR® PROJECTOR SP, 12/24V	698
DASAR® S RL, QUADRATO	833
DASAR® S RL, ROTONDO	833
DASAR® XL RL, QUADRATO	837
DASAR® XL RL, ROTONDO	837
DEKLED EL	234
DELWA WL	767
DENA 30 WL, E14	373
DIO FLEX PLATE WL	387
DIO FLEX PLATE WL, QPAR51	387
DIRETO 60 WL, PHASE	370
DIRETO 90 WL, PHASE	370
DISPLAY ADL 50 QPAR51	389
DL 126 EL	227
DORISA 30 WL	339
DORISA 50 WL	339
DOWNUNDER OUT L EL	823
DOWNUNDER OUT M EL	823
DOWNUNDER OUT S EL	823
DOWNUNDER OUT WL, QUADRATO	769
DOWNUNDER OUT WL, ROTONDO	769
DOWNUNDER PUR 150 EL	242
DOWNUNDER PUR 80 EL	242
DURNO LV	489

E	
ENOLA B CL, QPAR51	259
ENOLA B CW, DOUBLE, QPAR51	407
ENOLA B CW, SINGLE, QPAR51	407
ENOLA B PD, QPAR51	305, 517
ENOLA B TRACK MONOFASE, QPAR51	517
ENOLA B WL, QPAR51	379
ENOLA C CL	259
ENOLA C TRACK MONOFASE	517
ENOLA C TRACK MONOFASE	516
ENOLA C TRACK TRIFASE	561
ENOLA M LENTE ASIMMETRICA	731
ENOLA M LENTE DA 19°	731
ENOLA OCULUS CL	792
ENOLA OCULUS WL, SINGLE	723
ENOLA OCULUS WL, UP/DOWN	723
ENOLA PD, E27	305
ENOLA ROUND L CL	793
ENOLA ROUND L WL, SINGLE	725
ENOLA ROUND M CL	793
ENOLA ROUND M WL, SINGLE	725
ENOLA ROUND S CL	793
ENOLA ROUND S WL, SINGLE	725
ENOLA S, M, L RIFLETTORE, 56°	731
ENOLA SQUARE L CL	795
ENOLA SQUARE L WL, SINGLE	729
ENOLA SQUARE M CL	795
ENOLA SQUARE M WL, SINGLE	729
ENOLA SQUARE S CL	795
ENOLA SQUARE S WL, SINGLE	729
ESKINA 30 POLE	631
ESKINA 80 POLE	631
ESKINA D DISPLAY, PHASE	783

ESKINA FRAME 125 POLE, DOUBLE	630
ESKINA FRAME 175 POLE, DOUBLE	630
ESKINA FRAME 45 POLE, SINGLE	629
ESKINA FRAME 75 POLE, DOUBLE	629
ESKINA FRAME 75 POLE, SINGLE	629
ESKINA FRAME CL, SINGLE	791
ESKINA FRAME WL	749
ESKINA FRAME WL, DOUBLE	749
ESKINA SPOT CW, PHASE	807
ESKINA SPOT SENSOR CW, PHASE	807
EURO CUBE TRIFASE	555
EURO SPOT TRACK MONOFASE, QPAR51	521
EURO SPOT TRACK TRIFASE, QPAR111	555
EURO SPOT TRACK TRIFASE, QPAR51	555

F	
F-POL POLE, E27	672
F-POL WL, E27	778
FENDA 15 CM, ROTONDO	448
FENDA 30 CM, ROTONDO	449
FENDA BOW BASIS FL, E27	448
FENDA FL, E27	447, 448
FENDA Ø 45 CM, ROTONDO	449
FENDA Ø 70 CM, ROTONDO	449
FENDA PD, E27	296
FENDA TL, E27	447
FERA 25 CL	272
FERA 25 CL, DALI	272
FITU CUBE WL, E27	376
FITU PD, E27	295
FLAC BEAM® SP	693
FLATT 100 POLE	679
FLATT 65 POLE	679
FLATT SENSOR WL	760
FLATT WL	760
FLOODI L SP	691
FLOODI M SP	691
FLOODI S SP	691
FORCHINI 50 PD, E27	312
FORCHINI 70 PD, E27	312
FORCHINI M 40 PD, E27	313
FORCHINI M 40 TRACK MONOFASE, E27	512
FORCHINI M 40 TRACK TRIFASE, PD, E27	554
FORCHINI M 50 PD, E27	313
FRAME BASIC	238
FRAME BASIC RL, HV	238
FRAME BASIC SET RL	238
FRAME CURVE EL	239

G	
GALEN 120 SP	692
GALEN 60 SP	692
GIMBLE OUT EL	849
GLENOS® 60 WL	339
GLENOS® PD, 1M, 1-10V	291
GLENOS® PD, 2M, 1-10V	291
GLOO PURE 27 POLE, E27	655
GLOO PURE 44 POLE, E27	655
GLOO PURE 70 POLE, E27	655
GLOO PURE WL, E27	777
GRAFIT 30 POLE, E27	637
GRAFIT 30 POLE, ROTONDO, E27	635
GRAFIT 60 POLE, E27	637
GRAFIT 60 POLE, ROTONDO, E27	635
GRAFIT 90 POLE, E27	637
GRAFIT 90 POLE, ROTONDO, E27	635
GRAFIT WL, E27	743
GRAFIT WL, QUADRATO, SENSORE, E27	743
GRAFIT WL, ROTONDO, E27	742
GRAFIT WL, ROTONDO, SENSORE, E27	742
GRAZIA FLEXSTRIP LED 24V	582
GRAZIA IP FLEXSTRIP 24V	591
GRAZIA IP FLEXSTRIP RGBW, 24V	591
GRAZIA IP FLEXSTRIP TUNABLE WHITE, 24V	591
GRAZIA PRO FLEXSTRIP 24V	583, 584
GRAZIA PRO FLEXSTRIP RGBW, 24V	589
GRAZIA PRO FLEXSTRIP TUNABLE WHITE, 24V	587
GRAZIA PRO MAX FLEXSTRIP 24V	585, 586
GRAZIA 10 PROFILO A PARETE/PLAFONE, PIATTO 2M	567
GRAZIA 10 PROFILO A PARETE/PLAFONE STANDARD	567
GRAZIA 10 ACCESSORI	569

GRAZIA 10 EDGE 2 M	570
GRAZIA 10 PROFILO DA INCASSO	567
GRAZIA 10 EDGE ACCESSORI	571
GRAZIA 20 PROFILO A PARETE/PLAFONE PIATTO, 3 M	573
GRAZIA 20 PROFILO A PARETE/PLAFONE STANDARD, 3 M	573
GRAZIA 20 PROFILO DA INCASSO 3 M	573
GRAZIA 20 ACCESSORI	574, 575
GRAZIA 60 PROFILO A PARETE/PLAFONE	577
GRAZIA 60 PROFILO DA INCASSO	577
GRAZIA 60 ACCESSORI	578, 579

H	
H-POL 30 POLE	676
H-POL 60 POLE	676
H-POL TWIN 30 POLE	677
H-POL TWIN 60 POLE	677
HELIA 30 PD	301
HELIA 30 PD, PHASE	301
HELIA 40 PD	303
HELIA 40 PD, PHASE	303
HELIA 50 TRACK MONOFASE	507
HELIA 50 TRACK TRIFASE	561
HELIA AMBIENT 35 PD	300
HELIA AMBIENT 35 PD, PHASE	300
HELIA CW, DOUBLE, PHASE	809
HELIA CW, SINGLE, PHASE	809
HELIA SPOT L SP, SINGLE, PHASE	699
HELIA SPOT S SP, SINGLE	699
HORN DL, DOUBLE, QPAR51	219
HORN DL, SINGLE, QPAR51	219, 220
HORN EL, SINGLE, QPAR51	220
HORN MAGNA EL	221
HORN MINI EL	218
HORN-T EL, QPAR111	221

I	
I-PENDANT PRO PD, 1195X295MM, DALI	289
I-RING POLE	613
I-RING WL	714
IMPERVA 120 CW	817
IN-LINE 22 48V, DARKLIGHT REFLECTOR, DALI	473
IN-LINE 22 48V, OPAL, DALI	473
IN-LINE 24 48V, MOVE, OPAL, DALI	477
IN-LINE 44 48V, DARKLIGHT REFLECTOR, DALI	475
IN-LINE 44 48V, OPAL, DALI	475
IN-LINE 46 48V, MOVE, DARKLIGHT REFLECTOR, DALI	477
INDA CW, QPAR51	409
IPERI 50 POLE	681
IPERI WL	780

K	
KADUX DL, DOUBLE, PHASE	213
KADUX DL, SINGLE, PHASE	213
KADUX DL, TRIPLE, PHASE	213
KADUX EL, DOUBLE, QPAR111	215
KADUX EL, DOUBLE, QPAR51	214
KADUX EL, SINGLE, QPAR111	215
KADUX EL, SINGLE, QPAR51	214
KADUX EL, TRIPLE, QPAR51	214
KALU CW, DOUBLE, PHASE	403
KALU CW, DOUBLE, QPAR111	405
KALU CW, QUAD, PHASE	403
KALU CW, QUAD, QPAR111	405
KALU CW, SINGLE, PHASE	403
KALU CW, SINGLE, QPAR111	405
KALU CW, TRIPLE, PHASE	403
KALU CW, TRIPLE, QPAR111	405
KALU TRACK MONOFASE, PHASE	520
KALU TRACK MONOFASE, QPAR111	520
KALU TRACK TRIFASE, QPAR111	558
KALU TRACK LED TRIFASE, PHASE	558
KARPO 30 CW, SINGLE	399
KARPO 30 EL	232
KARPO 30 WL, SINGLE	383
KARPO FL	452
KARPO GOOSE WL	382
KARPO MAGN CW, SINGLE, PHASE	382
KARPO TL	452
KARPO WL	383

KENKUA SPOT WL, E27 _____ 381
 KERAS ELT WL, E27 _____ 779
 KINI EL, PHASE _____ 237

L

L-LINE 120 WL _____ 341
 L-LINE 60 WL _____ 341
 L-LINE OUT 30 FL, VERTICALE _____ 650
 L-LINE OUT 50 POLE, ORIZZONTALE _____ 651
 L-LINE OUT 60 FL, VERTICALE _____ 651
 L-LINE OUT 80 POLE, ORIZZONTALE _____ 651
 L-LINE OUT WL _____ 775
 LALU® CONE 15 DIFFUSORE _____ 178
 LALU® ELYPSE 15 DIFFUSORE _____ 178
 LALU® ELYPSE 22 DIFFUSORE _____ 178
 LALU® ELYPSE 33 DIFFUSORE _____ 178
 LALU® PD, E27 _____ 183
 LALU® PD, LED BASE, PHASE _____ 177
 LALU® PD, LED BASE, PHASE, RECESSED _____ 177
 LALU® PLATE 15 DIFFUSORE _____ 178
 LALU® PLATE 22 DIFFUSORE _____ 178
 LALU® SHADE, E27 BASE _____ 183
 LALU® TETRA 14 DIFFUSORE _____ 178
 LALU® TETRA 24 DIFFUSORE _____ 178
 LALU® TETRA 36 DIFFUSORE _____ 178
 LED PANEL 620X620MM _____ 243
 LED SPIKE SP _____ 701
 LED SPOT SP _____ 785
 LID I 45 POLE, SINGLE _____ 611
 LID I 75 POLE, DOUBLE _____ 611
 LID I WL, DOUBLE _____ 713
 LID I WL, SINGLE _____ 713
 LID II WL _____ 711
 LID II WL, UP/DOWN _____ 711
 LIGHT EYE® 150 MONOFASE, PD, QPAR111 _____ 511
 LIGHT EYE® 90 MONOFASE, QPAR51 _____ 511
 LIGHT EYE® 90 PD, GU10 _____ 314
 LIPSY® 30 CW, DOME _____ 423
 LIPSY® 30 CW, DRUM _____ 425
 LIPSY® 40 CW, DOME _____ 423
 LIPSY® 40 CW, DRUM _____ 425
 LIPSY® 40 CW, DRUM, DALI _____ 426
 LIPSY® 50 CW, DOME _____ 423
 LIPSY® 50 CW, DRUM _____ 425
 LIPSY® 50 CW, DRUM, DALI _____ 426
 LISENNE 40 POLE, E27 _____ 662
 LISENNE 70 POLE, E27 _____ 662
 LISENNE PD, E27 _____ 306
 LISENNE WL, E27 _____ 375
 LITTLE SUN TL _____ 443
 LOGS 40 POLE _____ 633
 LOGS 70 POLE _____ 633
 LOGS IN L WL, PHASE _____ 363
 LOGS IN WL _____ 362
 LOGS IN WL, PHASE _____ 362
 LOGS WL _____ 775
 LONG GRILL CW _____ 430
 LYGANT WL, DOUBLE _____ 325
 LYGANT WL, SINGLE _____ 325

M

M-POL 30 POLE _____ 623
 M-POL 60 POLE _____ 623
 M-POL 90 POLE _____ 623
 M-POL M POLEHEAD _____ 619
 M-POL M POLEHEAD, DALI _____ 619
 M-POL M POLEHEAD, LOUVER _____ 621
 M-POL M POLEHEAD, LOUVER, DALI _____ 621
 M-POL M POLEHEAD, SHADER _____ 620
 M-POL M POLEHEAD, SHADER, DALI _____ 620
 M-POL S POLEHEAD _____ 616
 M-POL S POLEHEAD 180°, CON CONTROLLO DELL'ABBAGLIAMENTO _____ 615
 M-POL S POLEHEAD 180°, CON CONTROLLO DELL'ABBAGLIAMENTO, DALI _____ 615
 M-POL S POLEHEAD 360°, CON CONTROLLO DELL'ABBAGLIAMENTO _____ 614
 M-POL S POLEHEAD 360°, CON CONTROLLO DELL'ABBAGLIAMENTO, DALI _____ 614
 M-POL S POLEHEAD, DALI _____ 617
 M-POL S POLEHEAD, LOUVER _____ 618
 M-POL S POLEHEAD, LOUVER, DALI _____ 618

M-POL S POLEHEAD, SHADER _____ 617
 M-POL S POLEHEAD, SHADER, DALI _____ 617
 MAGANDA TL _____ 453
 MAGANDA WL _____ 337
 MANA BASE WL, ROTONDO, PHASE _____ 720
 MANA OUT WL, PHASE _____ 721
 MANA OUT WL, SET _____ 721
 MARONA CL, PHASE _____ 273
 MARYLIN 40/60/90 WL _____ 333
 MEDO® 30 CW, PHASE _____ 161
 MEDO® 30 EL, TELAIO DA INCASSO _____ 171
 MEDO® 30 EL, SENZA TELAIO _____ 170
 MEDO® 40 CW, PHASE _____ 161
 MEDO® 40 EL, TELAIO DA INCASSO _____ 171
 MEDO® 40 EL, SENZA TELAIO _____ 170
 MEDO® 60 CL, QUADRATO, 1-10V _____ 165
 MEDO® 60 CL, QUADRATO, DALI _____ 165
 MEDO® 60 CW, PHASE _____ 161
 MEDO® 60 EL, TELAIO DA INCASSO _____ 171
 MEDO® 60 EL, SENZA TELAIO _____ 170
 MEDO® 90 CL, PHASE _____ 161
 MEDO® PRO 30 CW, DALI _____ 152
 MEDO® PRO 30 CW, DALI, UGR<19 _____ 150
 MEDO® PRO 30 CW, DALI, UGR<19, DC _____ 157
 MEDO® PRO 30 CW, PHASE _____ 152
 MEDO® PRO 30 CW, PHASE, UGR<19 _____ 150
 MEDO® PRO 40 CW, DALI _____ 152
 MEDO® PRO 40 CW, DALI, UGR<19 _____ 150
 MEDO® PRO 40 CW, DALI, UGR<19, DC _____ 157
 MEDO® PRO 40 CW, PHASE _____ 152
 MEDO® PRO 40 CW, PHASE, UGR<19 _____ 150
 MEDO® PRO 60 CW, DALI _____ 153
 MEDO® PRO 60 CW, DALI, UGR<19 _____ 151
 MEDO® PRO 60 CW, DALI, UGR<19, DC _____ 157
 MEDO® PRO 60 CW, PHASE _____ 153
 MEDO® PRO 60 CW, PHASE, UGR<19 _____ 151
 MEDO® PRO 90 CL, DALI _____ 153
 MEDO® PRO 90 CL, DALI, UGR<19 _____ 151
 MEDO® PRO 90 CL, DALI, UGR<19, DC _____ 157
 MEDO® PRO 90 CL, PHASE _____ 153
 MEDO® PRO 90 CL, PHASE, UGR<19 _____ 151
 MEDO® RING 60 PD, 1-10V _____ 167
 MEDO® RING 60 PD, DALI _____ 167
 MEDO® RING 90 PD, 1-10V _____ 167
 MELAN CW, E27 _____ 427
 MERADO FLOOD WL, PHASE _____ 388
 MERIDIAN BOX SENSOR WL, E27 _____ 747
 MERIDIAN BOX WL, E27 _____ 746, 747
 MERIDIAN WL, E27 _____ 746
 MIBO UP/DOWN WL, QT14 _____ 337
 MILANDOS 4 DL _____ 217
 MILANDOS 6 DL _____ 217
 MILANDOS 8 DL _____ 217
 MOBALA EL _____ 243
 MOLAT CL, E27 _____ 799
 MOLAT PD, E27 _____ 661
 MOLAT POLE, E27 _____ 661
 MOLAT WL, E27 _____ 777
 MYRA CW, SINGLE, QPAR51 _____ 785
 MYRA DISPLAY WL, CURVED, QPAR51 _____ 783
 MYRA SPOT DOUBLE, GU10 _____ 685
 MYRA UP/DOWN WL, QPAR51 _____ 764
 MYRA WL, DOUBLE, QPAR51 _____ 811
 NAGY 75 CL, QPAR51 _____ 261

N

NAUTILUS 10 SP, QUADRATO _____ 696
 NAUTILUS 10 SP, ROTONDO, QPAR51 _____ 694, 695
 NAUTILUS 10 SPOT LED SP _____ 697
 NAUTILUS 10 SPOT SP, QPAR51 _____ 697
 NAUTILUS SP, QR-C51 _____ 697
 NAUTILUS WL QPAR51 _____ 785
 NEW TRIA® 150 DL, QUADRATO, QPAR111 _____ 145
 NEW TRIA® 150 DL, ROTONDO, QPAR111 _____ 145
 NEW TRIA® 155 DL, DOUBLE _____ 141
 NEW TRIA® 155 DL, DOUBLE, QPAR51 _____ 145
 NEW TRIA® 300 DL, DOUBLE, QPAR111 _____ 145
 NEW TRIA® 45 DL, ROTONDO _____ 141
 NEW TRIA® 68 DL, QUADRATO, DTW, PHASE _____ 135
 NEW TRIA® 68 DL, QUADRATO, PHASE _____ 134
 NEW TRIA® 68 DL, QUADRATO, QPAR51 _____ 138
 NEW TRIA® 68 DL, ROTONDO, DTW, PHASE _____ 135

NEW TRIA® 68 DL, ROTONDO, PHASE _____ 134, 135
 NEW TRIA® 68 DL, ROTONDO, QPAR51 _____ 138
 NEW TRIA® 75 DL, QUADRATO, QPAR51 _____ 138
 NEW TRIA® 75 DL, ROTONDO, PHASE _____ 137
 NEW TRIA® 75 DL, ROTONDO, QPAR51 _____ 138
 NEW TRIA® 75 XL DL, QUADRATO, QPAR51 _____ 139
 NEW TRIA® 75 XL DL, ROTONDO, QPAR51 _____ 139
 NEW TRIA® UNIVERSAL 68 DL, QUADRATO, PHASE _____ 136,137
 NEW TRIA® UNIVERSAL 68 DL, ROTONDO, PHASE _____ 136,137
 NOBLO® CW, DOUBLE, PHASE _____ 401
 NOBLO® CW, SINGLE, PHASE _____ 401
 NOBLO® CW, TRIPLE, PHASE _____ 401
 NOBLO® SPOT LV, ROPE TRACK _____ 491
 NOBLO® SPOT MONOFASE, PHASE _____ 501, 503
 NOBLO® SPOT MONOFASE, TRIPLE TRACK SET _____ 501
 NOBLO® SPOT TRIFASE, PHASE _____ 545, 547
 NOTAPO L RL _____ 241
 NOTAPO S RL _____ 241
 NOYA PD, PHASE _____ 290
 NUMINOS® 3 PH. _____ 110-113
 NUMINOS® CL _____ 103-105
 NUMINOS® CW _____ 99-101
 NUMINOS® DL _____ 83-85
 NUMINOS® GIMBLE DL _____ 88-89
 NUMINOS® MOVE DL _____ 86-87
 NUMINOS® PD _____ 106-109
 NUMINOS® PROJECTOR DL _____ 91-93
 NUMINOS® S SOSPENSIONE 48V, DALI _____ 471
 NUMINOS® S SPOT 48V, DALI _____ 469
 NUMINOS® XS SOSPENSIONE 48V, DALI _____ 471
 NUMINOS® XS SPOT 48V, DALI _____ 469
 NUMINOS® ZOOM TRACK SYSTEM TRIFASE _____ 115
 NUMINOS® ACCESSORI _____ 94-95

O

OCCLUDAS 13 CL, INDIRECTA, PHASE _____ 262
 OCCLUDAS 23 CL, INDIRECTA, PHASE _____ 262
 OCULUS CL, MOVE, PHASE _____ 229
 OCULUS CL, PHASE _____ 258
 OCULUS CW, PHASE _____ 399
 OCULUS PD, SINGLE, PHASE _____ 294
 OCULUS UP/DOWN WL, PHASE _____ 355
 OCULUS WL, SINGLE, PHASE _____ 355
 ONE® 40 CW, DALI _____ 193
 ONE® 60 CW, DALI _____ 193
 ONE® 60 PD, DALI _____ 188
 ONE® 60 PD, UP/DOWN, DALI _____ 188
 ONE® 60 PD, UP/DOWN, PHASE _____ 188
 ONE® 80 PD, DALI _____ 188
 ONE® 80 PD, UP/DOWN, DALI _____ 188
 ONE® BOW FL, UP/DOWN _____ 197
 ONE® CUBE PD, DALI _____ 189
 ONE® CUBE PD, UP/DOWN, DALI _____ 189
 ONE® DOUBLE PD, UP/DOWN, DALI _____ 189
 ONE® DOUBLE PD, UP/DOWN, PHASE _____ 189
 ONE® LINEAR 100 PD, UP/DOWN, PHASE _____ 191
 ONE® LINEAR 140 PD, UP/DOWN, PHASE _____ 191
 ONE® STRAIGHT FL, UP/DOWN _____ 196
 ONE® TRIPLE PD, DALI _____ 189
 ORDI SENSOR WL _____ 771
 ORDI WL _____ 771
 OSSA 180 WL, QT-DE12 _____ 367
 OSSA 300 WL, QT-DE12 _____ 367
 OTOS GLAS POLE, E27 _____ 659
 OUT-BEAM FRAME SP _____ 811
 OVAL 14 WL, UP/DOWN _____ 715
 OVAL 18 WL, UP/DOWN _____ 715
 OVALISK 100 POLE _____ 653
 OVALISK 75 POLE _____ 653
 OVALISK CL _____ 797
 OVALISK SENSOR WL _____ 757
 OVALISK WL _____ 757

P

PANEL CL, 1200X300MM, DALI _____ 275
 PANEL CL, 1200X300MM, PHASE _____ 275
 PANEL TRACK MONOFASE, QUADRATO _____ 507
 PANEL TRACK MONOFASE, ROTONDO _____ 507

PANTILO 20 PD, E27	281
PANTILO 28 PD, E27	281
PANTILO CONVEX 29 PD, E27	283
PANTILO CONVEX 40 PD, E27	283
PANTILO OVAL PD, E27	281
PANTILO ROPE 19 CW, E27	393
PANTILO ROPE 19 PD, E27	279, 505, 549
PANTILO ROPE 20 PD, E27	279
PANTILO ROPE 27 CW, E27	393
PANTILO ROPE 27 PD, E27	279
PANTILO ROPE WL, G9	345
PARA 380 PD, E27	319
PARA CONE 14 MONOFASE, PD, QPAR51	509
PARA CONE 14 MONOFASE, QPAR51	509
PARA CONE 14 TRIFASE, PD, QPAR51	553
PARA CONE 14 TRIFASE, QPAR51	553
PARA CONE 20 PD, E27	309
PARA CONE 30 PD, E27	309
PARA CONE GL MONOFASE, GU10	508
PARA CONE GL TRIFASE, GU10	552
PARA CONE GL PD, GU10	309, 508, 552
PARA DOME PD, E27	318
PARA DOME DIFFUSORE	318
PEMA® WL	758, 759
PEMA® WL, E27	759
PATTA-I EL, ROTONDO, PHASE	244, 245
PATTA-I EL, SQUADRATO, PHASE	244, 245
PATTA-F EL, ROTONDO, PHASE	246
PATTA-F EL, SQUADRATO, PHASE	247
PHELIA 10 PD, E27	310
PHELIA 20 PD, E27	311
PHELIA 25 PD, E27	311
PHELIA 30 PD, E27	311
PHELIA FL, E27	453
PHELIA WL, QPAR51	388
PHOTONI 45 POLE, E27	605
PHOTONI 75 POLE, E27	605
PHOTONI CL, E27	789
PHOTONI WL, E27	709
PHOTONIA CL, E27	799
PHOTONIA PD, E27	659
PHOTONIA POLE, E27	659
PHOTONIA WL, E27	777
PLASTRA 101 WL, E14	361
PLASTRA 104 CL, E27	271
PLASTRA 104 WL, QT14	361
PLASTRA 105 CL, E27	271
PLASTRA CL, PHASE	271
PLASTRA CL, QPAR51	270
PLASTRA WL, CUBE, QT14	356
PLASTRA WL, CUBES	356
PLASTRA WL, CURVE, QT-DE12	361
PLASTRA WL, E14	357
PLASTRA WL, QPAR51	360
PLYTTA LV	490
POWER TRAIL-LITE® EL, QUADRATO	849
POWER TRAIL-LITE® EL, ROTONDO	849
PURI CW, DOUBLE, QPAR51	411
PURI CW, QUAD, QPAR51	411
PURI CW, SINGLE, QPAR51	411
PURI CW, TRIPLE, QPAR51	411
PURI TRACK MONOFASE, QPAR51	513
PURI TRACK MONOFASE,	
TRIPLE TRACK SET	513
PURI TRACK TRIFASE, QPAR51	557
PURI TRACK GLASS TRIFASE, QPAR51	557
PURIA TRACK MONOFASE, QPAR51	515

Q	
Q-LINE® CL, 1M, BAP, PHASE	253
Q-LINE® CL, 2M, BAP, PHASE	253
Q-LINE® PD, 1M, BAP, PHASE	293
Q-LINE® PD, 2M, BAP, PHASE	293
Q-LINE® PD, DALI, SINGLE	293
Q-LINE® WL	341
QUAD FRAME 14 WL	364
QUAD FRAME 19 WL	364
QUAD FRAME 9 WL	240
QUAD POLE	683
QUAD UP/DOWN 12 WL	753
QUAD UP/DOWN 15 WL	753
QUAD WL	752
QUADRASS PD, E27	307
QUADRASS SPOT WL, E27	375
QUADRASS WL, E27	375

QUADRASYL 75 POLE, TCR-TSE	682
QUADRASYL WL, TCR-TSE	781
QUADRULO CL	811
QUADRULO FL	639
QUADRULO SENSOR WL, E27	745
QUADRULO WL	744
QUADRULO WL, E27	745

R

R-CUBE 35 POLE	609
R-CUBE 75 POLE	609
R-CUBE CW	805
RASCALI 45 POLE	684
RASCALI 65 POLE	684
RASCALI WL	780
ROCCI 200 EL, QUADRATO	855
ROCCI 200 EL, ROTONDO	855
ROCCI EL, QUADRATO	854
ROCCI EL, ROTONDO	854
ROTOBALL 25 FL, E27	657
ROTOBALL 25 PD, E27	317
ROTOBALL 40 FL, E27	657
ROTOBALL 40 PD, E27	317
ROTOBALL 50 FL, E27	657
ROTOBALL 50 PD, E27	317
ROX ACRYL 30 POLE, E27	669
ROX ACRYL 60 POLE, E27	669
ROX ACRYL 90 POLE, E27	669
ROX CL, GX53	801
ROX CL, QPAR111	801
ROX UP/DOWN WL, QPAR111	767
ROX WL, QPAR111	767
RUBA CW	814
RUSTY® 40 POLE	642
RUSTY® 40 POLE, E27	643, 646
RUSTY® 70 POLE	643
RUSTY® 70 POLE, E27	643, 646
RUSTY® CONE 24 FL, E14	645
RUSTY® CONE 40 POLE, E27	645
RUSTY® CONE 70 POLE, E27	645
RUSTY® MANA DIFFUSORE, SQUADRATO	720
RUSTY® MANA DIFFUSORE, ROTONDO	720
RUSTY® PATHLIGHT POLE, TCR-TSE	642
RUSTY® SLOT 50 POLE	640
RUSTY® SLOT 50 POLE, E27	641
RUSTY® SLOT 80 POLE	640
RUSTY® SLOT 80 POLE, E27	641
RUSTY® UP/DOWN WL, QUADRATO	756
RUSTY® UP/DOWN WL, ROTONDO	756

S

S-CUBE 35 POLE	607
S-CUBE 75 POLE	607
S-CUBE CL	791
S-CUBE CW	805
S-TUBE 32 POLE, GU10	603
S-TUBE 75 POLE, GU10	603
S-TUBE CW	805
SALUNA LV, QR-C51	489
SAMRINA SP, SINGLE, GU10	693
SEDO 14 WL	329
SEDO 21 WL	329
SEDO 7 WL	329
SHELL 15 WL, PHASE	365
SHELL 30 WL, PHASE	365
SIGHT 115 CW	431
SIGHT 60 CW	431
SIGHT MOVE TRIFASE	551
SIGHT MOVE TRIFASE, DALI	551
SIGHT TRACK TRIFASE	550
SIGHT TRACK TRIFASE, DALI	550
SITRA 360 CW, TCR-TSE	808
SITRA 360 POLE, TCR-TSE	685
SITRA 360 SPIKE SP, DOUBLE, TCR-TSE	703
SITRA 360 SPIKE SP, SINGLE, TCR-TSE	703
SITRA CL, TCR-TSE	801
SITRA CUBE WL, TCR-TSE	741
SITRA L WL, UP/DOWN, QUADRATO	741
SITRA M WL, UP/DOWN, QUADRATO	741
SITRA S WL, SINGLE, QUADRATO	739
SITRA UP/DOWN WL	765
SITRA UP/DOWN WL, TCR-TSE	765
SITRA WL, TCR-TSE	779
SLOTBOX 40 POLE	678
SLOTBOX 70 POLE	678

SLOTS 45 POLE	675
SLOTS 65 POLE	675
SLOTS WL	768
SMALL PLOT COPERTURA, 3 PZ	851
SMALL PLOT COPERTURA, 2 PZ	851
SMALL PLOT MODULI	851
SOLASTO EL, QUADRATO	857
SOLASTO EL, ROTONDO	857
SOLID CUBE WL, QT14	377
SOPRANA CL, E27	269

SORGENTE LUMINOSA

LED A60 E27	864
LED A60 E27	864
LED A60 E27	864
LED A60 E27, MIRRORHEAD, CHROM	865
LED A60 E27, RGBW, SMART	864
LED A60 E27, TUNABLE 2700-6500K, SMART	864
LED C35 E14	860
LED C35 E14	860
LED G125 E27	865
LED GU10	862
LED GU10	862
LED GU10	862
LED QPAR 111 GU10	863
LED QPAR 111 GU10	863
LED QPAR 111 GU10	863
LED QPAR111 GU10	863
LED QPAR111 GU10	863
LED QPAR111 GU10	864
LED QPAR51 GU10	861
LED QPAR51 GU10	862
LED QPAR51 GU10, RGBW, SMART	861
LED QPAR51 GU10,	
TUNABLE 2700-6500K, SMART	861
LED QR51 GU5.3	861
LED QT14 G9	860
LED QT-DE12 R7S, 118 MM	860
LED QT-DE12 R7S, 78 MM	860
LED ST58 E27	865
LED ST64 E27	865
LED T32 GU10	861
LED T38 E27	865
LED T45 E27	865
LED TCR-TSE GX53	860
QPAR111 GU10, RGBW, SMART	862
QPAR111 GU10, RGBW, SMART	862
QPAR111 GU10,	
TUNABLE 2700-6500K, SMART	863
SPOT 79 CW, QPAR51	409
SPOT DISPLAY E27	389
SQUARE POLE 30 POLE, E27	673
SQUARE POLE 60 POLE, E27	673
SQUARE POLE 90 POLE, E27	673
SQUARE TURN WL, G9	781
SQUARE WL, E27	779
SUN / BIG SUN PD, E27	315
SYNA GARDEN SP	689
SYNA PLANT SP	689
SYNA SP	689
SYROS LV, QR-C51	489

T

TAHA SET DI APPARECCHI,	
BATTERIA	441, 601
TELESKOP LV, QR-C51	486
TENORA CL, E27	268
TENSEO CAVO A BASSO	
VOLTAGGIO	482-484
TENSEO ACCESSORI PER CAVO	
A BASSO VOLTAGGIO	485
TERANG 200 CW	817
THEO BRACKET CW	808
THEO BRACKET SP	701
THEO PATHLIGHT POLE, DOUBLE	652
THEO UP/DOWN WL, QPAR51	377, 735
THEO WL, QPAR51	736
TINY SUN TL	443
TODAY PRO DISPLAY	783
TONGA® MONOFASE, PD, E14	511
TONGA® PD, E14	307
TONILA TL	453, 601

TRAIL-LITE® 60 EL _____	848
TRUKKO 60 WL _____	332
TRUKKO 90 WL _____	332
TRUST 30 POLE _____	667
TRUST 60 POLE _____	667
TS V TRIFASE _____	543

U

UNIVERSAL DOWNLIGHT DL	
WITH COVER, MULTIPACK _____	208, 209
UNIVERSAL DOWNLIGHT DL,	
MOVE, PHASE _____	207
UNIVERSAL DOWNLIGHT DL, PHASE _____	205

V

VANO WING SP, DALI _____	719
VAP SLIM 30 POLE, E27 _____	671
VAP SLIM 60 POLE, E27 _____	671
VAP SLIM 90 POLE, E27 _____	671
VARU EL, QPAR51 _____	234
VARYT CL, E14 _____	251
VARYT TL, E14 _____	443
VARYT WL, E14 _____	327
VILUA L WL _____	763
VILUA S WL _____	763
VILUA UP/DOWN, WL _____	763
VINOLINA ONE TL, BATTERIA	
RICARICABILE _____	437, 597
VINOLINA TL, BATTERIA	
RICARICABILE _____	437, 597
VINOLINA TWO TL, BATTERIA	
RICARICABILE _____	439, 599

W

WALLYX WL, QPAR51 _____	768
WL 106 E14 _____	335
WL 149 WL, PHASE _____	334
WL 149 WL, QT-DE12 _____	334
WORKLIGHT FL _____	445
WORKLIGHT PD, DALI _____	288
WORKLIGHT PRO 120 PD, DALI _____	287
WORKLIGHT PRO 150 PD, DALI _____	287
WORKLIGHT PRO FL, DOUBLE _____	444
WORKLIGHT PRO FL, SINGLE _____	444
WORKLIGHT TL _____	445
WORO EL _____	243

LEGENDA DEI SIMBOLI



Consigli

Visualizza accessori e sorgenti luminose consigliate



Lunghezza cavo di alimentazione in cm
Lunghezza cavo di alimentazione in cm (senza spina)

MIX
match

Mix & Match

Indica prodotti abbinabili



Forma del vano di incasso



Classe di efficienza energetica

Questo apparecchio è adatto a sorgenti luminose con classe di efficienza energetica... (classe)



Indicazione della profondità del vano di incasso

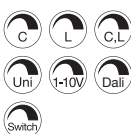

Dimmerabile con:

- **C** = Dimmer a taglio di fase discendente
- **L** = Dimmer a taglio di fase ascendente
- **Uni** = Dimmer universale
- **1-10 V**
- **Dali** = Sistema bus DALI
- **Switch** = Tasto o touch-control sull'apparecchio



Carrabilità del prodotto indicata in tonnellate. I valori si riferiscono ad un apparecchio incassato nel cemento



Capacità di resistenza al carico del prodotto indicato in tonnellate. I valori si riferiscono ad un apparecchio incassato nel cemento



Classe di isolamento

- Classe I / Dispositivi con conduttore di terra
- Classe II / Dispositivi con doppio isolamento
- Classe III / Dispositivi a bassissima tensione SELV



Indica apparecchiature elettriche installabili su materiali il cui grado di infiammabilità non è noto



Possibilità di collegamento multiplo (entra/esci)



Classe di protezione IP

Indica l'idoneità dei materiali elettrici a diverse condizioni ambientali



Alimentatore separato

Driver utilizzabile anche esternamente all'apparecchio



Grado di resistenza agli urti IK

Indica la resistenza degli involucri dei dispositivi elettrici a sollecitazioni meccaniche e soprattutto agli urti.



Trasformatore di sicurezza protetto da cortocircuito



- Utilizzare esclusivamente in ambienti interni
- Non adatto all'uso in ambienti interni



Apertura del fascio luminoso

Indica l'angolo del fascio luminoso in gradi. Più è stretto, più concentrata sarà la luce.



Connected Lighting

Indica prodotti smart che utilizzano i seguenti protocolli:

- Zigbee®
- DALI
- Bluetooth



Orientabilità

- Rotazione
- Inclinazione
- Cardanico



Interruttore CCT

Grazie allo switch CCT è possibile selezionare la temperatura della luce

UGR

Unified Glare Rating

Più basso è il valore UGR, minore sarà l'abbagliamento



Indica apparecchi con luce RGB+W (rosso, verde, blu + bianco) e RGB (rosso, verde, blu)



Mantenimento del flusso luminoso

Indica il tempo di funzionamento durante il quale una sorgente luminosa a LED manterrà la percentuale indicata della sua emissione luminosa iniziale



Dim-to-Warm:

Abbassando la luminosità, la temperatura del colore diventa più calda



Lunghezza del cavo di sospensione in cm



- Prodotti con LED integrato
- Prodotti con attacco per lampadina

Molti dei prodotti presentati in questo catalogo sono protetti da marchi, disegni o modelli, modelli di utilità registrati o brevetti. Una violazione di questi diritti di proprietà oppure l'uso di layout o testi nonché di immagini coperte da copyright senza il nostro consenso saranno perseguiti a norma di legge. Le immagini e indicazioni contenute nel presente catalogo hanno un esclusivo scopo illustrativo e non sono vincolanti per quanto riguarda colore, forma, versione e dati tecnici. Tutte le descrizioni e i dati relativi ai prodotti devono intendersi salvo modifiche ed errori.

Tutti i prodotti del nostro assortimento sono sottoposti a rigorosi controlli qualitativi e soddisfano le comuni norme in vigore. Il catalogo contiene una gamma standard, non adattata a un paese in particolare. Eventuali deviazioni rispetto a specifiche norme nazionali devono essere chiarite prima dell'ordine. SLV non risponde in caso di eventuali norme tecniche divergenti. Tutti i dati relativi a peso e lunghezza sono forniti rispettivamente in kg e cm, salvo ove diversamente specificato. Con riserva di modifiche tecniche.

La presentazione dei nostri apparecchi con foto realistiche ed esemplificative è resa possibile dalla cordiale disponibilità e con l'autorizzazione dei proprietari o dei gestori delle ambientazioni che fanno da sfondo alle foto. Desideriamo ringraziare calorosamente tutti coloro che con il loro consenso hanno contribuito alla realizzazione e all'uso delle nostre foto.

Con la pubblicazione di questo catalogo, i prezzi contenuti nei precedenti listini e cataloghi perdono ogni validità. SLV si riserva il diritto di adeguare i relativi listini prezzi in caso di variazioni delle condizioni di mercato che influiscano sui costi legati agli acquisti, di cambiamenti delle aliquote IVA o dei prezzi di acquisto.

Tutti i prezzi indicati sono prezzi consigliati non vincolanti e sono espressi in euro, IVA esclusa.

Editore
SLV GmbH, Germania
Daimlerstraße 21-23
52531 Übach-Palenberg
T +49 (0) 2451 4833-0
slv.com

Copyright
© SLV GmbH, 2023



SLV GmbH | Daimlerstraße 21-23, 52531 Uebach-Palenberg, Germany, +49 (0) 2451 4833-333, info@slv.de
SLV Austria | +49 (2451) 4833 355, export@slv.de
SLV Belgium | Herentalsebaan 429, B-2160 Wommelgem, +32 (0) 3/385 30 08, info@slv.be
SLV Nordics | Flade Engvej 4, 9900 Frederikshavn, Denmark, +45 9310 7474, info@nordics.slv.com
SLV France | Zac du Martelet, 88, rue Henri Dépaigneux, F-69400 Limas, +33 4 74 02 71 20, infofr@slv.com
SLV LIGHTING UK LTD | Unit E Chiltern Park, Boscombe Road, Dunstable, LU5 5LT, +44 (0)203 968 11 00, sales@uk.slv.com
SLV Italia S.r.l. | Via Lecco, 19/D, 23896 Bevera di Sirtori (LC), +39 039 5983575, infoit@slv.com
SLV Nederland | Kazernestraat 19, 5928 NL Venlo, +31 773204343, info@slv.nl
SLV i Norge, del av SLV Nordics | Tors veg 9B, 7035 Trondheim, +47 4777 1080, post-no@slv.com
SLV Poland | +48 (22) 7224975, slv@slv.pl
SLV Portugal | R. Margarida de Abreu, no13 – Lj2, 1900-314 Lisboa, +351 210 185 961, info@pt.slv.com
SLV Swiss SA | Route du Bey 6 Box 1-4, Z.I. La Jonnaire, CH-1847 Rennaz, +41 218113232, info@slv-swiss.ch
SLV d.o.o | Barjanska cesta 50, SI-1000 Ljubljana, +386 1 2009 730, info@slv.si
SLV Spain | Antic Cami Real Valencia, 38, L17, 08860 Castelldefels, Barcelona, 931 168 161, info@slv.es
SLV Czech s.r.o. | V Sedlci 28/17, CZ-160 00 Praha 6, +420 739 282 151, info@cz.slv.com