

# N 4 ELITE



---

## Elite.

Perchè abbiamo fatto una **scelta**

Decoriamo spazi che vogliono **distinguersi**

Illuminiamo storie che meritano **pregio**

## Elite.

Our **choice**

To adorn rooms so they will **stand out**

To add a sparkle to your **precious** moments

---

# Elite. Lasciati ispirare

Elite.  
Let yourself be inspired



**Novalux** amplia gli orizzonti e presenta una linea di prodotti **decorativi** di **altissima qualità** made in Europe. **Materiali pregiati**

come ottone massiccio, velluti, tessuti e alluminio verniciato in eleganti tinte.

Tutti gli articoli della famiglia Elite sono **retrofit**, per dare la possibilità

all'utente di scegliere e mantenere le sorgenti luminose nella massima semplicità.

**Lasciati ispirare** dalle nuove forme, colori e finiture, entra nel mondo di Elite.



**Novalux** expands its horizons and presents a line of **high quality decorative** products made in Europe. **Precious materials**

such as solid brass, velvets, fabrics and aluminium painted in elegant colours.

All items of the Elite family are **retrofit**, to give the user the opportunity to choose and maintain the light sources with extreme simplicity.

**Be inspired** by new shapes, colors and finishes, enter the world of Elite.





28	CALIMERO
68	CHANEL PT
76	CHANEL TL
32	COLLINS PL
54	COLLINS PR
20	COLLINS SP
24	CRYSTAL
60	CUBRIK
70	DIANA
42	GECO
46	HONEY IN
38	HONEY PL
56	HONEY PR
64	HONEY PT
74	HONEY TL
48	MIND
36	MISS PL
58	MISS PR
50	SPIRIT
66	TINY PT
78	TINY TL

# COLLEZIONI | COLLECTIONS

## COLLINS

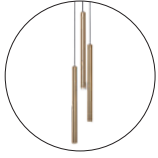

COLLINS SP  
20



COLLINS PL  
32



COLLINS PR  
54

## MISS

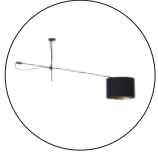

MISS PL  
36



MISS PR  
58

## HONEY



HONEY PL  
38



HONEY IN  
46



HONEY PR  
56



HONEY PT  
64



HONEY TL  
74

## TINY



TINY PT  
66



TINY TL  
78

## CHANEL



CHANEL PT  
68



CHANEL TL  
76

# INSTALLAZIONI | INSTALLATIONS

## SP SOSPENSIONE | SUSPENSION

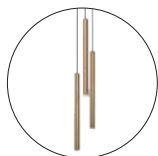

COLLINS SP  
20



CRYSTAL  
24



CALIMERO  
28

## PL PLAFONE | CEILING



COLLINS PL  
32

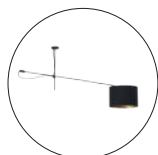

MISS PL  
36



HONEY PL  
38



GECO  
42

## IN INCASSO | RECESSED



HONEY IN  
46



MIND  
48



SPIRIT  
50

## PR PARETE | WALL

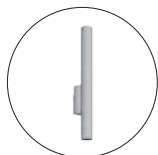

COLLINS PR  
54



MISS PR  
58



HONEY PR  
56

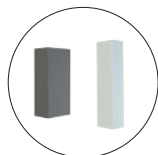

CUBRIK  
60

## PT PIANTANE | FLOOR



HONEY PT  
64



TINY PT  
66



CHANEL PT  
68

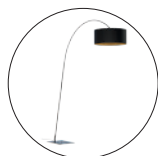

DIANA  
70

## TL TAVOLO | TABLE



HONEY TL  
74



TINY TL  
78



CHANEL TL  
76

# ICONE | SYMBOLS



**IN** Incasso a soffitto in cartongesso  
Recessed into plasterboard ceiling



**PL** Plafone  
Ceiling



**PR** Parete  
Wall



**SP** Sospensione  
Suspended



**PT** Piantana  
Floor lamp



**TL** Lampada da tavolo  
Table lamp



Grado di protezione contro corpi estranei  
di tipo solido e liquido  
Protection class against foreign bodies and water



Alimentato a tensione di rete  
Mains voltage



Prodotto in Europa  
Made in Europe



Garanzia 5 anni  
5 Years warranty

# FINITURE | FINISHES

## METALLO VERNICIATO | PAINTED METAL



**.01** Bianco  
White  
RAL 9003

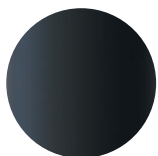

**.02** Nero  
Black  
RAL 9005



**.23** Grigio light  
Light grey  
RAL 7044



**.24** Grigio dark  
Dark grey  
RAL 7022

## OTTONE | SOLID BRASS



**.16** Ottone massiccio  
satinato protetto  
Protected satin  
solid brass

## VELLUTO | VELVET



**.27** Velluto rosa  
Pink velvet



**.28** Velluto blu  
Blue velvet



**.29** Velluto verde  
Green velvet

## TESSUTO | CANVAS



**.25** Tessuto bianco  
White Canvas



**.26** Tessuto nero  
Black canvas

# GUIDA ALLA LETTURA DEL CATALOGO

## HOW TO READ OUR CATALOGUE

**Nome prodotto**  
Product name

**Descrizione**  
Description

**Immagine ambientata**  
Reference image

**Collezione:**  
tutte le tipologie di installazione del prodotto  
Collection:  
all types of product installation

**COMBO COLOR**

**PRODOTTO**  
PISTOLETTA

**CORPO PER SPOT**  
SPOT BODY

**ACCESSORI OPZIONALI**  
OPTIONAL ACCESSORIES

**Materie e finiture**  
Materials and finishes

**Disegni in mm**  
Drawings in mm

**Tabelle codici**  
Codes tables

## CARATTERISTICHE DELLE LAMPADINE

### LIGHT SOURCES FEATURES

Lampadine da acquistare a parte secondo le indicazioni in tabella  
Bulbs to buy separately according to the indications in the table

 1x GU10 LED max 10W Ø51mm H55mm

**Altezza massima**  
Maximum height

**Diametro massimo**  
Maximum diameter

**Potenza massima**  
Maximum power

**Tipologia lampadina**  
Type of bulb

**N° lampadine**  
N° light sources

**Icona lampadina**  
Bulb symbol

# COMBO COLOR

Componi il tuo prodotto: scegli il corpo e gli accessori combinando i colori

Create your product: choose the body and accessories by combining colors

Questa icona indica che il prodotto è da comporre  
This icon means that the product is to be composed

Corpo del prodotto  
Product body

Accessori obbligatori  
Mandatory accessories

Accessori opzionali  
Optional accessories

47

**COMBO COLOR**

**PRODOTTO**  
FIXTURE

**CORPO PER SPOT**  
SPOT BODY

**ACCESSORI OPZIONALI**  
OPTIONAL ACCESSORIES

**BASE**  
.01 .02 Acciaio verniciato texturizzato  
Texturized painted steel

**BASE**  
.01 .02 Texturized painted steel

**SPOT**  
.01 .02 Acciaio verniciato texturizzato  
.16 Ottone massiccio satinato

**SPOT**  
.01 .02 Texturized painted steel  
.16 Satin solid brass

**HONEY IN**

**112404.** \_\_\_ 01 02

1x GU10 LED max 10W Ø51mm H55mm

Euro / pz  
42,75

**ACCESSORI OBBLIGATORI**  
MANDATORY ACCESSORIES

Corpo per spot / Spot body

**112909.** \_\_\_ 01 02

**112909.** \_\_\_ 16

Euro / pz  
11,50  
25,50

**ACCESSORI OPZIONALI**  
OPTIONAL ACCESSORIES

Diffusore decorativo / Decorative diffuser

**112903.99**

Per spot bianco e nero / For white and black spots

Euro / pz  
22,00

**112904.99**

Per spot ottone / For brass spot

Euro / pz  
22,00

**MANS**





# COMPANY PROFILE

# Accendi la luce

## Turn on the light

---

### **Novalux** è un esempio di **imprenditorialità familiare**

emiliana. Una preziosa idea di Gino Persiani, fondatore di Novalux. Classe 1910,

trentenne allo scoppio della Seconda Guerra Mondiale. Proprio in Germania arriva

l'illuminazione: Gino Persiani **vede per la prima volta i tubi**

**fluorescenti** utilizzati dai tedeschi sui sommergibili, e inizia a fantasticare

su come usare quella fonte luminosa che, con un vestito su misura progettato da lui,

diventa un vero apparecchio di illuminazione. Nel 1948 nasce Novalux.

Il **successo dell'azienda** di illuminazione prosegue ancora oggi

con il nipote di Gino, Alessandro Sgrignoli, che ha ereditato l'intuito e il coraggio

imprenditoriale del nonno, conducendo l'impresa con la sua stessa **grinta e**

**lungimiranza.**

Novalux is an example of an Emilian Family entrepreneurship, started by Gino Persiani. He was born in 1910 and at the outbreak of World War II, he was 30 years old. Precisely in Germany he **sees for the first time the fluorescent tubes** on the German submarines and starts dreaming about how to use this lighting source. As a self-designed tailored dress, this innovative source of energy becomes a real lighting device. In 1948 Novalux is established. The work and **SUCCESS of Novalux** continue today with Gino's grandson. Alessandro Sgrignoli inherited his grandfather's intuition and entrepreneurial courage, while leading the company with the same **determination and foresight.**

**Anni di esperienza**

**75**

Years of experience

**Articoli Made in Italy**

**17400**

Made in Italy items

**Codici attivi**

**4755**

Active codes

**Profili venduti in un anno**

**500km**

Profiles sold in a year

**Strip LED vendute in un anno**

**700km**

LED strips sold in a year

**Superficie aziendale**

**30000m<sup>2</sup>**

Company area

**Superficie di produzione**

**12000m<sup>2</sup>**

Production area

**Italian lighting design**  
since 1948

# illuminazione, passo dopo passo

## Lighting, step by step

### 1948

#### Nasce Novalux

Gino Persiani, durante la Seconda Guerra Mondiale, scopre i tubi fluorescenti. Li trasforma in apparecchi di illuminazione e fonda Novalux.

#### Novalux is born

Gino Persiani, during the WWII, discovers the fluorescent tubes. Turns them into lighting fixtures and founds Novalux.

### 1950

#### Primo progetto

Arriva l'illuminazione: Gino Persiani, per farsi conoscere, illumina gratuitamente un negozio sotto i portici di Bologna.

#### First project

Gino Persiani, to make himself known, illuminates for free of charge a shop under the arcades of Bologna.

### 1975

#### Nuova sede

Novalux si trasferisce nella nuova sede industriale a Funo di Argelato (Bologna).

#### New location

Novalux moves to the new industrial headquarters in Funo di Argelato (Bologna).

### 1986

#### Prima fiera

Novalux partecipa alla Fiera Tech Lighting di Milano.

#### First fair

Novalux participates at the Fair Tech Lighting of Milan.

### 2017

#### Espansione

Un business maggiore richiede più spazio: nasce un nuovo magazzino nella sede Novalux.

#### Expansion

A major business requires more space: a new warehouse in headquarters Novalux.

### 2019

#### Acquisizione di SLV

Novalux si integra a SLV Lighting Group Integration. Le sue sedi arrivano all'estero, in Francia, Belgio e Svizzera.

#### Acquisition of SLV

Novalux integrates with SLV Lighting Group Integration. Its headquarters arrive abroad, in France, Belgium and Switzerland.

### 2022

#### Certificazione ISO

Novalux acquisisce la Certificazione del Sistema di gestione integrato per la Qualità e l'Ambiente, secondo le norme UNI EN ISO 9001:2015 e UNI EN ISO 14001:2015

#### ISO certification

Novalux acquires the System certification integrated management for Quality and the Environment, according to the rules UNI EN ISO 9001:2015 and UNI EN ISO 14001:2015

### 2023

#### 75° anniversario

Dal 1948: 75 anni di illuminazione targata Novalux.

#### 75° anniversary

Since 1948: 75 years of lighting Novalux registered.

**Semaforo verde** per la sostenibilità. **Ridurre, Riciclare, Riutilizzare:** Novalux crede fortemente nell'importanza della sostenibilità e nella **salvaguardia del Pianeta**, per un mondo più green.

Green light for sustainability. Reduce, Recycle, Reuse: Novalux strongly believes in the importance of sustainability and in **safeguarding the Planet**, for a greener world.

# Luce sulla sostenibilità

## Light on sustainability

- **PRODOTTI AD ALTA EFFICIENZA ENERGETICA**  
HIGH ENERGY EFFICIENCY PRODUCTS
- **MENO CO<sub>2</sub> GRAZIE ALL'IMPIANTO FOTOVOLTAICO**  
CO<sub>2</sub> SAVINGS THANKS TO PHOTOVOLTAIC SYSTEM
- **CATALOGHI E PACKAGING A MARCHIO FSC®**  
FSC® BRANDED CATALOGUES AND PACKAGING
- **RICICLARE, ANZICHÉ SMALTIRE**  
RECYCLING, RATHER THAN DISPOSING
- **TEAM ECO-FRIENDLY: LA SOSTENIBILITÀ VIENE SCELTA OGNI GIORNO. CI SI SPOSTA IN BICICLETTA O CON AUTO IBRIDE ED ECOLOGICHE, SI UTILIZZANO BORRACCE TERMICHE E STRUMENTI REALIZZATI CON CARTA RICICLATA, SI PREDILIGE IL VETRO ALLA PLASTICA.**  
ECO-FRIENDLY TEAM: SUSTAINABILITY IS CHOSEN EVERY DAY. WE MOVE BY BIKE OR WITH HYBRID AND ECOLOGICAL CARS, THERMAL WATER BOTTLES AND TOOLS MADE WITH RECYCLED PAPER, GLASS IS PREFERRED TO PLASTIC.

**SOSTENIBILITÀ** >  
SUSTAINABILITY



**CERTIFICAZIONI** >  
CERTIFICATIONS



# Sede direzionale

## Headquarter

### NOVALUX ITALY

Via Marzabotto 2  
40050 Funo di Argelato (BO)

tel. +39 051 860558  
fax +39 051 6647859  
info@novalux.it

P.I. 00536541204

Attività dell'azienda gestite  
e coordinate da SLV GmbH

Company activities managed  
and coordinated by SLV GmbH



## Rete vendita estero

### Export sales network

[export@novalux.it](mailto:export@novalux.it)

#### NOVALUX BELGIUM

##### SUBSIDIARY

Herentalsebaan 429  
2160 Wommelgem  
tel. +32 3 385 30 08  
info@novaluxlighting.be

##### STUDIO

Kloosterstraat 18  
2000 Antwerpen  
tel. +32 3 385 30 08

#### NOVALUX FRANCE

##### SUBSIDIARY

Zac du Martelet 88  
Rue Henri Dépaigneux  
F-69400 LIMAS  
tel. +33 4 69 47 00 00  
info@novaluxlighting.fr

#### NOVALUX SWISS

##### SUBSIDIARY

Route du Bey 6 Box 1-4  
Z.I. La Jonnaire  
CH-1847 Rennaz  
tel. +41 21 811 32 32  
info@novaluxlighting.ch

##### STUDIO

Grünaustrasse 18  
8953 Dietikon  
tel. +41 21 811 32 49

#### SPAIN

##### AGENCY Buio Light SL

Calle Héroes Dos de Mayo 3  
29640 Fuengirola, Malaga  
tel. +34 666714024  
light@buio.es

# Rete vendita Italia

## Italy sales network

### VALLE D'AOSTA - PIEMONTE

LIGHT TEAM Snc  
Corso Racconigi, 170  
10141 Torino  
info@agenziait.it  
Cell. Sergio Fichera 335 7206500  
fichera@agenziait.it  
Cell. Niccolò Masinari 349 2141677  
masinari@agenziait.it

### LIGURIA

LAZZARINI MAURO  
Via della Pineta, 58/2  
16011 Arenzano (GE)  
Cell. 347 1532185  
mauro.lazzarini@gmail.com  
www.lazzarinimauro.com

### TOSCANA

CHELINI ILLUMINOTECNICA  
di Chelini Filippo  
Via Vittorio Emanuele, 33  
50041 Calenzano (FI)  
Tel. 055 8811208  
Cell. Filippo Chelini 335 6109402  
Cell. Daniele Cammelli 335 6118944  
Cell. Paolo Nuzzolese 338 6250103  
info@cheliniilluminotecnica.it

### SARDEGNA

Costa Danilo  
Via Torres 7/C  
07100 Sassari  
Tel./Fax 079 4922990  
Cell. Danilo Costa 335 6079614  
costadanilo.dc@gmail.com

### SICILIA

SVR S.r.l.  
Viale Resurrezione, 19  
90146 Palermo  
Tel. 091 6791971  
Fax 091 6791960  
Cell. Vincenzo Salerno 335 5762757  
info@svrsalerno.it  
Progettazione illuminotecnica  
Rosario Muliedda  
Cell. 335 1331776  
muliedda@svrsalerno.it

### LOMBARDIA

CERVO RAPPRESENTANZE  
di De Pascalis Riccardo & C SaS  
Via Papa Giovanni II, 20  
24058 Fara Olivana con Sola (BG)  
ag.cervo.commerciale@gmail.com  
commerciale@cervorap.com  
(Bergamo, Brescia, Cremona, Mantova,  
Monza-Brianza, Milano provincia, Lodi, Sondrio)  
Cell. Riccardo De Pascalis 340 4076095  
Cell. Carlo Cattaneo 347 4618150  
(Como, Lecco, Varese, Milano città, Pavia)  
Cell. Rinaldo Roberti 335 458140  
Progettazione illuminotecnica  
Mariangela Giacomazzi  
Cell. 333 3394396  
mg68.design@gmail.com

### MARCHE - UMBRIA

DLR Srl  
Via Colle Pineta, 23  
65129 Pescara  
Tel./Fax 085 4516270  
Cell. Roberto Di Leonardo 337 913221  
Cell. Gabriele Luzi 334 9100399  
info@dldrappresentanze.it

### LAZIO

3EL Snc. Rappresentanze  
Uffici e showroom:  
via Ubaldo Montelatici, 26  
00134 Roma  
Tel. 06 71356133  
Cell. Fabio Buonadonna 335 6408457  
Cell. Roberto La Rosa 335 6408263  
Cell. Andrea Lupi 335 6408448  
info@3elrappresentanze.it  
www.3elrappresentanze.it  
Progettazione illuminotecnica  
STUDIOLUCE3  
Fabio Buonadonna  
Cell. 335 6408457  
progettazione@3elrappresentanze.it

### CAMPANIA

Punzo Salvatore  
Via Napoli, 159 C.C. Meridiana  
80013 Casalnuovo di Napoli (NA)  
Tel. 081 5228441  
Cell. Punzo Salvatore 337 971401  
Cell. Roberto Cirillo 334 6289262  
Cell. Esposito Davide 335 1370844  
info@luminattech.it

### CALABRIA

Lu Ce & C Srl  
Via S.S. Pietro e Paolo, 16  
87040 Cerzeto (CS)  
Cell. Luciano Celestino 393 4142443  
lu.ce.srl@gmail.com

### VENETO TRENTINO ALTO ADIGE FRIULI VENEZIA GIULIA

(Padova, Vicenza, Rovigo, Venezia)  
SITEL Srl (sede)  
Via Lisbona, 28/A  
35127 Padova  
Tel. 049 760999  
info@sitelx.it

(Verona, Trentino Alto Adige)  
SITEL Srl (filiale)  
Via Spagnole, 2/B  
37015 Sant' Ambrogio di Valpolicella (VR)  
Tel. 049 760999  
info@sitelx.it

(Treviso, Belluno, Friuli Venezia Giulia)  
SITEL Srl (filiale)  
Via Don Pietro della Toffola, 24  
33074 Fontanafredda (PN)  
Tel. 049 760999  
info@sitelx.it

### EMILIA ROMAGNA

B & Q ILLUMINOTECNICA Srl  
Centergross Blocco 2A n° 147  
40050 Funo di Argelato (BO)  
Tel. 051 861445  
Cell. Adriano Querciagrossa 348 7813992  
Cell. Lorenzo Pierini 348 7813993  
Cell. Daniele Molinari 348 0306938  
Cell. Mattia Grazi 388 4479463  
Cell. Andrea Bettuzzi 351 7584637  
info@bqsr.it  
www.bqsr.it

### ABRUZZO - MOLISE

DLR Srl  
Via Colle Pineta, 23  
65129 Pescara  
Tel./Fax 085 4516270  
Cell. Roberto Di Leonardo 337 913221  
info@dldrappresentanze.it

### PUGLIA - BASILICATA

VERDEBELLO RAPPRESENTANZE Sas  
Via Don Guanella, 15/g  
70124 Bari  
Tel. 080 5023511 - 080 5024922  
Cell. Daniele Verdebello  
346 1007163  
info@verdebello.it  
d.verdebello@verdebello.it

(Bari, Barletta-Andria-Trani, Foggia e Basilicata)  
Cell. Dario De Francesco 347 1892574  
d.defrancesco@verdebello.it

(Lecce, Brindisi, Taranto)  
Cell. Cristian Campeggio 380 1013239  
c.campeggio@verdebello.it





**SOSPENSIONE**  
SUSPENSION

# COLLINS SP

Cilindri per installazione a sospensione, in acciaio verniciato texturizzato oppure in ottone massiccio satinato. Differenti diametri e lunghezze, combinabili con rosoni singoli, a tre elementi in linea o a grappolo.

Cylinders for suspension installation, in texturized painted steel or satin solid brass. Different diameters and lengths are available, and they can be combined with single, 3x linear or 3x round canopies.



## COLLEZIONE COLLINS | COLLINS COLLECTION



COLLINS SP  
Pg 20



COLLINS PL  
Pg 32



COLLINS PR  
Pg 54



# COMPONI IL TUO COLLINS

## CREATE YOUR COLLINS

**COMBO COLOR: Scegli il corpo e gli accessori combinando i colori**  
**COMBO COLOR: Choose the body and accessories by combining colors**

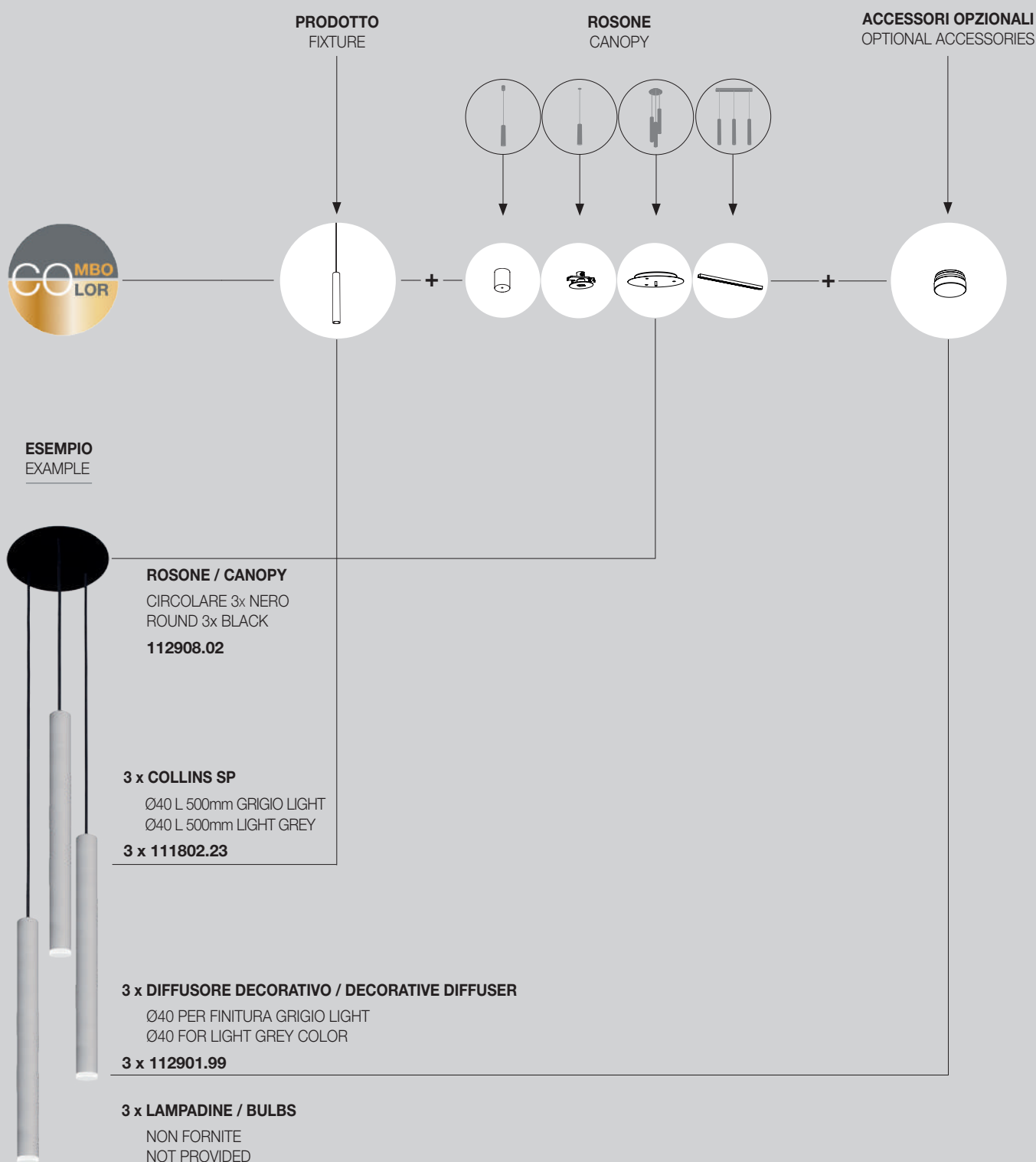



CAVO  
lunghezza regolabile  
.01 Guaina bianca  
.02 .23 .24 .16 Guaina nera

CABLE  
adjustable length  
.01 White sheath  
.02 .23 .24 .16 Black sheath



.01 .02 .23 .24 Acciaio verniciato texturizzato  
.16 Ottone massiccio satinato  
.01 .02 .23 .24 Texturized painted steel  
.16 Satin solid brass

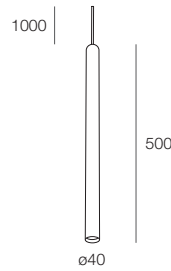
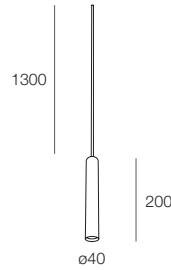

COLLINS SP Ø40

L 200mm

					Euro / pz
<b>111801.</b> __	<b>01</b>	<b>02</b>	<b>23</b>	<b>24</b>	51,25

		Euro / pz
<b>111801.</b> __	<b>16</b>	65,00

1x GU10 MINI LED max 10W Ø35mm H46mm

L 500mm

					Euro / pz
<b>111802.</b> __	<b>01</b>	<b>02</b>	<b>23</b>	<b>24</b>	65,00

		Euro / pz
<b>111802.</b> __	<b>16</b>	111,75

1x GU10 MINI LED max 10W Ø35mm H46mm

COLLINS SP Ø55

L 200mm

					Euro / pz
<b>111803.</b> __	<b>01</b>	<b>02</b>	<b>23</b>	<b>24</b>	56,00

		Euro / pz
<b>111803.</b> __	<b>16</b>	72,50

1x GU10 LED max 10W Ø51mm H55mm

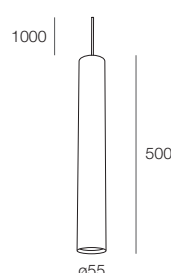
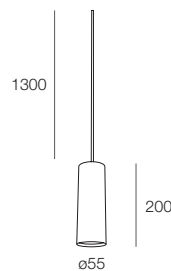

L 500mm

					Euro / pz
<b>111804.</b> __	<b>01</b>	<b>02</b>	<b>23</b>	<b>24</b>	69,00

		Euro / pz
<b>111804.</b> __	<b>16</b>	136,50

1x GU10 LED max 10W Ø51mm H55mm

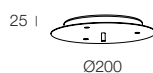
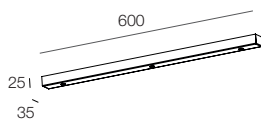
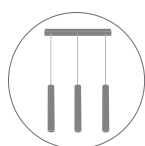
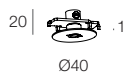
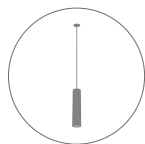
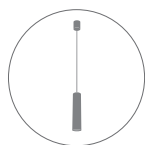

## ACCESSORI OBBLIGATORI MANDATORY ACCESSORIES

Rosoni / Canopies

1x plafone / 1x ceiling

Euro / pz  
**112905. \_\_ 01 02 23 24** 18,50

Da combinare con 1 Collins SP / To combine with 1 Collins SP

1x incasso / 1x recessed

Euro / pz  
**112906. \_\_ 01 02 23 24** 12,25

Da combinare con 1 Collins SP / To combine with 1 Collins SP

3x lineare / 3x linear

Euro / pz  
**112907. \_\_ 01 02 23 24** 28,25

Da combinare con 3 Collins SP / To combine with 3 Collins SP

3x circolare / 3x round

Euro / pz  
**112908. \_\_ 01 02 23 24** 38,00

Da combinare con 3 Collins SP / To combine with 3 Collins SP

ROSONI  
.01 .02 .23 .24 Acciaio verniciato

CANOPIES  
.01 .02 .23 .24 Painted steel



Ø 40mm

Euro / pz  
**112901.99** 17,25

Per bianco, nero, grigio dark e grigio light / For white, black, dark grey and light grey

Euro / pz  
**112902.99** 17,25

Per ottone / For brass



Ø 55mm

Euro / pz  
**112903.99** 22,00

Per bianco, nero, grigio dark e grigio light / For white, black, dark grey and light grey

Euro / pz  
**112904.99** 22,00

Per ottone / For brass

# CRYSTAL

Cilindri per installazione a sospensione, con vetro extra chiaro trasparente esterno, e acciaio verniciato texturizzato oppure ottone massiccio satinato all'interno. Combinabili con rosoni singoli, a tre elementi in linea o a grappolo.

Cylinders for pendant installation, with extra clear transparent glass outside, and painted texturized steel or satin solid brass inside. They can be combined with single, 3x linear or 3x round canopies.



# COMPONI IL TUO CRYSTAL

## CREATE YOUR CRYSTAL

**COMBO COLOR: Scegli il corpo e gli accessori combinando i colori**  
**COMBO COLOR: Choose the body and accessories by combining colors**

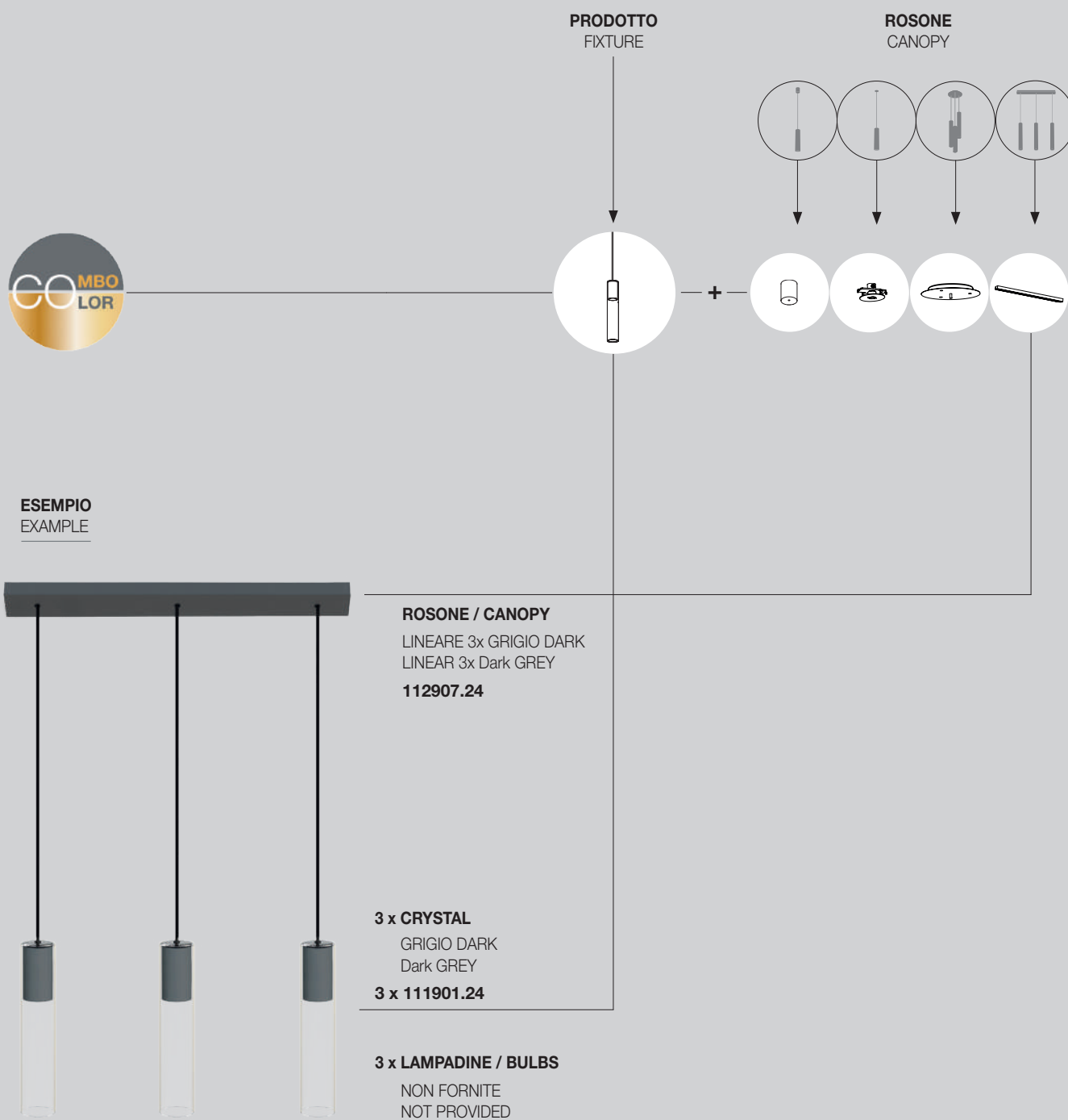





CAVO  
lunghezza regolabile  
.23 .24 .16 Guaina nera

CABLE  
adjustable length  
.23 .24 .16 Black sheath

.23 .24 Interno in acciaio verniciato texturizzato,  
esterno in vetro extrachiaro trasparente  
.16 Interno in ottone massiccio satinato,  
esterno in vetro extrachiaro trasparente

.23 .24 Inside texturized painted steel, outside  
extra clear transparent glass  
.16 Inside satin solid brass,  
outside extra clear transparent glass

ROSONI  
.01 .02 .23 .24 Acciaio verniciato

CANOPIES  
.01 .02 .23 .24 Painted steel





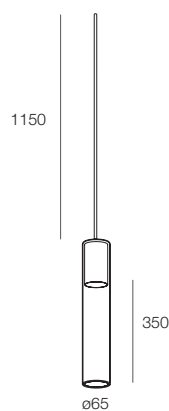

## CRYSTAL

	<input type="checkbox"/>	<input type="checkbox"/>	Euro / pz
<b>111901.</b>	<b>23</b>	<b>24</b>	69,75

	<input type="checkbox"/>		Euro / pz
<b>111901.</b>	<b>16</b>		81,75

1x GU10 LED max 10W Ø51mm H55mm

### ACCESSORI OBBLIGATORI

### MANDATORY ACCESSORIES

## Rosoni / Canopies

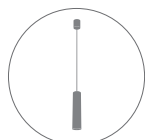

1x plafone / 1x ceiling

	<input type="checkbox"/>	<input type="checkbox"/>	<input type="checkbox"/>	<input type="checkbox"/>	Euro / pz
<b>112905.</b>	<b>01</b>	<b>02</b>	<b>23</b>	<b>24</b>	18,50

Da combinare con 1 Crystal / To combine with 1 Crystal

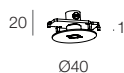
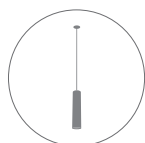

1x incasso / 1x recessed

	<input type="checkbox"/>	<input type="checkbox"/>	<input type="checkbox"/>	<input type="checkbox"/>	Euro / pz
<b>112906.</b>	<b>01</b>	<b>02</b>	<b>23</b>	<b>24</b>	12,25

Da combinare con 1 Crystal / To combine with 1 Crystal

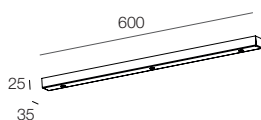

3x lineare / 3x linear

	<input type="checkbox"/>	<input type="checkbox"/>	<input type="checkbox"/>	<input type="checkbox"/>	Euro / pz
<b>112907.</b>	<b>01</b>	<b>02</b>	<b>23</b>	<b>24</b>	28,25

Da combinare con 3 Crystal / To combine with 3 Crystal

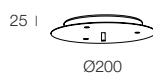

3x circolare / 3x round

	<input type="checkbox"/>	<input type="checkbox"/>	<input type="checkbox"/>	<input type="checkbox"/>	Euro / pz
<b>112908.</b>	<b>01</b>	<b>02</b>	<b>23</b>	<b>24</b>	38,00

Da combinare con 3 Crystal / To combine with 3 Crystal

# CALIMERO

Sospensioni a luce diretta in materiale composito verniciato grigio chiaro o grigio scuro, con schermo diffondente arretrato. Sospensioni in Kevlar e cavo di alimentazione con protezione in treccia nera.

Direct light suspensions in light grey or dark grey composite material, with backward diffuser screen. Suspension cables made of black Kevlar and black braided power cable.



ROSONE  
**.23** Acciaio verniciato,  
 grigio light  
**.24** Acciaio verniciato,  
 grigio dark

CANOPIE  
**.23** Painted steel,  
 light grey  
**.24** Painted steel,  
 dark grey

CAVI  
 Sospensioni in Kevlar neri,  
 Cavo alimentazione con protezione in  
 treccia nera. Lunghezza regolabile

CABLES  
 Black Kevlar suspensions  
 Black braided power cable  
 Adjustable length

MAINS

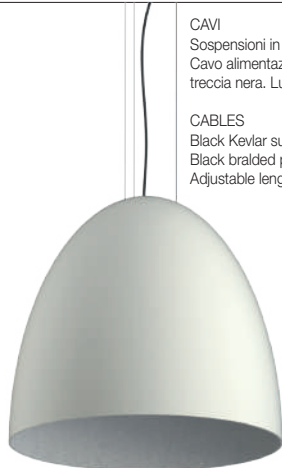

PARALUME  
**.23** Composito grigio light, interno grigio light  
**.24** Composito grigio dark, interno grigio light

SHADE  
**.23** Light grey composite, inside light grey  
**.24** Dark grey composite, inside light grey

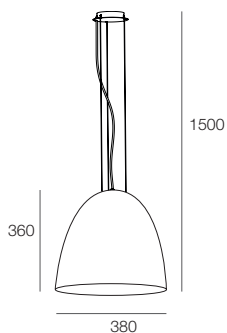

## CALIMERO M



Euro / pz

**111702. \_\_ 23 24**

379,00

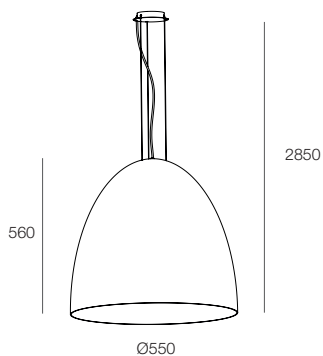
 1x E27 LED max 25W

## CALIMERO L



Euro / pz

**111703. \_\_ 23 24**

692,50

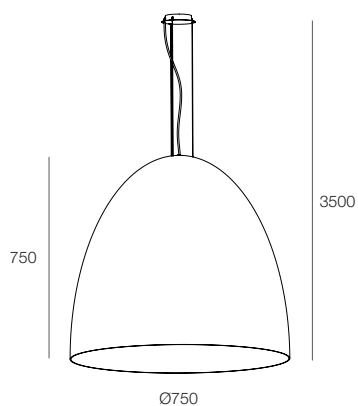
 5x E27 LED max 25W Ø60mm H110mm

## CALIMERO XL



Euro / pz

**111701. \_\_ 23 24**

1026,00

 7x E27 LED max 25W Ø60mm H110mm



**PLAFONE**  
CEILING



# COLLINS PL

Cilindri per installazione a plafone, in acciaio verniciato texturizzato bianco, nero, grigio chiaro o grigio scuro, oppure in ottone massiccio satinato. Diametri 40 e 55mm, lunghezze 200, 500 e 1000mm.

Cylinders for surface-mounted installation, in white, black, light grey or dark grey painted steel, or in satin solid brass. Diameters 40 and 55mm and lengths 200, 500 and 1000mm.



## COLLEZIONE COLLINS | COLLINS COLLECTION



COLLINS SP  
Pg 20



COLLINS PL  
Pg 32



COLLINS PR  
Pg 54



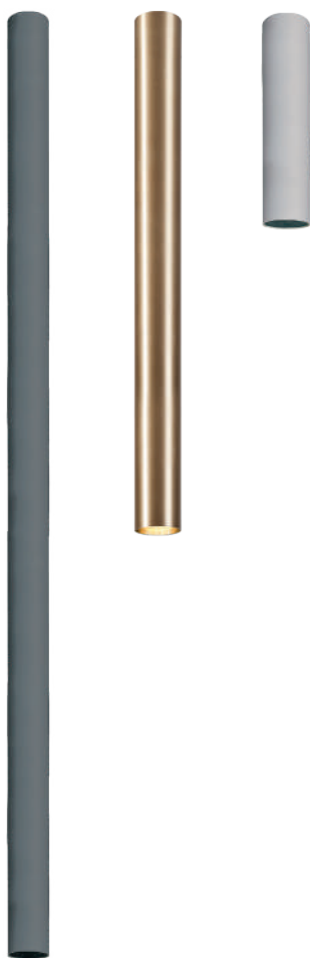

.01 .02 .23 .24 Acciaio verniciato texturizzato  
.16 Ottone massiccio satinato

.01 .02 .23 .24 Texturized painted steel  
.16 Satin solid brass

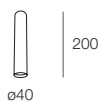

### COLLINS PL Ø40

L 200mm



Euro / pz

**111805. \_\_ 01 02 23 24**

29,50



**111805. \_\_ 16**

45,50

1x GU10 MINI LED max 10W Ø35mm H46mm



L 500mm



Euro / pz

**111806. \_\_ 01 02 23 24**

45,50



**111806. \_\_ 16**

96,75

1x GU10 MINI LED max 10W Ø35mm H46mm

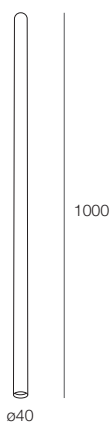

L 1000mm



Euro / pz

**111807. \_\_ 01 02 23 24**

83,50



**111807. \_\_ 16**

187,00

1x GU10 MINI LED max 10W Ø35mm H46mm

## COLLINS PL



.01 .02 .23 .24 Acciaio verniciato texturizzato  
 .16 Ottone massiccio satinato

.01 .02 .23 .24 Texturized painted steel  
 .16 Satin solid brass

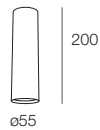

## COLLINS PL Ø55

L 200mm

	<input type="checkbox"/>	<input type="checkbox"/>	<input type="checkbox"/>	<input type="checkbox"/>	Euro / pz
<b>111808.</b> __	<b>01</b>	<b>02</b>	<b>23</b>	<b>24</b>	39,25

	<input type="checkbox"/>				Euro / pz
<b>111808.</b> __	<b>16</b>				71,50

1x GU10 LED max 10W Ø51mm H55mm

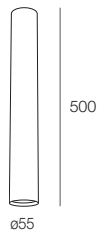

L 500mm

	<input type="checkbox"/>	<input type="checkbox"/>	<input type="checkbox"/>	<input type="checkbox"/>	Euro / pz
<b>111809.</b> __	<b>01</b>	<b>02</b>	<b>23</b>	<b>24</b>	60,00

	<input type="checkbox"/>				Euro / pz
<b>111809.</b> __	<b>16</b>				125,50

1x GU10 LED max 10W Ø51mm H55mm

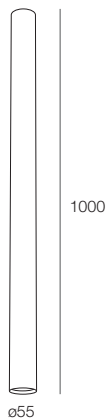

L 1000mm

	<input type="checkbox"/>	<input type="checkbox"/>	<input type="checkbox"/>	<input type="checkbox"/>	Euro / pz
<b>111810.</b> __	<b>01</b>	<b>02</b>	<b>23</b>	<b>24</b>	94,50

	<input type="checkbox"/>				Euro / pz
<b>111810.</b> __	<b>16</b>				237,00

1x GU10 LED max 10W Ø51mm H55mm





Ø40

110

**ACCESSORI OPZIONALI**

## OPTIONAL ACCESSORIES

Diffusore decorativo / Decorative diffuser

Ø 40mm



Euro / pz

**112901.99**

17,25

Per bianco, nero, grigio dark e grigio light / For white, black, dark grey and light grey



Euro / pz

**112902.99**

17,25

Per ottone / For brass



Ø55

110

Ø 55mm



Euro / pz

**112903.99**

22,00

Per bianco, nero, grigio dark e grigio light / For white, black, dark grey and light grey



Euro / pz

**112904.99**

22,00

Per ottone / For brass

# MISS PL

Apparecchio per installazione a plafone composto da asta verticale e braccio snodato regolabile con portalampana, combinabile con paralume in velluto o in tessuto, in diverse finiture.

Surface mounted fixture composed of vertical rod and adjustable articulated arm with lamp holder, combinabile with velvet or fabric lampshade, available in different finishes.



## COLLEZIONE MISS | MISS COLLECTION



MISS PL  
Pg 36

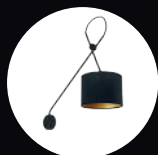

MISS PR  
Pg 58





PRODOTTO  
FIXTURE



PARALUME  
SHADE

MAINS

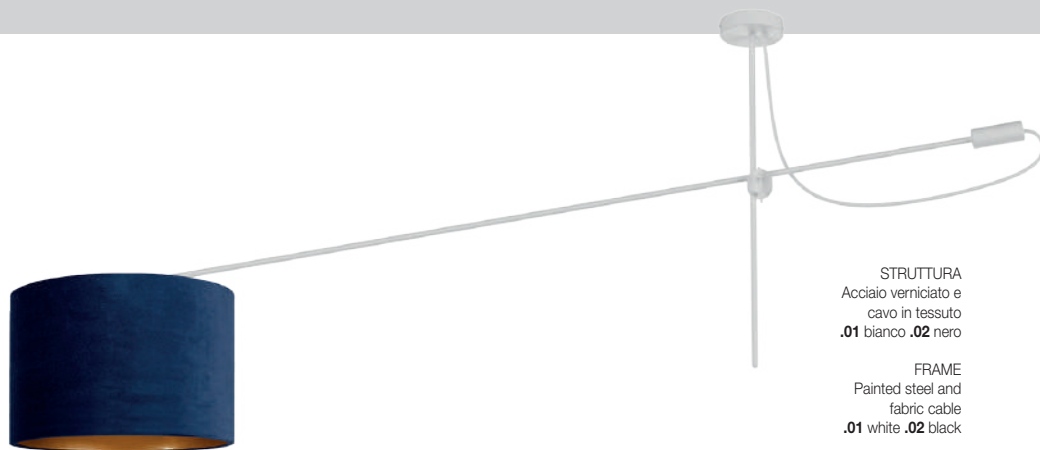

STRUTTURA  
Acciaio verniciato e  
cavo in tessuto  
**.01** bianco **.02** nero

FRAME  
Painted steel and  
fabric cable  
**.01** white **.02** black

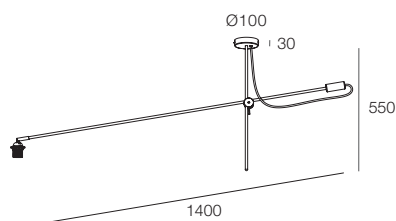

### MISS PL

	<input type="checkbox"/>	<input type="checkbox"/>	Euro / pz
<b>111601.</b> __	<b>01</b>	<b>02</b>	134,75

1x E27 LED max 25W

### ACCESSORI OBBLIGATORI MANDATORY ACCESSORIES

#### Paralume / Shade

	<input type="checkbox"/>	<input type="checkbox"/>	Euro / pz	
<b>112911.</b> __	<b>25</b>	<b>26</b>	97,25	
<b>112911.</b> __	<b>27</b>	<b>28</b>	<b>29</b>	145,00

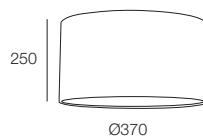

PARALUME  
**.25** Tessuto bianco, interno bianco  
SHADE  
**.25** White canvas, inside white



PARALUME  
**.26** Tessuto nero, interno oro  
SHADE  
**.26** Black canvas, inside gold



PARALUME  
**.27** Velluto rosa, interno bianco  
SHADE  
**.27** Pink velvet, inside white



PARALUME  
**.28** Velluto blu, interno oro  
SHADE  
**.28** Blue velvet, inside gold



PARALUME  
**.29** Velluto verde, interno oro  
SHADE  
**.29** Green velvet, inside gold

# HONEY PL

Prodotto per installazione a plafone composto da spot orientabili combinabili con base circolare per spot singolo, oppure con profili lineari per spot multipli. Corpo in acciaio verniciato oppure in ottone massiccio satinato.

Surface mounted installation fixture composed of adjustable spots that can be combined with a circular base for single spot, or with linear profiles for multiple spots. Body in painted steel or satin solid brass.



## COLLEZIONE HONEY | HONEY COLLECTION



HONEY PL  
Pg 38



HONEY IN  
Pg 46



HONEY PR  
Pg 56

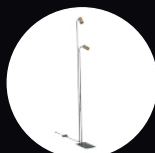

HONEY PT  
Pg 64

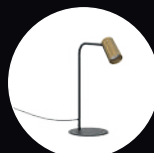

HONEY TL  
Pg 74



# COMPONI IL TUO HONEY PL

## CREATE YOUR HONEY PL

**COMBO COLOR: Scegli il corpo e gli accessori combinando i colori**  
**COMBO COLOR: Choose the body and accessories by combining colors**

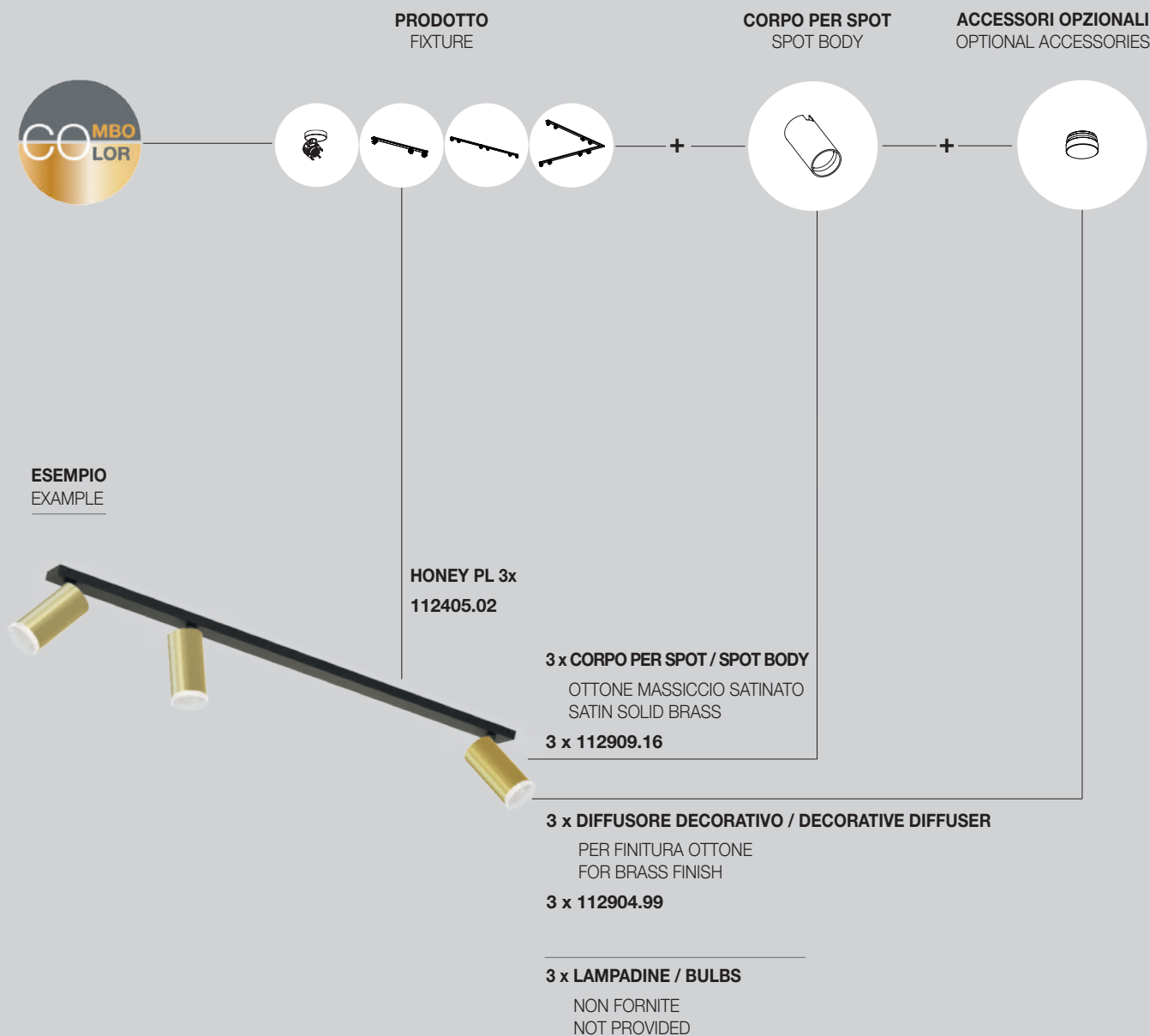

## HONEY PL

MAINS



BASE  
**.01 .02** Acciaio verniciato texturizzato

BASE  
**.01 .02** Texturized painted steel

SPOT  
**.01 .02** Acciaio verniciato texturizzato  
**.16** Ottone massiccio satinato

SPOT  
**.01 .02** Texturized painted steel  
**.16** Satin solid brass

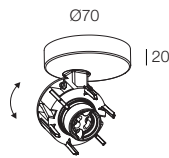

## HONEY PL 1x



Euro / pz

**112403. \_\_ 01 02**

40,25

Da combinare con 1 corpo per spot / To combine with 1 spot body

1x GU10 LED max 10W Ø51mm H55mm

## HONEY PL 3x



Euro / pz

**112405. \_\_ 01 02**

101,25

Da combinare con 3 corpi per spot / To combine with 3 spot bodies

3x GU10 LED max 10W Ø51mm H55mm

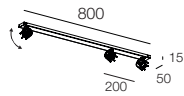

## HONEY PL 6x



Euro / pz

**112406. \_\_ 01 02**

215,25

Da combinare con 6 corpi per spot / To combine with 6 spot bodies

6x GU10 LED max 10W Ø51mm H55mm

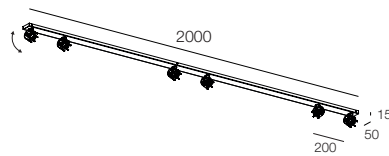

## HONEY PL 8x ANGOLARE / 8x CORNER



Euro / pz

**112407. \_\_ 01 02**

356,50

Da combinare con 8 corpi per spot / To combine with 8 spot bodies

8x GU10 LED max 10W Ø51mm H55mm

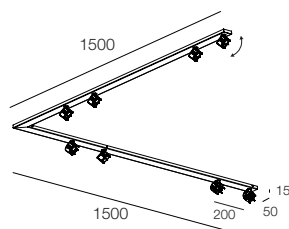

## ACCESSORI OBBLIGATORI MANDATORY ACCESSORIES

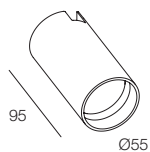

Corpo per spot / Spot body

		Euro / pz
112909. __	01 02	11,50
112909. __	16	25,50

## ACCESSORI OPZIONALI OPTIONAL ACCESSORIES

Diffusore decorativo / Decorative diffuser



	Euro / pz
112903.99	22,00

Per spot bianco e nero / For white and black spots

	Euro / pz
112904.99	22,00

Per spot ottone / For brass spot



SPOT  
.01 .02 Acciaio verniciato texturizzato  
.16 Ottone massiccio satinato

SPOT  
.01 .02 Texturized painted steel  
.16 Satin solid brass

BASE  
.01 .02 Acciaio verniciato texturizzato

BASE  
.01 .02 Texturized painted steel



# GECO

Apparecchio IP54 per installazione a plafone, di forma tonda o quadrata. Corpo in alluminio verniciato bianco o nero e schermo in vetro trasparente.

IP54 fixture for surface mounted installation, round or square shape. Body made of white or black painted aluminium and transparent glass screen.





MAINS

IP  
54.01 .02 Alluminio verniciato,  
Schermo in vetro.01 .02 Painted aluminium,  
Glass screen

## GECO TONDO / GECO ROUND



Euro / pz

**112001. \_\_ 01 02**

60,50

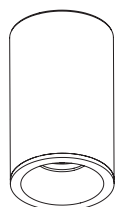
 1x GU10 LED max 10W Ø51mm H55mm

135

Ø85

MAINS

IP  
54.01 .02 Alluminio verniciato,  
Schermo in vetro.01 .02 Painted aluminium,  
Glass screen

## GECO QUADRATO / GECO SQUARE



Euro / pz

**112002. \_\_ 01 02**

74,75

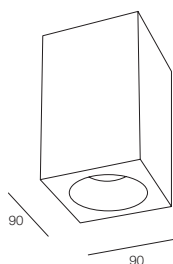
 1x GU10 LED max 10W Ø51mm H55mm

135

90

90



**INCASSO**  
RECESSED

# HONEY IN

Spot orientabile in acciaio verniciato texturizzato bianco o nero oppure in ottone massiccio satinato, combinabile con basetta circolare con portalamпада da incasso su controsoffitto in cartongesso.

Adjustable spot made of white or black painted steel or satin solid brass, combinabile with circular base with recessed lamp holder for plasterboard ceiling mounting.



## COLLEZIONE HONEY | HONEY COLLECTION



HONEY PL  
Pg 38



HONEY IN  
Pg 46



HONEY PR  
Pg 56

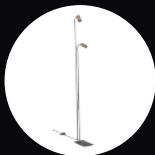

HONEY PT  
Pg 64

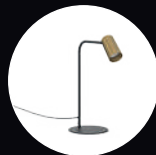

HONEY TL  
Pg 74





**PRODOTTO**  
FIXTURE



**CORPO PER SPOT**  
SPOT BODY



**ACCESSORI OPZIONALI**  
OPTIONAL ACCESSORIES



BASE  
.01 .02 Acciaio verniciato  
texturizzato

BASE  
.01 .02 Texturized painted  
steel

SPOT  
.01 .02 Acciaio verniciato texturizzato  
.16 Ottone massiccio satinato

SPOT  
.01 .02 Texturized painted steel  
.16 Satin solid brass

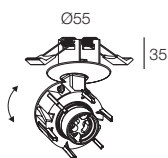

## HONEY IN

112404. \_\_ 01 02

Euro / pz

42,75

1x GU10 LED max 10W Ø51mm H55mm



## ACCESSORI OBBLIGATORI

  
MANDATORY ACCESSORIES

Corpo per spot / Spot body

112909. \_\_ 01 02

Euro / pz

11,50

112909. \_\_ 16

25,50

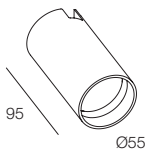

## ACCESSORI OPZIONALI

  
OPTIONAL ACCESSORIES

Diffusore decorativo / Decorative diffuser

112903.99

Euro / pz

22,00

Per spot bianco e nero / For white and black spots

112904.99

Euro / pz

22,00

Per spot ottone / For brass spot





# MIND

Faretto IP54 tondo o quadrato per installazione ad incasso su controsoffitto in cartongesso o pannelli con struttura a vista. Con cornice in battuta in alluminio verniciato bianco o nero e vetro trasparente.

Round or square IP54 downlight for recessed installation on plasterboard or exposed grid ceiling. Made of white or black painted aluminium frame and transparent glass.

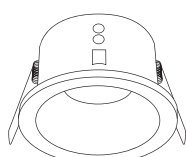
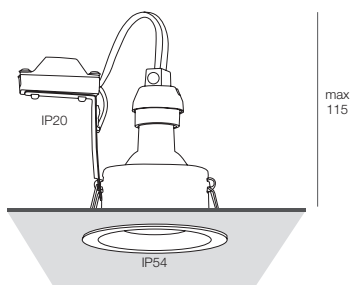

MAINS

IP  
54.01 .02 Alluminio verniciato,  
Schermo in vetro.01 .02 Painted aluminium,  
Glass screen

Ø85



## MIND TONDO / MIND ROUND

   
**112101. \_\_ 01 02**
Euro / pz  
24,25

1x GU10 LED max 10W Ø51mm H55mm

MAINS

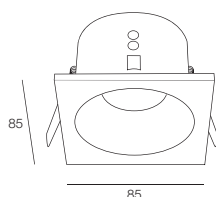
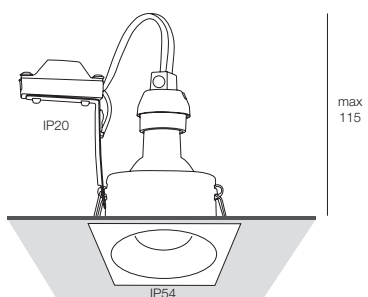
IP  
54.01 .02 Alluminio verniciato,  
Schermo in vetro.01 .02 Painted aluminium,  
Glass screen

85



## MIND QUADRATO / MIND SQUARE

   
**112102. \_\_ 01 02**
Euro / pz  
26,00

1x GU10 LED max 10W Ø51mm H55mm

# SPIRIT



Faretto IP54 tondo per installazione ad incasso su controsoffitto in cartongesso o pannelli con struttura a vista. Con cornice in battuta o con flangia per incasso a rasamento, in alluminio verniciato bianco o nero e vetro trasparente.

IP54 round spotlight for recessed installation on plasterboard or exposed grid ceiling. Frame or frameless version for plasterboard ceiling, in white or black painted aluminium and transparent glass.



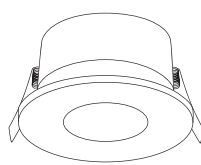
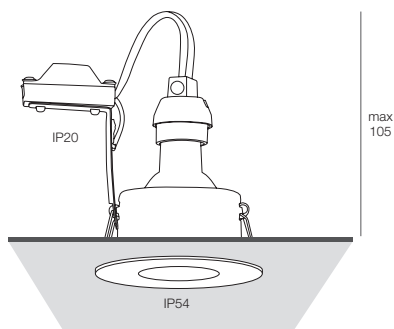

MAINS

IP  
54.01 .02 Alluminio verniciato,  
Schermo in vetro.01 .02 Painted aluminium,  
Glass screen

Ø83



## SPIRIT FRAME

   
**112302. \_\_ 01 02**
Euro / pz  
31,25

1x GU10 LED max 10W Ø51mm H55mm

MAINS

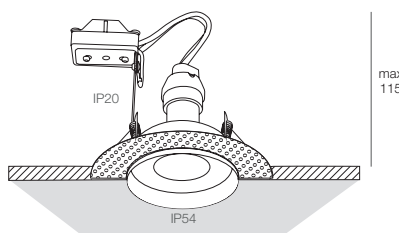
IP  
54.01 .02 Alluminio verniciato,  
Schermo in vetro.01 .02 Painted aluminium,  
Glass screenmax  
115

125

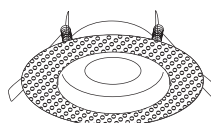

40

75



## SPIRIT FRAMELESS

   
**112301. \_\_ 01 02**
Euro / pz  
32,25

1x GU10 LED max 10W Ø51mm H55mm



# PARETE

## WALL

# COLLINS PR

Cilindri per installazione a parete ad emissione diretta ed indiretta, in acciaio verniciato texturizzato bianco, nero, grigio chiaro o grigio scuro, oppure in ottone massiccio satinato.

Cylinders for wall installation with direct and indirect emission, made of white, black, light grey or dark grey texturized painted steel, or made of satin solid brass.



## COLLEZIONE COLLINS | COLLINS COLLECTION



COLLINS SP  
Pg 20



COLLINS PL  
Pg 32

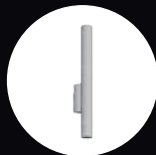

COLLINS PR  
Pg 54



MAINS

.01 .02 .23 .24 Acciaio verniciato texturizzato  
 .16 Ottone massiccio satinato

.01 .02 .23 .24 Texturized painted steel  
 .16 Satin solid brass

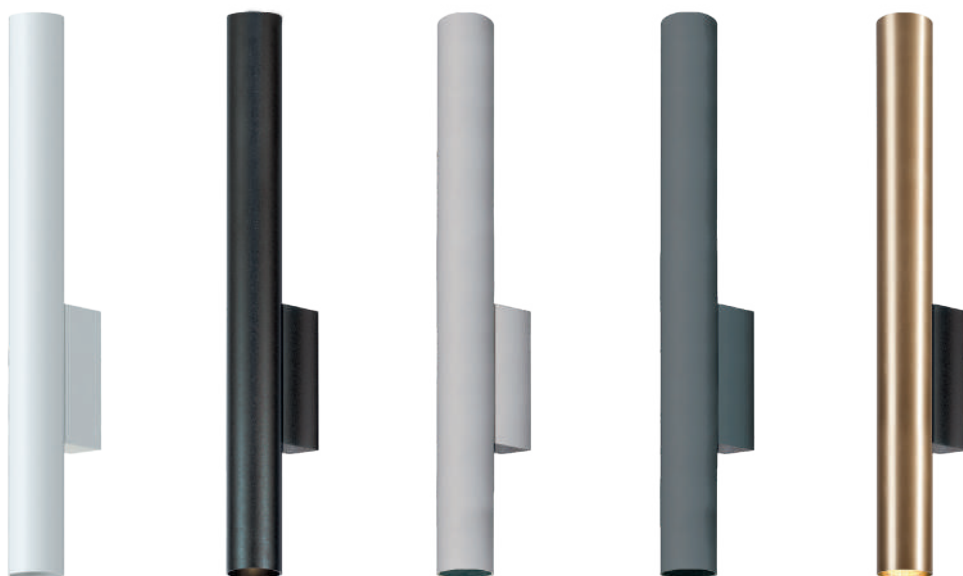

### COLLINS PR

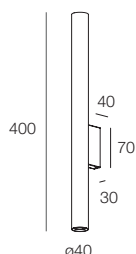

□ ■ ● ● Euro / pz  
**111811. \_\_ 01 02 23 24** 125,00

■ Euro / pz  
**111811. \_\_ 16** 154,75

1x GU10 MINI LED max 10W Ø35mm H46mm



### ACCESSORI OPZIONALI OPTIONAL ACCESSORIES

Diffusore decorativo / Decorative diffuser

■ Euro / pz  
**112901.99** 17,25

Per bianco, nero, grigio dark e grigio light / For white, black, dark grey and light grey

■ Euro / pz  
**112902.99** 17,25

Per ottone / For brass



# HONEY PR

Applique con spot orientabile in acciaio verniciato texturizzato bianco o nero oppure in ottone massiccio satinato, combinabile con basetta rettangolare da parete con portalampada, provvista di interruttore.

Applique with adjustable spot made of white or black texturized painted steel or satin solid brass, combinable with rectangular wall base with lamp holder, equipped with switch.



MADE IN EU

5 anni years



## COLLEZIONE HONEY | HONEY COLLECTION



HONEY PL  
Pg 38



HONEY IN  
Pg 46



HONEY PR  
Pg 56



HONEY PT  
Pg 64

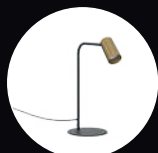

HONEY TL  
Pg 74





**PRODOTTO**  
FIXTURE



**CORPO PER SPOT**  
SPOT BODY

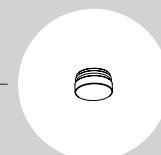

**ACCESSORI OPZIONALI**  
OPTIONAL ACCESSORIES

MAINS

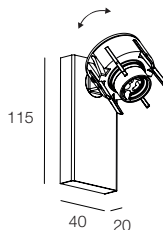
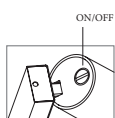

### HONEY PR

112408. \_\_ 01 02 Euro / pz  
48,50

1x GU10 LED max 10W Ø51mm H55mm

### ACCESSORI OBBLIGATORI

MANDATORY ACCESSORIES

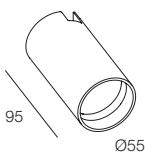

Corpo per spot / Spot body

112909. \_\_ 01 02 Euro / pz  
11,50

112909. \_\_ 16 Euro / pz  
25,50

SPOT  
.01 .02 Acciaio verniciato texturizzato  
.16 Ottone massiccio satinato

SPOT  
.01 .02 Texturized painted steel  
.16 Satin solid brass



### ACCESSORI OPZIONALI

OPTIONAL ACCESSORIES

Diffusore decorativo / Decorative diffuser

112903.99 Euro / pz  
22,00

Per spot bianco e nero / For white and black spots

112904.99 Euro / pz  
22,00

Per spot ottone / For brass spot

BASE  
.01 .02 Acciaio verniciato texturizzato

BASE  
.01 .02 Texturized painted steel



# MISS PR

Apparecchio per installazione a parete composto da braccio snodato regolabile con portalampada, su basetta provvista di interruttore. Combinabile con paralume in velluto o in tessuto, in diverse finiture.

Fixture for wall installation composed of adjustable articulated arm with lamp holder, on a base provided with a switch. Combinable with velvet or fabric lampshade, in different finishes.



## COLLEZIONE MISS | MISS COLLECTION



MISS PL  
Pg 36

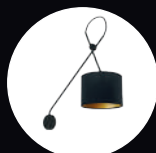

MISS PR  
Pg 58







**PRODOTTO**  
FIXTURE



**PARALUME**  
SHADE

MAINS



**STRUTTURA**  
Acciaio verniciato e  
cavo in tessuto  
.01 bianco .02 nero

**FRAME**  
Painted steel and  
fabric cable  
.01 white .02 black

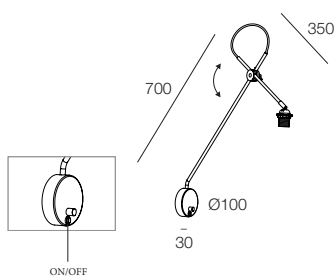

MISS PR



Euro / pz

**111602. \_\_ 01 02**

120,25

1x E27 LED max 25W

### ACCESSORI OBBLIGATORI MANDATORY ACCESSORIES

Paralume / Shade



Euro / pz

**112910. \_\_ 25 26**

74,25



**112910. \_\_ 27 28 29**

84,75

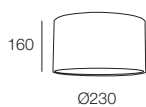

**PARALUME**  
.25 Tessuto bianco, interno bianco  
**SHADE**  
.25 White canvas, inside white



**PARALUME**  
.26 Tessuto nero, interno oro  
**SHADE**  
.26 Black canvas, inside gold



**PARALUME**  
.27 Velluto rosa, interno bianco  
**SHADE**  
.27 Pink velvet, inside white



**PARALUME**  
.28 Velluto blu, interno oro  
**SHADE**  
.28 Blue velvet, inside gold



**PARALUME**  
.29 Velluto verde, interno oro  
**SHADE**  
.29 Green velvet, inside gold

# CUBRIK

Applique rettangolare a luce radente diretta ed indiretta in acciaio verniciato in bianco, nero, grigio chiaro o grigio scuro, disponibile in due dimensioni.

Rectangular wall lamp with direct and indirect grazing light made of white, black, light grey or dark grey painted steel, available in two sizes.



MAINS

.01 .23 .24 Acciaio verniciato  
.01 .23 .24 Painted steel

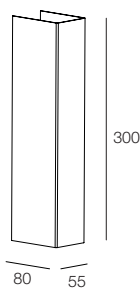
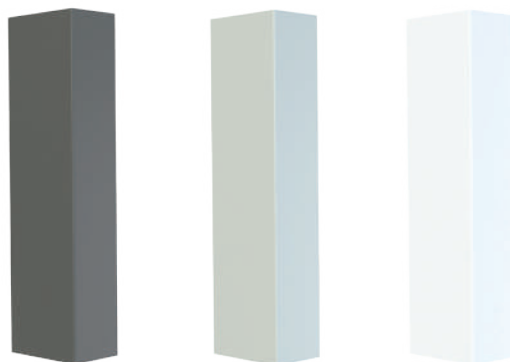

CUBRIK 55



112502. \_\_ 01 23 24

Euro / pz  
70,75

2x GU10 LED max 10W Ø51mm H55mm

MAINS

.01 .23 .24 Acciaio verniciato  
.01 .23 .24 Painted steel

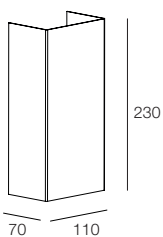

CUBRIK 110



112501. \_\_ 01 23 24

Euro / pz  
72,50

2x GU10 LED max 10W Ø51mm H55mm



**PIANTANE**  
FLOOR

# HONEY PT

Piantana composta da doppio stelo con partalampada su base rettangolare, combinabile con spot orientabili in acciaio verniciato o in ottone massiccio. Interruttore a pedale con doppia accensione.

Floor lamp composed of double stem with lamp holder on a rectangular base, combinable with adjustable spots made of painted steel or satin solid brass. Footswitches for double switch.



## COLLEZIONE HONEY | HONEY COLLECTION



HONEY PL  
Pg 38



HONEY IN  
Pg 46



HONEY PR  
Pg 56

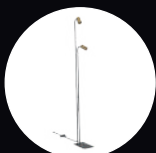

HONEY PT  
Pg 64

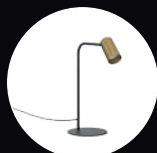

HONEY TL  
Pg 74





**PRODOTTO**  
FIXTURE



**CORPO PER SPOT**  
SPOT BODY



**ACCESSORI OPZIONALI**  
OPTIONAL ACCESSORIES

MAINS

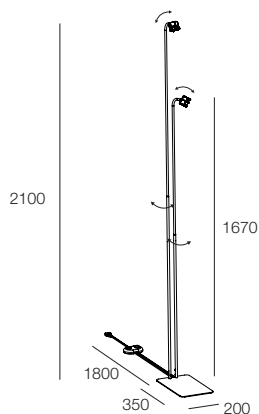

## HONEY PT

Euro / pz  
**112402. \_\_ 01 02** 279,00

Da combinare con 2 corpi per spot / To combine with 2 spot bodies  
 2x GU10 LED max 10W Ø51mm H55mm

### SPOT

.01 .02 Acciaio verniciato texturizzato  
 .16 Ottone massiccio satinato

### SPOT

.01 .02 Texturized painted steel  
 .16 Satin solid brass

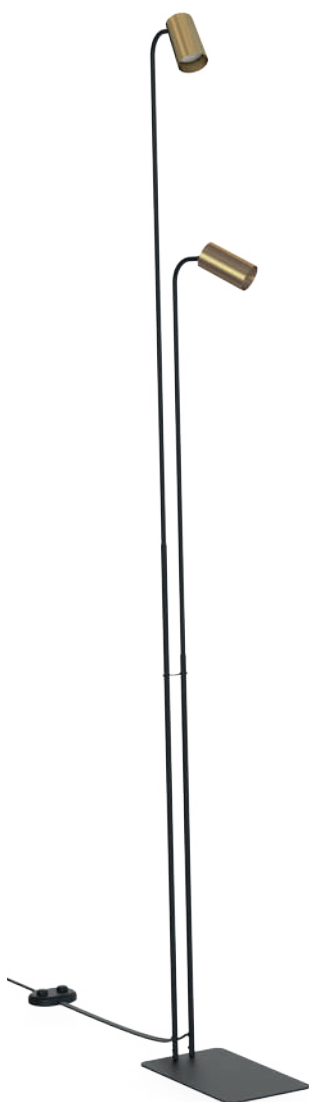

### STRUTTURA

.01 .02 Acciaio verniciato

Interruttori a pedale per doppia accensione

### FRAME

.01 .02 Painted steel

Footswitches for double switch

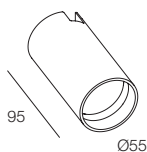

## ACCESSORI OBBLIGATORI

### MANDATORY ACCESSORIES

Corpo per spot / Spot body

Euro / pz  
**112909. \_\_ 01 02** 11,50

Euro / pz  
**112909. \_\_ 16** 25,50

## ACCESSORI OPZIONALI

### OPTIONAL ACCESSORIES

Diffusore decorativo / Decorative diffuser

Euro / pz  
**112903.99** 22,00

Per spot bianco e nero / For white and black spots

Euro / pz  
**112904.99** 22,00

Per spot ottone / For brass spot





# TINY PT

Piantana composta da stelo con portalampada su base rotonda, combinabile con paralume in velluto verde, blu o rosa, o in tessuto bianco/bianco o nero/oro. Interruttore a pedale.

Floor lamp composed of stem with lamp holder on round base, combinable with shade in green, blue or pink velvet, or in white/white or black/gold fabric. Foot switch.



## COLLEZIONE TINY | TINY COLLECTION



TINY PT  
Pg 66



TINY TL  
Pg 78





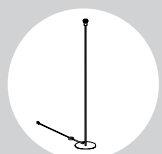

**PRODOTTO**  
FIXTURE



**PARALUME**  
SHADE

MAINS

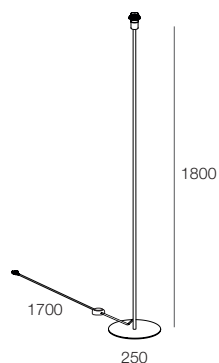

### TINY PT

112701. \_\_ 01 02

Euro / pz  
116,25

1x E27 LED max 25W

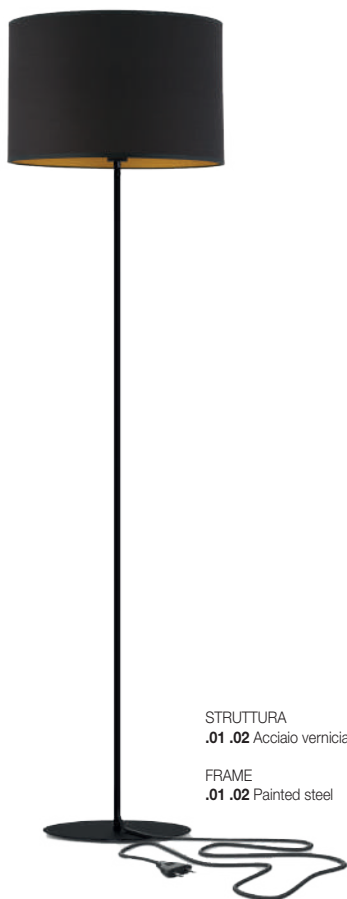

STRUTTURA  
.01 .02 Acciaio verniciato

FRAME  
.01 .02 Painted steel

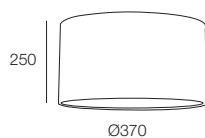

### ACCESSORI OBBLIGATORI MANDATORY ACCESSORIES

Paralume / Shade

112911. \_\_ 25 26

Euro / pz  
97,25

112911. \_\_ 27 28 29

145,00



PARALUME  
.25 Tessuto bianco, interno bianco

SHADE  
.25 White canvas, inside white



PARALUME  
.26 Tessuto nero, interno oro

SHADE  
.26 Black canvas, inside gold



PARALUME  
.27 Velluto rosa, interno bianco

SHADE  
.27 Pink velvet, inside white



PARALUME  
.28 Velluto blu, interno oro

SHADE  
.28 Blue velvet, inside gold



PARALUME  
.29 Velluto verde, interno oro

SHADE  
.29 Green velvet, inside gold

# CHANEL PT

Piantana composta da supporto a tre steli convergenti con portalampana e paralume in tessuto nero/oro. Interruttore a pedale.

Floor lamp composed of a support with three converging stems with lamp holder and lampshade in black/gold fabric. Foot switch.



## COLLEZIONE CHANEL | CHANEL COLLECTION



CHANEL PT  
Pg 68



CHANEL TL  
Pg 76



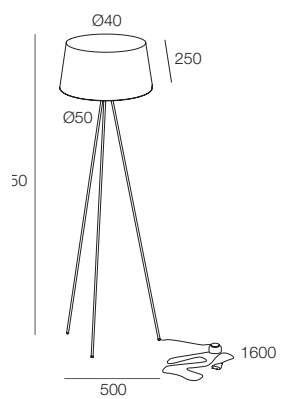

## CHANEL PT

**112601.26**

Euro / pz

253,75

1x E27 LED max 25W

PARALUME  
.26 Tessuto nero,  
interno oro

SHADE  
.26 Black canvas,  
inside gold

STRUTTURA  
Acciaio verniciato nero

FRAME  
Painted steel black

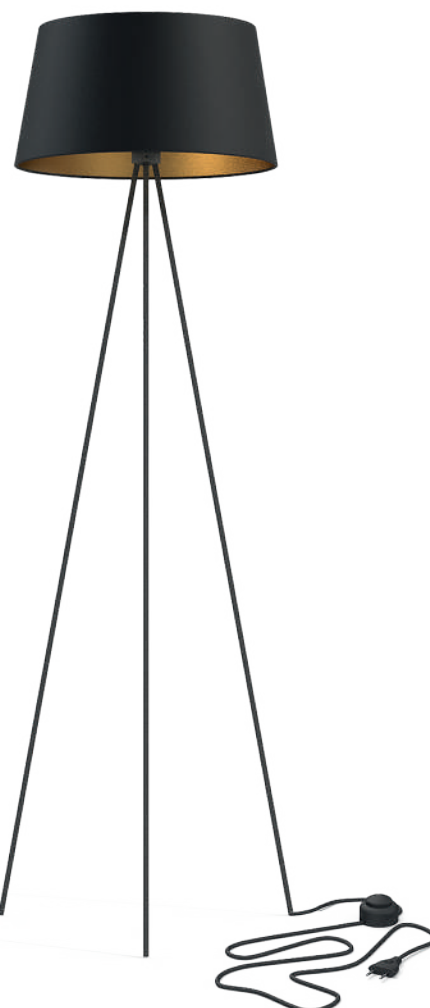

# DIANA

Piantana composta da stelo curvato con possibilità di essere orientato su base rettangolare, con portalamпада e paralume in tessuto nero/oro. Interruttore a pedale.

Floor lamp composed of curved stem with the possibility of being oriented on a rectangular base, with lamp holder and black/gold fabric lampshade. Foot switch.



MAINS

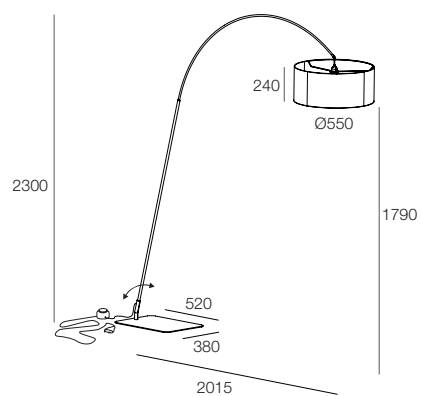

DIANA

**112801.26**

Euro / pz

612,50

 1x E27 LED max 25W

PARALUME  
**.26** Tessuto nero,  
 interno oro

SHADE  
**.26** Black canvas,  
 inside gold

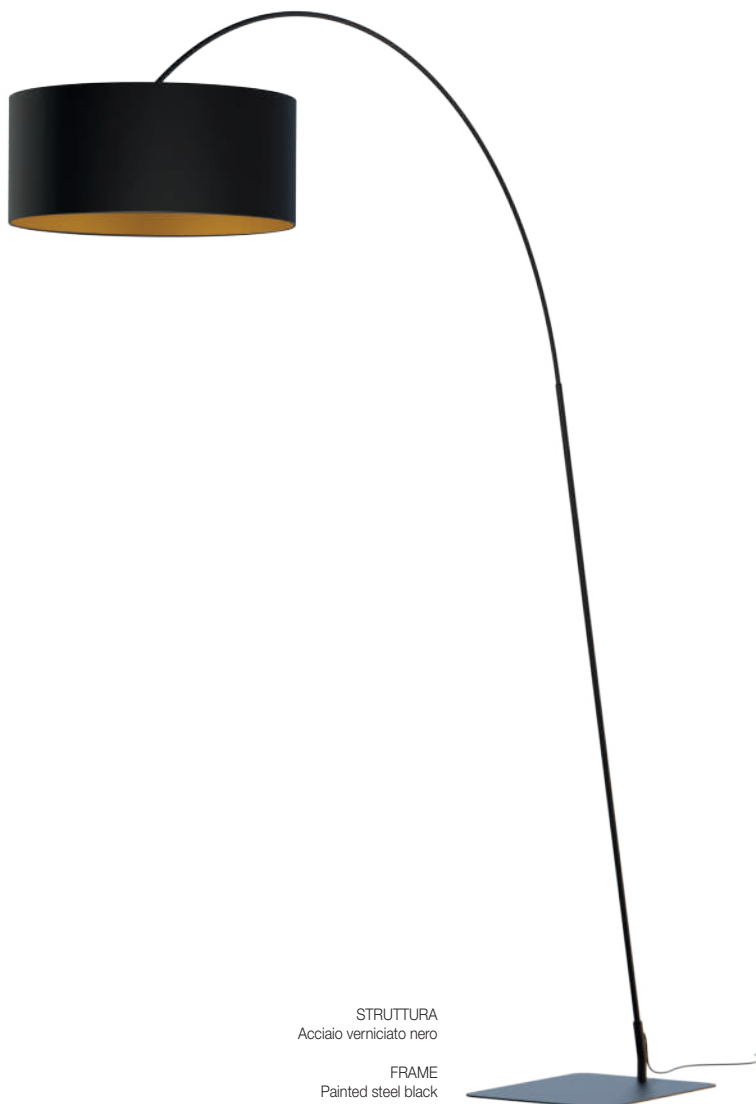

STRUTTURA  
 Acciaio verniciato nero

FRAME  
 Painted steel black



**TAVOLO**  
TABLE



# HONEY TL

Lampada da tavolo composta da braccio su base rotonda, con portalampada provvisto di interruttore, combinabile con spot orientabile in acciaio verniciato bianco o nero o in ottone massiccio.

Table lamp composed of arm on round base, with lamp holder equipped with switch, combinable with adjustable spot made of white or black texturizes painted steel or satin solid brass.



## COLLEZIONE HONEY | HONEY COLLECTION



HONEY PL  
Pg 38



HONEY IN  
Pg 46



HONEY PR  
Pg 56

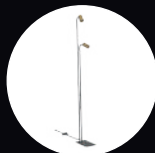

HONEY PT  
Pg 64

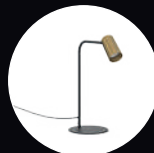

HONEY TL  
Pg 74





PRODOTTO  
FIXTURE



CORPO PER SPOT  
SPOT BODY

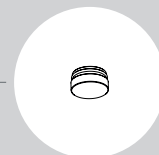

ACCESSORI OPZIONALI  
OPTIONAL ACCESSORIES

MAINS

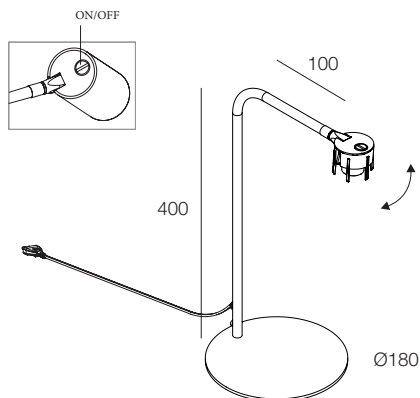

## HONEY TL

112401. \_\_ 01 02 Euro / pz  
114,00

1x GU10 LED max 10W Ø51mm H55mm

## ACCESSORI OBBLIGATORI MANDATORY ACCESSORIES

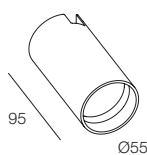

Corpo per spot / Spot body

112909. \_\_ 01 02 Euro / pz  
11,50

112909. \_\_ 16 Euro / pz  
25,50

## ACCESSORI OPZIONALI OPTIONAL ACCESSORIES

Diffusore decorativo / Decorative diffuser

112903.99 Euro / pz  
22,00

Per spot bianco e nero / For white and black spots

112904.99 Euro / pz  
22,00

Per spot ottone / For brass spot

SPOT  
.01 .02 Acciaio verniciato texturizzato  
.16 Ottone massiccio satinato

SPOT  
.01 .02 Texturized painted steel  
.16 Satin solid brass



STRUTTURA  
.01 .02 Acciaio verniciato

STRUCTURE  
.01 .02 Painted steel

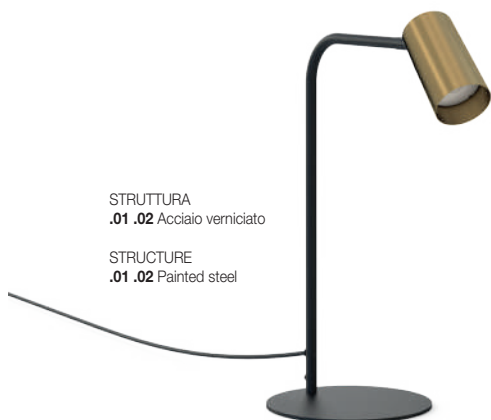

# CHANEL TL

Lampada da tavolo composta da supporto a tre steli convergenti con portalampana e paralume in tessuto nero/oro. Provisto di cavo di alimentazione con interruttore.

Table lamp composed of a support with three converging stems with lamp holder and lampshade in black/gold fabric. Equipped with power cable with switch.



MADE IN EU

5 anni years



## COLLEZIONE CHANEL | CHANEL COLLECTION



CHANEL PT  
Pg 68



CHANEL TL  
Pg 76





PARALUME  
**.26** Tessuto nero,  
 interno oro

SHADE  
**.26** Black canvas,  
 inside gold

STRUTTURA  
**.01 .02** Acciaio verniciato

FRAME  
**.01 .02** Painted steel

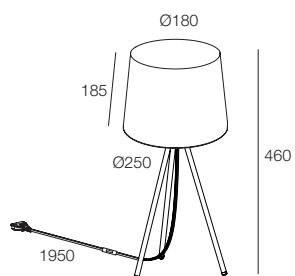

## CHANEL TL

**112602. 26**

Euro / pz  
 160,00

💡 1x E27 LED max 25W



# TINY TL

Lampada da tavolo composta da stelo con portalampada su base rotonda, combinabile con paralume in velluto verde, blu o rosa, o in tessuto bianco/bianco o nero/oro.

Table lamp composed of stem with lamp holder on round base, combinable with shade in green, blue or pink velvet, or in white/white or black/gold fabric.



## COLLEZIONE TINY | TINY COLLECTION



TINY PT  
Pg 66



TINY TL  
Pg 78





PRODOTTO  
FIXTURE

+

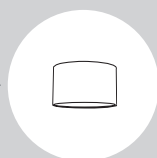

PARALUME  
SHADE

MAINS

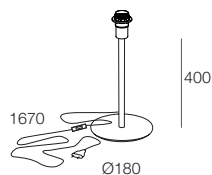

### TINY TL

112702. \_\_ 01 02

Euro / pz  
70,75

1x E27 LED max 25W

### ACCESSORI OBBLIGATORI MANDATORY ACCESSORIES

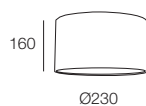

#### Paralume / Shade

112910. \_\_ 25 26

Euro / pz  
74,25

112910. \_\_ 27 28 29

84,75

STRUTTURA  
.01 .02 Acciaio verniciato

FRAME  
.01 .02 Painted steel



PARALUME  
.25 Tessuto bianco, interno bianco  
SHADE  
.25 White canvas, inside white



PARALUME  
.26 Tessuto nero, interno oro  
SHADE  
.26 Black canvas, inside gold



PARALUME  
.27 Velluto rosa, interno bianco  
SHADE  
.27 Pink velvet, inside white



PARALUME  
.28 Velluto blu, interno oro  
SHADE  
.28 Blue velvet, inside gold



PARALUME  
.29 Velluto verde, interno oro  
SHADE  
.29 Green velvet, inside gold

CODICE / CODE	PG
111601.01	37
111601.02	37
111602.01	59
111602.02	59
111701.23	29
111701.24	29
111702.23	29
111702.24	29
111703.23	29
111703.24	29
111801.01	22
111801.02	22
111801.16	22
111801.23	22
111801.24	22
111802.01	22
111802.02	22
111802.16	22
111802.23	22
111802.24	22
111803.01	22
111803.02	22
111803.16	22
111803.23	22
111803.24	22
111804.01	22
111804.02	22
111804.16	22
111804.23	22
111804.24	22
111805.01	33
111805.02	33
111805.16	33
111805.23	33
111805.24	33
111806.01	33
111806.02	33
111806.16	33
111806.23	33
111806.24	33
111807.01	33
111807.02	33
111807.16	33
111807.23	33
111807.24	33
111808.01	34
111808.02	34
111808.16	34
111808.23	34

CODICE / CODE	PG
111808.24	34
111809.01	34
111809.02	34
111809.16	34
111809.23	34
111809.24	34
111810.01	34
111810.02	34
111810.16	34
111810.23	34
111810.24	34
111811.01	55
111811.02	55
111811.16	55
111811.23	55
111811.24	55
111901.16	27
111901.23	27
111901.24	27
112001.01	43
112001.02	43
112002.01	43
112002.02	43
112101.01	49
112101.02	49
112102.01	49
112102.02	49
112301.01	51
112301.02	51
112302.01	51
112302.02	51
112401.01	75
112401.02	75
112402.01	65
112402.02	65
112403.01	40
112403.02	40
112404.01	47
112404.02	47
112405.01	40
112405.02	40
112406.01	40
112406.02	40
112407.01	40
112407.02	40
112408.01	57
112408.02	57
112501.01	61
112501.23	61

CODICE / CODE	PG
112501.24	61
112502.01	61
112502.23	61
112502.24	61
112601.26	69
112602.26	77
112701.01	67
112701.02	67
112702.01	79
112702.02	79
112801.26	71
112901.99	23
112902.99	23
112903.99	23
112904.99	23
112905.01	23
112905.02	23
112905.23	23
112905.24	23
112906.01	23
112906.02	23
112906.23	23
112906.24	23
112907.01	23
112907.02	23
112907.23	23
112907.24	23
112908.01	23
112908.02	23
112908.23	23
112908.24	23
112909.01	41
112909.02	41
112909.16	41
112910.25	59
112910.26	59
112910.27	59
112910.28	59
112910.29	59
112911.25	37
112911.26	37
112911.27	37
112911.28	37
112911.29	37





# CONDIZIONI GENERALI DI VENDITA

**VALIDITÀ LISTINO** Il presente listino prezzi sostituisce ed annulla tutte le precedenti edizioni. E' espressamente vietata la riproduzione anche parziale di figure e descrizioni riportate nella ns. documentazione commerciale, cartacea e telematica. L'Azienda si riserva in qualsiasi momento, senza preavviso ed obbligo di comunicazione, la facoltà di effettuare modifiche e/o aggiornamenti relativi a prodotti o a quant'altro indicato nella documentazione stessa, secondo le esigenze di fabbricazione e per il perfezionamento degli apparecchi.

**ORDINI** Importo minimo d'ordine e di fatturazione € 150,00 netto IVA esclusa. Gli ordini verranno evasi secondo le richieste dei clienti; eventuali alternative al prodotto richiesto verranno fornite solo dopo averne dato comunicazione al cliente ed aver ricevuto la sua approvazione.

**PREZZI** I prezzi di listino si intendono IVA ESCLUSA; ci riserviamo la facoltà di modificare i medesimi in base all'andamento dei costi o qualsivoglia altra necessità aziendale. L'Imposta sul Valore Aggiunto è sempre a carico del committente.

**TERMINI DI CONSEGNA** I termini di consegna delle merci sono indicativi e non sono mai vincolanti per la ditta fornitrice; eventuali ritardi o mancate spedizioni non possono dare luogo a contestazioni o penali di alcun genere.

**TRASPORTO** La merce viene spedita in PORTO FRANCO per ordini di importo superiori a € 775,00 netto merce IVA esclusa.

**RECLAMI** I reclami devono essere DOCUMENTATI e fatti pervenire in Novalux S.r.l. entro 8 gg. dal ricevimento della merce. Trascorso questo termine non si accettano reclami; detto reclamo non dà diritto alla sospensione dei pagamenti. Le richieste per danneggiamenti dovuti al trasporto devono essere inoltrate a Novalux S.r.l. allegando DDT riportante riserva specifica entro e non oltre 8 gg. dal ricevimento del materiale.

**RESI** Eventuali resi di materiale dovranno essere sempre autorizzati per iscritto dall'azienda Novalux S.r.l. secondo le regole aziendali. Per i dettagli richiedere il documento a Novalux.

**GARANZIA** Il materiale venduto dalla società Novalux S.r.l. è garantito da eventuali difetti di fabbricazione secondo i termini di legge. Tale garanzia decorre dalla data di spedizione della merce indicata sul d.d.t. , e non può prolungarsi per l'inattività dell'apparecchio a causa della riparazione. La garanzia copre esclusivamente i guasti riferiti al prodotto che ne determinino un cattivo funzionamento; sarà comunque esclusiva facoltà della società Novalux S.r.l. decidere se effettuare l'intervento alla sole parti danneggiate o sostituire integralmente il prodotto.

La garanzia non si applica in caso di danni provocati da incuria, uso o installazione non conformi alle istruzioni fornite, danni causati da errati interventi, danni dovuti a cause accidentali, o a negligenze dell'acquirente con particolare riferimento alle parti esterne.

Inoltre non si applica in caso di guasti conseguenti a collegamenti dell'apparecchio a tensioni diverse da quelle indicate oppure a improvvisi mutamenti di tensioni nella rete cui l'apparecchio è collegato, così come in caso di guasti causati da scariche induttive/elettrostatiche o scariche provocate da fulmini o altri fenomeni esterni all'apparecchio. Sono escluse dalla garanzia le parti soggette ad usura in seguito all'utilizzo, come: lampade, starter e batterie quando fornite in dotazione. Per eventuali danni a persone, cose, animali, che dovessero direttamente o indirettamente derivare dall'uso improprio dell'apparecchio, la società Novalux S.r.l. declina ogni responsabilità.

**NORME DI SICUREZZA** I prodotti nella loro versione standard sono conformi alle Direttive Comunitarie Europee "CE".

**PAGAMENTI** La Società Novalux S.r.l., si riserva la proprietà esclusiva del materiale venduto fino all' avvenuto pagamento del prezzo relativo all'intero ammontare della fornitura. I pagamenti sono validi solo se effettuati direttamente al nostro domicilio o a persone/società da noi autorizzate. Il protrarsi di mancati pagamenti alla scadenza stabilita ci autorizzerà a sospendere l'evasione di eventuali ordini in corso e a revocare con effetto retroattivo l'eventuale "sconto cassa" indicato in fattura.

**INFORMATIVA AI SENSI DEL D.LGS. 196 DEL 30-06-2003** Ai sensi del D. Lgs. 196 del 30 giugno 2003, il trattamento dei dati anagrafici forniti avrà luogo c/o la Sede della Società Novalux S.r.l. L'archiviazione dei dati sarà eseguita su supporti cartacei e/o magnetici, al fine di consentire alla società Novalux S.r.l. di eseguire gli obblighi strettamente correlati all'esecuzione degli ordini e delle relative comunicazioni agli Istituti Bancari di cui usualmente ci avvaliamo.

**CONTROVERSIE** Per ogni controversia si stabilisce la competenza dell'Autorità Giudiziaria di Bologna.

# GENERAL TERMS & CONDITIONS OF SALE

**VALIDITY OF THE PRICE LIST** The present price list replaces and supersedes all the previous editions. Any reproduction, even partial, of pictures and descriptions mentioned in our commercial documentation, both paper copy or telematic copy, is clearly forbidden. The Company reserves at any moment the right to make modifications or/and updates relating to the products or to any other item indicated in the same documentation, based on production needs and in order to improve the fixtures.

**ORDERS** Minimum of order EUR 250,00 net invoiced. Orders will be supplied on the basis of the Clients' requests. Any alternatives to the ordered products may be supplied only after communicating them to the Client and upon receiving the Client's approval.

**PRICES** The price list reports gross prices excluding VAT. The Company reserves the right to modify the same prices in base of the costs trend or whatever Company necessity.

**DELIVERIES** Delivery times are always indicative and never binding for the Company; eventual delays or missing shipments cannot entail contestations or penalties of any kind.

**TRANSPORT** The goods are delivered Ex-Works in Fano di Argelato. The prices reported in this price list do not include the transport.

**CLAIMS** Claims must be DOCUMENTED and addressed to the Company within 8 working days from the goods receipt. Beyond this term, any claims will be rejected. The claim does not give the right of payment suspension. Any damages occurred during the transportation cannot be charged to the Company and must be addressed to the Forwarder.

**RETURN OF GOODS** Any return of products must follow a RMA Return Merchandise Authorization written by the Company in accordance with the company policy. Details should be requested from Novalux.

**WARRANTY** Products sold by the Company are guaranteed from eventual fabrication defect on the basis of the terms of law. The warranty starts from the date of shipment as reported on the bill of transportation, and cannot be extended to cover the period of inactivity of the products due to repair. The warranty covers exclusively those failures that result in the product malfunctioning. The Company will keep the exclusive right to evaluate whether to fix the sole damaged parts, or to replace the entire products.

The warranty doesn't cover the damages caused by negligence, usage or installation not in conformity with instructions sheets, or caused by mistaken actions, accidental causes, or negligence of the Client with particular reference to the external parts. The warranty is furthermore not applicable to the failures caused by electrical connections to voltages different from those indicated or by sudden fluctuations of tension, as well as by inductive/electrostatic discharges or lightning. The warranty doesn't cover the parts subject to wear, i.e.: bulbs, starters and batteries. In case of damages to people, things or animals, caused directly or indirectly by improper usage of the products, the Company will deny any liability.

**SAFETY STANDARD** The products in their standard version are in conformity with European Community directives "CE".

**PAYMENTS** The Company reserves itself the property of the sold products until the full payment of the entire invoiced sum. Payments are effective only if remitted directly to the Company or to people/societies authorized by the Company. Perpetuation of missing payments beyond the agreed deadline will authorize the Company to hold any further order and to revoke any additional discount for advanced payment even if written on the invoice.

**INFORMATION SUBJECT TO DECREE 196 OF 30-06-2003** As per Decree 196 of 30th of June 2003, data&information provided to Novalux will be handled in the headquarters of Novalux S.r.l. Archiving of data will be performed in hard or soft copies, in order to allow Novalux S.r.l. , to fulfil its obligations strictly related to completion of orders and related communications to Banks and financial institutions with whom the Company regularly works.

**DISPUTES** For any dispute, the competent authority is the law courts of Bologna.

Il presente documento potrebbe includere inesattezze tecniche o errori tipografici che verranno corretti a esclusiva discrezione di Novalux srl non appena saranno rilevati. Novalux srl si riserva inoltre il diritto di cambiare i contenuti del documento in qualsiasi momento, senza preavviso.

Con la tecnologia attuale non è possibile mostrare l'esatta qualità delle immagini dei prodotti come questi appaiono dal vivo. Le immagini presentate pertanto sono solo a scopo illustrativo e per finalità promozionali.

Tutti i contenuti presenti su questa pubblicazione, nonché il design della stessa, appartengono unicamente a Novalux srl oppure a società collegate e/o controllate e sono protetti dalla normativa dettata in materia di tutela della proprietà intellettuale e del diritto d'autore. È pertanto vietato modificare, copiare, riprodurre, distribuire, trasmettere o diffondere senza autorizzazione ogni suo contenuto.

The present document may include some technical inaccuracies or typing errors that will be amended exclusively at novaluxdiscretion as soon as they will be noticed.

Also Novalux srl reserves the right to modify the document contents at any time, without advanced notice.

The actual technology does not allow to display the same exact quality of the product pictures as they appear in reality. These pictures are displayed only for demonstration purpose and for promotional scope.

All the contents present in this publication, including the same graphics, belong exclusively to Novalux srl or to companies associate or subsidiary of Novalux and are protected by the laws inherent the intellectual property rights and the copyright. Therefore it's forbidden modifying, copying, reproducing, distributing, transmitting or disclosing without authorization every own content.

Marzo 2024





